

DESIGN GUIDELINES FOR HISTORIC PROPERTIES

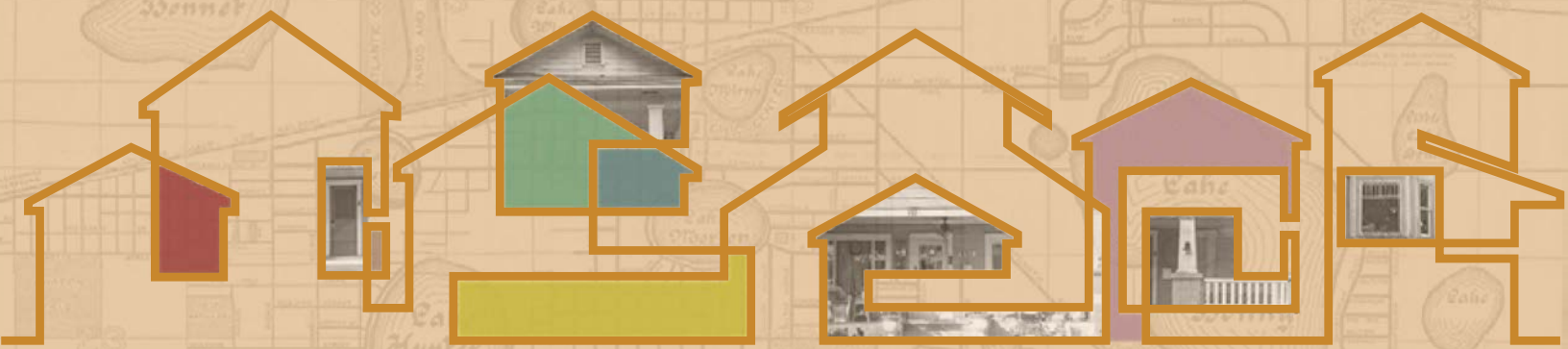

CITY OF LAKE LAND



ISSUED BY PALM CITY DISTRICT
CHAMBER OF COMMERCE
MAP OF
LAKE LAND
FLORIDA

LEGEND
Paved Streets
Streets not Paved
Lake Harbor School
Lake Shore School
Lake Morton School
Shore Area School
Meyer Archibald School
CITY Hall
Library
Marble Arcade Bldg
Cleveland Wm. Club House
Hospital
Cleveland Hospital
Hotel Terrace
Hotel Theresa
Hotel Regency
Post Office

COMPILED
BY
D. DANDMENDENHALL
MAY
1925

ACKNOWLEDGEMENTS

This document is the result of the collaborative effort between the City of Lakeland Community and Economic Development Department's Planning and GIS Division, the Lakeland Historic Preservation Board, Furr, Wegman & Banks Architects, P.A., and the University of South Florida's School of Architecture and Community Design. Greatly appreciated is the cooperation and valuable input provided by property owners of the historic districts, Historic Lakeland, Inc., and several other individuals interested in the City's historic preservation efforts, in the creation of these Historic Design Guidelines.



City Commission

Bill Mutz, *Mayor*
Scott Franklin
Stephanie Madden
Chad McLeod
Sara Roberts McCarley
Bill Read
Phillip Walker

Community & Economic Development

Nicole Travis, *Director*
Teresa Maio, *Planning and Housing Manager*
Matthew Lyons, *Chief Planner*
Emily Foster, *Senior Planner, Historic Preservation*

Furr, Wegman & Banks Architects, P.A.

Philip Wegman, *Principal Architect*
Aaron Banks, *Principal Architect and Project Manager*

Adopted (12/17/2020)

All images are courtesy of the City of Lakeland, Furr, Wegman & Banks Architects, P.A., and USF SACD etc. unless otherwise noted.

All historic photographs are courtesy of the Lakeland Library's Lakeland History Room digital archives.

Historic Preservation Board

Tim Calhoon, *Chair*
Kyle Clyne, *Vice Chair*
Lynn Dennis
Dan Fowler
Jeremy Moses
Ursula Radabaugh
MeLynda Rinker
Nick Thomas
Linda Trumble
John White

University of South Florida's School of Architecture and Community Design

T. Trent Green, *R.A.*
Anastasiia Hunda
Kamani Samuel
Keisha Belizaire
Matthew Satchwell
Mitali Naik
Olivia Leamer
Sreen Abuemaish

This document was sponsored in part from a Small Matching Grant provided by the Department of State, Division of Historical Resources and the State of Florida.

TABLE OF CONTENTS

DESIGN GUIDELINES FOR HISTORIC PROPERTIES



- Introduction.....2**
- 1.1 Purpose of the Design Guidelines.....3**
- 1.2 Policy and Regulatory Framework5**
 - 1.2.1 Land Development Code5
 - 1.2.2 Secretary of the Interior’s Standards for the Treatment of Historic Properties5
 - 1.2.3 Historic Designation: Local Versus National Register of Historic Places11
- 1.3 Using the Guidelines..... 12**
 - 1.3.1 Applicability..... 12
 - 1.3.2 Property Classifications (Contributing and Non-Contributing)..... 14
- 1.4 How to Use this Document..... 17**

2



**DESIGN
REVIEW
PROCESS**

2.1 Design Review and Certificate of Review Process20

2.2 Understanding the Design Review Process21

 2.2.1 Preliminary Review23

 2.2.2 Minor Review23

 2.2.3 Major Review25

2.3 Design Review Process-Frequently Asked Questions.....28

3



**HISTORIC
DISTRICTS**

Historic Districts and Other Historic Properties30

3.1 Munn Park Historic District31

3.2 Beacon Hill Historic District34

3.3 Biltmore-Cumberland Historic District37

3.4 Dixieland Historic District40

3.5 Lake Hunter Terrace Historic District44

3.6 South and East Lake Morton Historic Districts47

3.7 Other Historic Resources53

4



HISTORICAL DEVELOPMENT PATTERNS AND NEW CONSTRUCTION

4.1	Residential Zoning in Historic Districts	60
4.2	Commercial Zoning in Historic Districts	61
4.3	Public Rights of Way	62
4.3.1	Historic Brick Streets	63
4.3.2	Alleys.....	64
4.4	Understanding Neighborhood Form	65
4.5	Additions	67
4.6	New Residential Construction and Infill Development	71
4.6.1	Residential Infill	72
4.6.2	New Construction.....	73
4.6.3	Single Lot Infill	74
4.6.4	Setbacks	75
4.6.5	Orientation	77
4.6.6	Massing and Scale.....	79
4.6.7	Facade Proportions for Infill Development	81
4.6.8	Compatible Facade Details for Single and Multi-Family Infill Structures	84
4.6.9	Arrangement of Porch Columns and Wall Openings	85
4.6.10	Porch Columns and Beam Details	87
4.6.11	Window Configurations.....	89
4.6.12	Eaves and Returns	91

4.7	Multi-Family Infill	93
4.7.1	Duplexes	94
4.7.2	Townhouses	97
4.7.3	Apartment Buildings	99
4.7.4	Multi-Use Buildings	101
4.8	Adaptive Use	103
4.9	Accessory Structures	105
4.9.1	Accessory Dwelling Units	106
4.9.2	Secondary Structures	108
4.10	Garages, Carports, and Porte Cocheres	110
4.11	Site Elements	113
4.11.1	Landscape Features	114
4.11.2	Fences and Walls.....	115
4.11.3	The Design and Placement of Fences.....	116
4.11.4	Sidewalks and Driveways.....	117
4.11.5	Off-Street Parking.....	118
4.12	Understanding Commercial Area Form	121
4.12.1	Commercial Block Organization.....	122
4.12.2	Historic Commercial Building Classification ..	123
4.12.3	Historic Commercial Building Facades and Architectural Style	124
4.12.4	New Construction and Infill Development	126
4.12.5	Preserving Historic Commercial Facades	128

5

**HOUSE
 STYLES**

4.12.6 Cornices128
 4.12.7 Wall Articulation.....130
 4.12.8 Windows and Details.....132
 4.12.9 Window Film Policy.....133
 4.12.10 Signage and Awnings135
 4.12.11 Storefronts.....139

5.1 House Styles in Lakeland’s Historic Districts.....143
 Historic House Styles Timeline144
 House Styles Matrix145
5.2 Frame Vernacular148
5.3 Bungalow / Craftsman.....151
5.4 Mediterranean Revival / Spanish Colonial154
5.5 Colonial Revival157
5.6 Queen Anne160
5.7 Four Square163
5.8 Greek Revival166
5.9 Neo-Classical169
5.10 Modern.....171
 5.10.1 Modern / Minimal Traditional172
 5.10.2 Modern / Hip Cottage.....174
 5.10.3 Modern / Ranch176
 5.10.4 Modern Vernacular (Frame and Masonry)178

5.11	Tudor	180
5.12	Other Unique Styles	182
5.12.1	Prairie	182
5.12.2	Dutch Colonial	183

6



**EXTERIOR
ARCHITECTURAL
FEATURES:
ALTERATION AND
MAINTENANCE**

General Guidelines	188	
6.1	Roofs and Eaves	189
6.1.1	Flat Roofs	190
6.1.2	Gable Roofs	191
6.1.3	Hip Roofs	192
6.1.4	Other Common Roof Types	194
6.1.5	Roof Materials	195
6.1.6	Chimneys	199
6.1.7	Eaves and Overhangs	201
6.2	Porches	204
6.2.1	Porch Types	205
6.2.2	Porch Features	206
6.2.3	Screen Porches	208
6.2.4	Foundations and Crawl Space Screening	210
6.2.5	Front Porch Restoration and Rehabilitation	211
6.3	Front Doors and Entrances	215

6.4 Windows and Shutters221

6.4.1 Stained Glass Window Guidelines227

6.5 Siding and Exterior Wall Cladding.....231

6.6 Awnings and Canopies234

6.7 House Numbers and Historical Markers.....237

6.8 Accessibility Ramps239

6.9 Paint.....241

6.9.1 Exterior Paint Colors.....242

6.10 Mechanical Systems, Utilities and Appurtenances244

6.11 Hurricane Protection245

6.12 Relocation and Demolition246

7



**PROJECT
PLANNING**

7.1 Project Planning.....249

7.2 Inspection Checklist.....250

7.3 Project Planning Checklist.....253

8



APPENDIX

8.1	Glossary	258
8.2	Historic Designation	267
8.3	Florida Historical Contexts Relevant to Lakeland’s History	269
8.4	Sustainability and Energy Retrofits.....	277
8.5	Environmental Issues.....	277
8.5.1	Asbestos Shingle Roofing and Siding	282
8.5.2	Lead Paint Abatement.....	290
8.6	Resources and Works Referenced.....	295

LIST OF FIGURES

<i>Figure 1.1: Extent of Design Guidelines</i>	13	<i>Figure 4.13: Building Setbacks Should be Consistent along a Neighborhood Street.</i>	75
<i>Figure 1.2: Preserving Architectural Integrity</i>	15	<i>Figure 4.14: Street-Facing House Orientation</i>	77
<i>Figure 1.3: Info-Graphic Historic Preservation in Lakeland by the Numbers</i>	16	<i>Figure 4.15: Massing and Scale Along the Street</i>	79
<i>Figure 2.1: Design Review Process</i>	22	<i>Figure 4.16: Façade Proportions of Different House Styles</i>	81
<i>Figure 3.1: Lakeland Historic Districts Map</i>	30	<i>Figure 4.17: Diagrammatic Compatibility</i>	82
<i>Figure 3.2: Munn Park Historic District Map</i>	33	<i>Figure 4.18: Regular Arrangement of Porch Columns and Wall Openings</i>	85
<i>Figure 3.3: Beacon Hill Historic District Map</i>	36	<i>Figure 4.19: Acceptable and Not Acceptable Column Details</i>	87
<i>Figure 3.4: Biltmore-Cumberland Historic District Map</i>	39	<i>Figure 4.20: Acceptable Window Configurations</i>	89
<i>Figure 3.5: Dixieland Historic District Map</i>	42	<i>Figure 4.21: Acceptable and Not Acceptable Eave Brackets</i>	91
<i>Figure 3.6: Lake Hunter Terrace Historic District Map</i>	46	<i>Figure 4.22: Duplex Infill Development</i>	94
<i>Figure 3.7: South Lake Morton Historic District Map</i>	50	<i>Figure 4.23: Townhouse Infill Development</i>	97
<i>Figure 3.8: East Lake Morton Historic District Map</i>	51	<i>Figure 4.24: Apartment Building Infill Development</i>	99
<i>Figure 3.9: Garden District Sub-Districts Map</i>	52	<i>Figure 4.25: Multi-Use Infill Development</i>	101
<i>Figure 4.1: Zoning Map within Historic Districts</i>	61	<i>Figure 4.26: Accessory Dwelling Unit</i>	106
<i>Figure 4.2: Historic Brick Streets</i>	63	<i>Figure 4.27: Garage Apartment</i>	106
<i>Figure 4.3: Alleys in Historic Districts</i>	64	<i>Figure 4.28: Secondary Structure, Tool Shed or Workshop</i>	108
<i>Figure 4.4: Typical Block Face with Historic Houses</i>	66	<i>Figure 4.29: Garages, Carport, and Porte Cochere</i>	110
<i>Figure 4.5: Addition to Existing Historic House</i>	67	<i>Figure 4.30: Off-Street Parking</i>	118
<i>Figure 4.6: Side and Rear Additions Options for a Bungalow Structure</i>	69	<i>Figure 4.31: Acceptable Front Yard Conditions</i>	120
<i>Figure 4.7: Side and Rear Addition Options for a Four Square Structure</i>	69	<i>Figure 4.32: Not Acceptable Front Yard Conditions</i>	120
<i>Figure 4.8: Side and Rear Additions for a Frame Vernacular Structure</i>	69	<i>Figure 4.33: Historic Sanborn Map of the Munn Park/ Downtown Historic District.</i>	121
<i>Figure 4.9: New Construction</i>	71	<i>Figure 4.34: Street View of Historic Block Face along N. Kentucky Avenue.</i>	121
<i>Figure 4.10: Neighborhood Lot Types</i>	72	<i>Figure 4.35: Typical Commercial Block Face</i>	122
<i>Figure 4.11: Residential Infill Development and New Construction</i>	73	<i>Figure 4.36: Typical Historic Commercial Block Organization</i>	122
<i>Figure 4.12: Single-Family Infill</i>	74		

<i>Figure 4.37: Historic Commercial Block Face</i>	122	<i>Figure 5.6: Bungalow / Craftsman Facade Features</i>	152
<i>Figure 4.38: Two-Part Commercial Block</i>	123	<i>Figure 5.7: Bungalow / Craftsman House Style and Neighborhood Context</i>	153
<i>Figure 4.39: Business Block Historic Landmark</i>	123	<i>Figure 5.8: Facade Conditions from Mediterranean Revival / Spanish Colonial House Styles</i>	154
<i>Figure 4.40: Typical Historic Commercial Façade Features</i>	124	<i>Figure 5.9: Mediterranean Revival / Spanish Colonial Facade Features</i>	155
<i>Figure 4.41: Commercial Façade Horizontal and Vertical Orientation</i>	125	<i>Figure 5.10: Mediterranean Revival / Spanish Colonial House and Neighborhood Context</i>	156
<i>Figure 4.42: Commercial Façade Fenestration Patterns</i>	125	<i>Figure 5.11: Facade Conditions from Colonial Revival House Styles</i>	157
<i>Figure 4.43: Commercial Infill Conditions</i>	126	<i>Figure 5.12: Colonial Revival Facade Features</i>	158
<i>Figure 4.44: Acceptable and Not Acceptable Setbacks for Commercial Infill</i>	127	<i>Figure 5.13: Colonial Revival House and Neighborhood Context</i>	159
<i>Figure 4.45: Historic Commercial Building Cornice Details</i>	128	<i>Figure 5.14: Facade Conditions from Queen Anne House Styles</i>	160
<i>Figure 4.46: Historic Commercial Building Wall Articulation</i>	130	<i>Figure 5.15: Queen Anne Facade Features</i>	161
<i>Figure 4.47: Historic Commercial Building Windows and Details</i>	132	<i>Figure 5.16: Queen Anne House and Neighborhood Context</i>	162
<i>Figure 4.48: Window Film Properties</i>	133	<i>Figure 5.17: Facade Conditions from Four Square House Styles</i>	163
<i>Figure 4.49: Historic Commercial Building Signage and Awnings</i>	136	<i>Figure 5.18: Four Square Facade Features</i>	164
<i>Figure 4.50: Types of Awnings</i>	137	<i>Figure 5.19: Four Square House and Neighborhood Context</i>	165
<i>Figure 4.51: Historic Commercial Building Storefronts</i>	139	<i>Figure 5.20: Facade Conditions from Greek Revival House Style</i>	166
<i>Figure 4.52: Original Storefront Location</i>	140	<i>Figure 5.21: Greek Revival Facade Features</i>	167
<i>Figure 4.53: Relocated Storefront</i>	140	<i>Figure 5.22: Greek Revival House and Neighborhood Context</i>	168
<i>Figure 5.1: Historic House Styles Timeline</i>	144	<i>Figure 5.23: Facade Conditions from Neo-Classical House Style</i>	169
<i>Figure 5.2: Facade Conditions from Frame Vernacular House Styles</i>	148	<i>Figure 5.24: Neo-Classical Facade Features</i>	170
<i>Figure 5.3: Frame Vernacular Facade Features</i>	149	<i>Figure 5.25: Neo-Classical House and Neighbor- hood Context</i>	170
<i>Figure 5.4: Frame Vernacular House and Neighborhood Context</i>	150		
<i>Figure 5.5: Facade Conditions from Bungalow / Craftsman House Styles</i>	151		

<i>Figure 5.26: Minimal Traditional</i>	171	<i>Figure 6.12: Common Porch Features on Different Historic House Styles</i>	206
<i>Figure 5.28: Ranch</i>	171	<i>Figure 6.13: Bungalow and Craftsman Porch Column Variations</i>	207
<i>Figure 5.27: Hip Cottage</i>	171	<i>Figure 6.14: Historic Door Styles - Bungalow / Craftsman</i>	215
<i>Figure 5.29: Modern Vernacular (Frame and Masonry)</i>	171	<i>Figure 6.15: Historic Door Styles - Mediterranean Revival / Spanish Colonial</i>	215
<i>Figure 5.30: Facade Conditions from Modern / Minimal Traditional Style</i>	172	<i>Figure 6.16: Historic Door Styles - Colonial Revival</i>	216
<i>Figure 5.31: Concrete Block with Rounded Edges</i>	173	<i>Figure 6.17: Anatomy of a Door</i>	217
<i>Figure 5.32: Facade Conditions from Modern / Hip Cottage Styles</i>	174	<i>Figure 6.18: Entry Door and Ornamental Trim</i>	218
<i>Figure 5.33: Facade Conditions from Modern / Ranch Styles</i>	176	<i>Figure 6.19: Historic Window Styles - Bungalow / Craftsman</i>	221
<i>Figure 5.34: Screen Block Wall</i>	179	<i>Figure 6.20: Historic Window Styles - Mediterranean Revival / Spanish Colonial</i>	221
<i>Figure 5.35: Facade Conditions from Tudor House Style</i>	180	<i>Figure 6.21: Historic Window Styles - Colonial Revival</i>	222
<i>Figure 5.36: Tudor Facade Features</i>	181	<i>Figure 6.22: Anatomy of a Window</i>	223
<i>Figure 5.37: Facade Conditions from Prairie House Style</i>	182	<i>Figure 6.23: Accessibility Ramp Next to Driveway</i>	239
<i>Figure 5.38: Facade Conditions from Dutch Colonial House Style</i>	183	<i>Figure 6.24: Appropriate Paint Colors for Historic Houses</i>	241
<i>Figure 6.1: Exterior House Features and Details</i>	186	<i>Figure 6.25: Relocation</i>	246
<i>Figure 6.2: Maintenance, Repair and Alterations to Existing Historic House</i>	187	<i>Figure 6.26: Demolition</i>	247
<i>Figure 6.3: Common Flat Roof Types</i>	190	<i>Figure 7.1: Conditions of House Features to be Assessed</i>	249
<i>Figure 6.4: Common Gable Roof Types</i>	191	<i>Figure 8.1: Common Air Leaks. Air infiltrates into and out of a home through every hole and crack. About one-third of this air infiltrates through openings in ceilings, walls, and floors</i>	277
<i>Figure 6.5: Common Hip Roof Types</i>	192	<i>Figure 8.2: Residential Building Energy Efficiency Diagram</i>	280
<i>Figure 6.6: Other Common Roof Types</i>	194	<i>Figure 8.3: Asbestos-Cement Siding Installation Specifications (McCawley, 1940).</i>	283
<i>Figure 6.7: Roof Materials</i>	195	<i>Figure 8.4: Partial Wall Section for Shingle Siding Construction; shows a drip cap and</i>	
<i>Figure 6.8: Fully Exposed Straight-Shaft and Stepped Masonry Chimneys</i>	199		
<i>Figure 6.9: Eaves and Overhangs</i>	201		
<i>Figure 6.10: Porches of Historic House Styles</i>	204		
<i>Figure 6.11: Common Porch Types on Historic Houses</i>	205		

apron in place to protect the bottom edge of siding shingles. **285**

Figure 8.5: *Asbestos-cement products most commonly deteriorate by cracking and chipping. These kinds of deterioration are not typically feasible to repair, and therefore it is recommended that a non-asbestos fiber cement piece be used as a replacement (photo by author).* **288**

Figure 8.6: *Replacement non-asbestos fiber-cement shingles in place, before being painted and after (photo by author).* **289**

INTRODUCTION

Lakeland has a rich architectural history spanning over a century. The City of Lakeland is proud of its historic buildings, which represent numerous architectural styles, eras of development, and the social and cultural history of its past and present citizens. This architectural heritage conveys Lakeland's identity through a diversity of building types and materials, development patterns, and cultural associations. Preserving these irreplaceable resources provides a vital connection to our collective history, and serves as a foundation for Lakeland's future.

Through historic designation and design review, historic buildings and properties are protected by ensuring they receive proper maintenance and that any alteration to them is done in a manner that is compatible with the architecture of the building and its surrounding environment. This *Design Guidelines for Historic Properties* document has been created to facilitate understanding of the design review process undertaken by the City of Lakeland's Historic Preservation Board. Through this process, a **Certificate of Review** may be issued for the alteration, relocation, demolition of an existing structure,

or new construction of a structure in a historic district, as well as the alteration, relocation, or demolition of an individually designated historic structure, prior to receiving a building permit.

Based upon the *Design Guidelines for Historic Properties*, the character and integrity of the City's historic districts and landmark buildings are maintained, as changes to existing buildings and proposed new construction are reviewed for consistency with the guidance provided in this document. This document is intended to be used by property owners, developers, design and real estate professionals, and other interested individuals in preserving Lakeland's historic resources. Historic preservation furthers the City's vision of being a vibrant, innovative, culturally inclusive, world-class community, as well as its mission as a community working together to achieve an exceptional quality of life. By guiding compatibly-designed, sustainable development and redevelopment through sound planning and community development principles, Lakeland's quality of life is enhanced.



1.1 PURPOSE OF THE DESIGN GUIDELINES

The aesthetic, cultural, environmental, and economic value historic preservation brings to Lakeland is important, and significantly contributes to our city’s unique character. Protecting historic buildings, sites, and neighborhoods by following these Design Guidelines for Historic Properties preserves and continues the story of Lakeland for current and future generations.

The Guidelines are intended to:

- Provide informative guidance on maintaining and protecting the character and architectural integrity of Lakeland’s historic buildings and districts.
- Provide clear direction on historic preservation and urban design principles for residents,

property owners, design professionals, and other potential applicants;

- Provide illustrations, graphics, and photographic examples to help demonstrate acceptable and not acceptable approaches;
- Provide more predictability and consistency in the administration, interpretation, and implementation of the design review process;
- Provide the basis for reasonable and fair decision-making by the City’s Historic Preservation Board and Design Review Committee;
- Provide a foundation for the development of district-specific guidelines to address issues and variations that are unique to Lakeland’s individual local historic districts.



William E. Browning House, c. 1910, formerly located on S. Tennessee Avenue.



Chatauqua Auditorium, c. 1920



Kentucky Avenue, date unknown



City Hall, 1918

Why Preserve Historic Buildings?

Historic preservation is a proven tool for the revitalization, sustainability, and economic development of communities across the country. There are several specific reasons for preserving our historic built environment:

- Preservation helps to tell the story of Lakeland’s diverse history by allowing for a tangible link to our many and varied stories. Historic building rehabilitation projects enhance Lakeland’s aesthetic quality and support urban design standards through redevelopment.
- Preservation builds strong neighborhoods by protecting historic and cultural character, providing a sense of place and belonging, and encouraging an appreciation of local history, and in turn, makes them desirable places to live.
- Preservation strengthens the local economy by stabilizing and increasing property values, creating jobs related to rehabilitation and the building trades, and promoting heritage tourism. Additionally, historic downtown settings often create niche markets that fuel local businesses.
- Preservation is sustainable and environmentally responsible; reusing and adapting old buildings for productive new uses reduces the consumption of land, new materials, and valuable resources. As architect Carl Elefante stated, “the greenest building is the one already built.”



Aerial Image of Downtown Lakeland, date unknown

The Guidelines are not intended as a substitute for consultation with qualified architects, contractors, attorneys, City staff, and/or the Historic Preservation Board or its Design Review Committee.

1.2 POLICY AND REGULATORY FRAMEWORK

The Guidelines supplement and are supported by other regulations adopted by the City of Lakeland, including the Land Development Code and the Secretary of the Interior’s Standards for the

Treatment of Historic Properties. The Guidelines apply to historic properties governed by separate sets of designation: local and National Register of Historic Places.

1.2.1 LAND DEVELOPMENT CODE

The City of Lakeland Land Development Code (“LDC”) regulates land use, zoning, building development, and subdivision development within the City of Lakeland. The provisions specific to historic preservation are in Article 11: Historic Preservation Standards. According to these provisions, the Historic Preservation Board is authorized to create Rules of Procedure relating to its various processes and procedures. Rules of Procedure were adopted in 2015 that further explain the Certificate of Review application and design review processes related to Major (Design Review Committee) Review and Minor (Staff) Review.

The LDC regulates what uses may be allowed on all properties in the City, including historic properties. Uses permitted by zoning are not affected by historic district or landmark designation. The historic designation allows for the regulation of the design and appearance of a property rather than its use.

1.2.2 SECRETARY OF THE INTERIOR’S STANDARDS FOR THE TREATMENT OF HISTORIC PROPERTIES

The Secretary of the Interior’s Standards for the Treatment of Historic Properties are nationally-accepted standards established by the U.S. Department of the Interior, and administered by the National Park Service. The Secretary of the Interior’s Standards for Rehabilitation are the most commonly applicable standards, and are the basis for these Guidelines. When reviewing a project for Certificate of Review consideration, the Historic Preservation Board’s Design Review Committee and staff use the appropriate Secretary’s Standards, in addition to the Guidelines and LDC, in making their decision. The Secretary’s Standards are reprinted below.



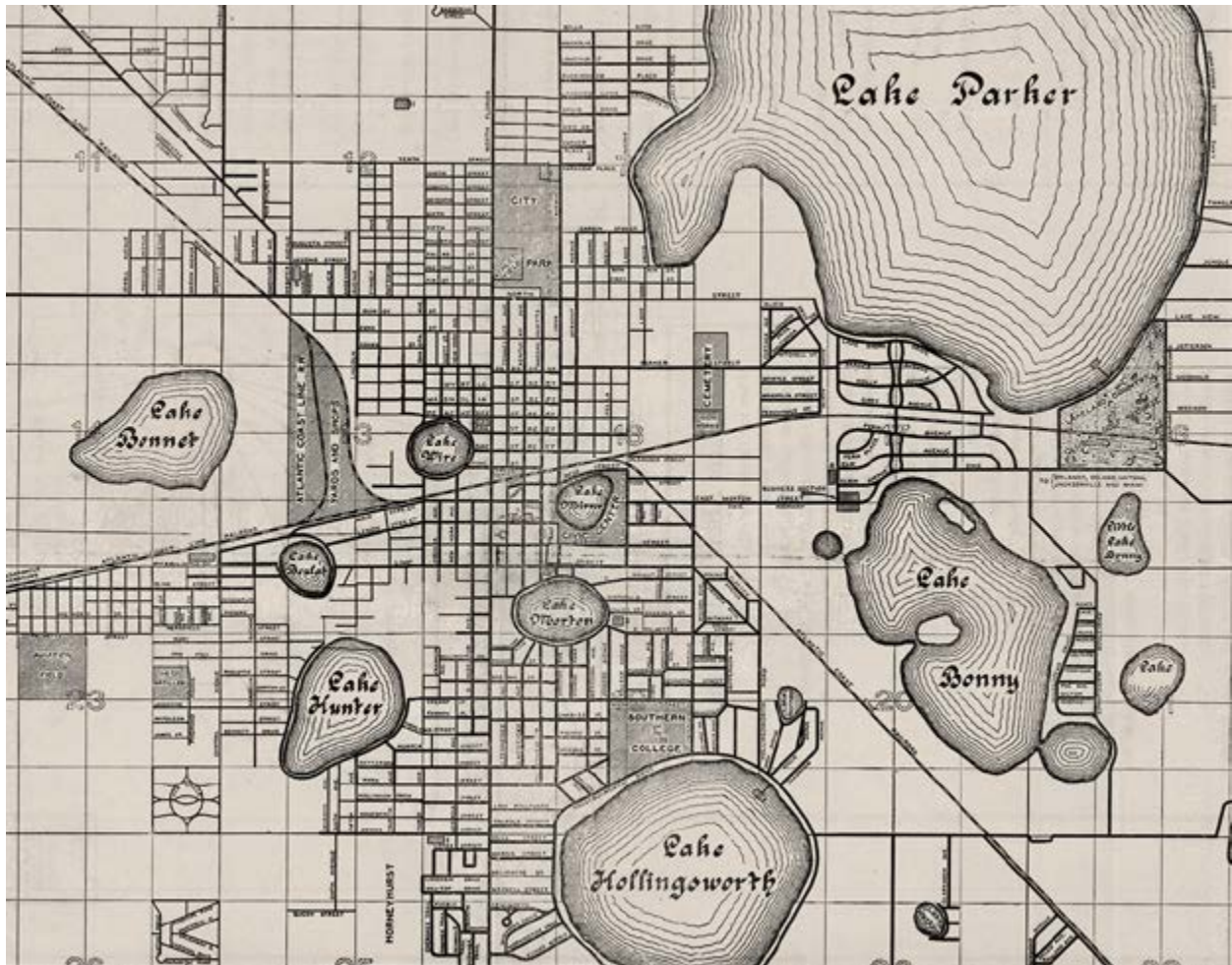

The History of the City of Lakeland Historic Preservation Program

On July 7, 1980, following a concerted effort of support from Historic Lakeland, Inc., City Commission adopted Ordinance #2203 that established a comprehensive historic preservation program for Lakeland, including the creation of the Historic Preservation Board and setting forth processes for designating historic districts and landmarks, as well as design review. Soon after, the Munn Park Historic District was established as the

City's first historic district. Today, the historic preservation ordinance has been fully incorporated into the Land Development Code as Article 11: Historic Preservation Standards.

Based on the merits of its historic preservation program, the City of Lakeland was designated a Certified Local Government by the National Park Service in 1989, which qualifies it for assistance from the Florida Division of Historical Resources, as well as eligibility for state historic preservation grants.

Standards for Preservation



Preservation:

Focuses on the maintenance and repair of existing historic materials and retention of a property's form as it has evolved over time.

1. A property will be used as it was historically, or be given a new use that maximizes the retention of distinctive materials, features, spaces, and spatial relationships.
2. Where a treatment and use have not been identified, a property will be protected and, if necessary, stabilized until additional work may be undertaken.
3. The historic character of a property will be retained and preserved. The replacement of intact or repairable historic materials or alteration of features, spaces, and spatial relationships that characterize a property will be avoided.
4. Each property will be recognized as a physical record of its time, place, and use. Work needed to stabilize, consolidate, and conserve existing historic materials and features will be physically and visually compatible, identifiable upon close inspection, and properly documented for future research.
5. Changes to a property that have acquired historic significance in their own right will be retained and preserved.
6. Distinctive materials, features, finishes, and construction techniques or examples of craftsmanship that characterize a property will be preserved.
7. The existing condition of historic features will be evaluated to determine the appropriate level of intervention needed. Where the severity of deterioration requires repair or limited replacement of a distinctive feature, the new material will match the old in composition, design, color, and texture.
8. Chemical or physical treatments, if appropriate, will be undertaken using the gentlest means possible. Treatments that cause damage to historic materials will not be used.
9. Archeological resources will be protected and preserved in place. If such resources must be disturbed, mitigation measures will be undertaken.



Rehabilitation:

Acknowledges the need to alter or add to a historic property to meet continuing or changing uses while retaining the property's historic character.

1. A property will be used as it was historically or be given a new use that requires minimal change to its distinctive materials, features, spaces, and spatial relationships.
2. The historic character of a property will be retained and preserved. The removal of distinctive materials or alteration of features, spaces, and spatial relationships that characterize a property will be avoided.
3. Each property will be recognized as a physical record of its time, place, and use. Changes that create a false sense of historical development, such as adding conjectural features or elements from other historic properties, will not be undertaken.
4. Changes to a property that have acquired historic significance in their own right will be retained and preserved.
5. Distinctive materials, features, finishes, and construction techniques or examples of craftsmanship that characterize a property will be preserved.
6. Deteriorated historic features will be repaired rather than replaced. Where the severity of deterioration requires replacement of a distinctive feature, the new feature will match the old in design, color, texture, and, where possible, materials. Replacement of missing features will be substantiated by documentary and physical evidence.
7. Chemical or physical treatments, if appropriate, will be undertaken using the gentlest means possible. Treatments that cause damage to historic materials will not be used.
8. Archaeological resources will be protected and preserved in place. If such resources must be disturbed, mitigation measures will be undertaken.
9. New additions, exterior alterations, or related new construction will not destroy historic materials, features, and spatial relationships that characterize the property. The new work will be differentiated from the old and will be compatible with the historic materials, features, size, scale, and proportion, and massing to protect the integrity of the property and its environment.
10. New additions and adjacent or related new construction will be undertaken in such a manner that, if removed in the future, the essential form and integrity of the historic property and its environment would be unimpaired.

Standards for Restoration



Restoration:

Depicts a property at a particular period of time in its history, while removing evidence of other periods.

1. A property will be used as it was historically or be given a new use which reflects the property's restoration period.
2. Materials and features from the restoration period will be retained and preserved. The removal of materials or alteration of features, spaces, and spatial relationships that characterize the period will not be undertaken.
3. Each property will be recognized as a physical record of its time, place, and use. Work needed to stabilize, consolidate, and conserve materials and features from the restoration period will be physically and visually compatible, identifiable upon close inspection, and properly documented for future research.
4. Materials, features, spaces, and finishes that characterize other historical periods will be documented prior to their alteration or removal.
5. Distinctive materials, features, finishes, and construction techniques or examples of craftsmanship that characterize the restoration period will be preserved.
6. Deteriorated features from the restoration period will be repaired rather than replaced. Where the severity of deterioration requires replacement of a distinctive feature, the new feature will match the old in design, color, texture, and, where possible, materials.
7. Replacement of missing features from the restoration period will be substantiated by documentary and physical evidence. A false sense of history will not be created by adding conjectural features, features from other properties, or by combining features that never existed together historically.
8. Chemical or physical treatments, if appropriate, will be undertaken using the gentlest means possible. Treatments that cause damage to historic materials will not be used.
9. Archaeological resources affected by a project will be protected and preserved in place. If such resources must be disturbed, mitigation measures will be undertaken.
10. Designs that were never executed historically will not be constructed.



Reconstruction:

Re-creates vanished or non-surviving portions of a property for interpretive purposes.

1. Reconstruction will be used to depict vanished or non-surviving portions of a property when documentary and physical evidence is available to permit accurate reconstruction with minimal conjecture, and such reconstruction is essential to the public understanding of the property.
2. Reconstruction of a landscape, building, structure, or object in its historic location will be preceded by a thorough archeological investigation to identify and evaluate those features and artifacts which are essential to an accurate reconstruction. If such resources must be disturbed, mitigation measures will be undertaken.
3. Reconstruction will include measures to preserve any remaining historic materials, features, and spatial relationships.
4. Reconstruction will be based on the accurate duplication of historic features and elements substantiated by documentary or physical evidence rather than on conjectural designs or the availability of different features from other historic properties. A reconstructed property will re-create the appearance of the non-surviving historic property in materials, design, color, and texture.
5. A reconstruction will be clearly identified as a contemporary re-creation.
6. Designs that were never executed historically will not be constructed.

1.2.3 HISTORIC DESIGNATION: LOCAL VERSUS NATIONAL REGISTER OF HISTORIC PLACES

All of Lakeland’s historic districts and many of its individual landmark buildings have been designated locally by City ordinance, as well as listed on the National Register of Historic Places. Both locally designated historic resources and those listed on the National Register of Historic Places are subject to design review by the Historic Preservation Board’s Design Review Committee, per [the Historic Preservation Standards](#) (LDC, Article 11, Sub-Section 11.6.2.c).

In general, local designation protects designated districts and buildings by requiring that changes to these properties receive design review to determine whether the change is compatible with the building and its surrounding neighborhood and consistent with locally adopted design guidelines and standards. Listing on the National Register of Historic Places is honorific and does not protect a building from insensitive changes or demolition typically. If

state or federal funding is used to alter a building or property listed on the National Register, then a review process known as a Section 106 Assessment must be undertaken to determine a project’s effects to a historic resource. This is usually not the case for a typical project undertaken by a homeowner, however.

Within the State of Florida, Department of State, the Florida Division of Historical Resources (the State Historic Preservation Office or “SHPO”) maintains an inventory of historic resources known as the Florida Master Site File (“FMSF”). The FMSF is not a register of designated historic properties and does not provide any form of protection for these properties; it is simply a method of identifying resources that may or may not be eligible for local designation or listing on the National Register of Historic Places.



1.3 USING THE GUIDELINES

The Guidelines establish guidance and recommended practices for historic preservation and design. Those applying for design review are encouraged to review the Guidelines before beginning their project to facilitate an efficient review process. In addition to compliance with the [City of Lakeland Land Development Code](#) (“LDC”), applicants must obtain a **Certificate of Review** (“COR”) from the Historic Preservation Board or its staff for all proposed changes to designated historic buildings and buildings within historic districts, as described in this section.

Overall, the Guidelines are intended to work in agreement with the LDC and other City regulations governing land use and development. In the event a conflict between regulations or the LDC and these Guidelines, the Guidelines shall control. The meaning of all words, terms, or phrases in the Guidelines shall be construed in accordance with the definitions provided in Sub-Sections 1.6 and 11.2 Definitions of the LDC. In the case of a conflict regarding a definition as provided in these Guidelines and Sub-Section 1.6 of the LDC, the Guidelines definition shall control.



1.3.1 APPLICABILITY

The Guidelines apply to all **exterior** alterations or modifications to:

- Landmark buildings individually designated by City ordinance and/or listed on the National Register of Historic Places;
- All buildings and properties located within a designated historic district.

The Guidelines also apply to the construction of new buildings and structures within designated historic districts or on property containing an individually designated landmark building or structure.

The Guidelines, which contains numerous pictures, illustrations, drawings, and examples of projects that have successfully met, or failed to meet, the recommendations that the guidelines address. Examples are provided only to illustrate and show context; they should not be construed as the only possible design solutions allowed.



EXTENT OF DESIGN GUIDELINES

HISTORIC DISTRICTS

- Munn Park*
- Beacon Hill*
- Biltmore-Cumberland*
- Dixieland*
- Lake Hunter Terrace*
- South Lake Morton*
- East Lake Morton*

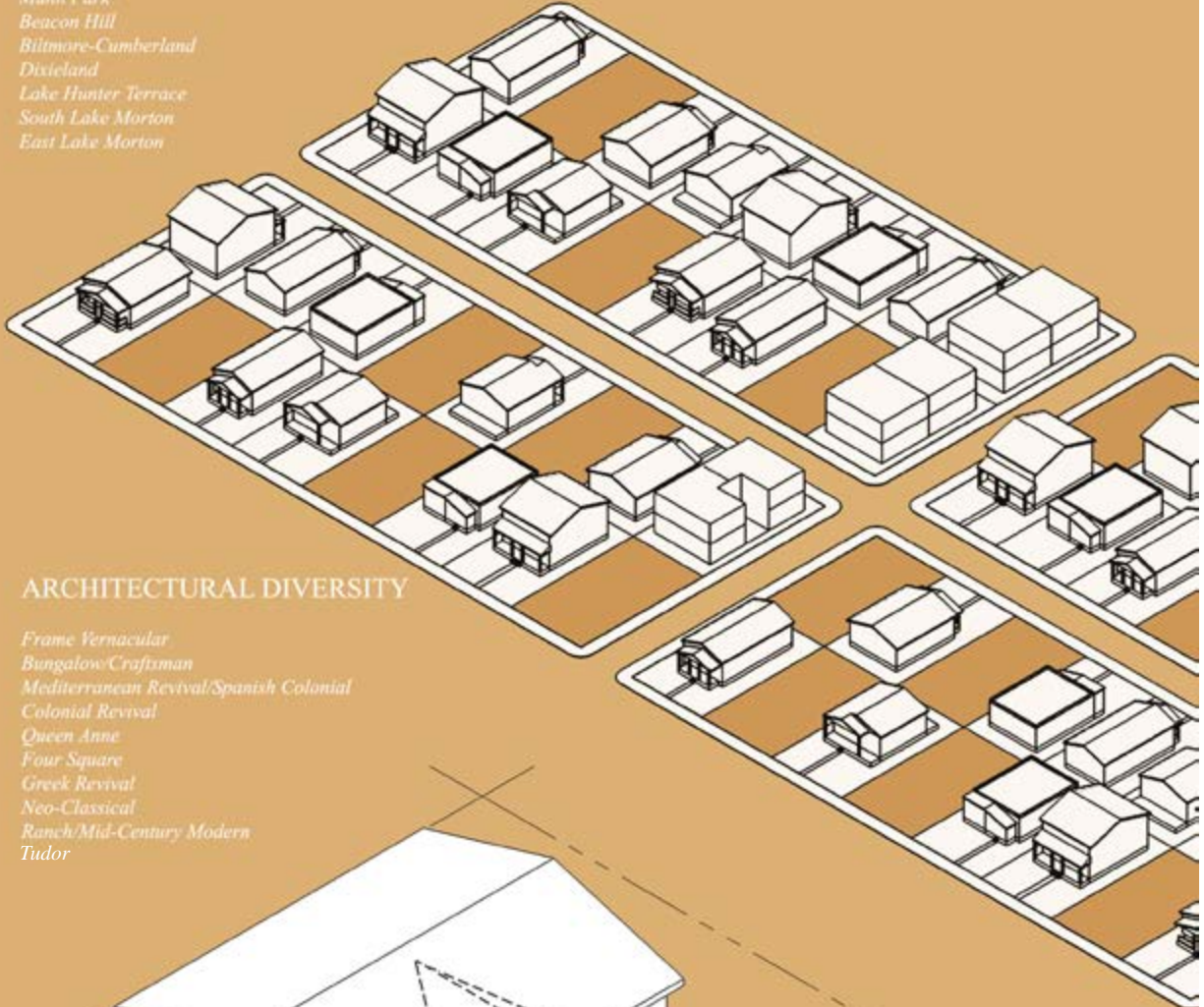

ARCHITECTURAL DIVERSITY

- Frame Vernacular*
- Bungalow/Craftsman*
- Mediterranean Revival/Spanish Colonial*
- Colonial Revival*
- Queen Anne*
- Four Square*
- Greek Revival*
- Neo-Classical*
- Ranch/Mid-Century Modern*
- Tudor*

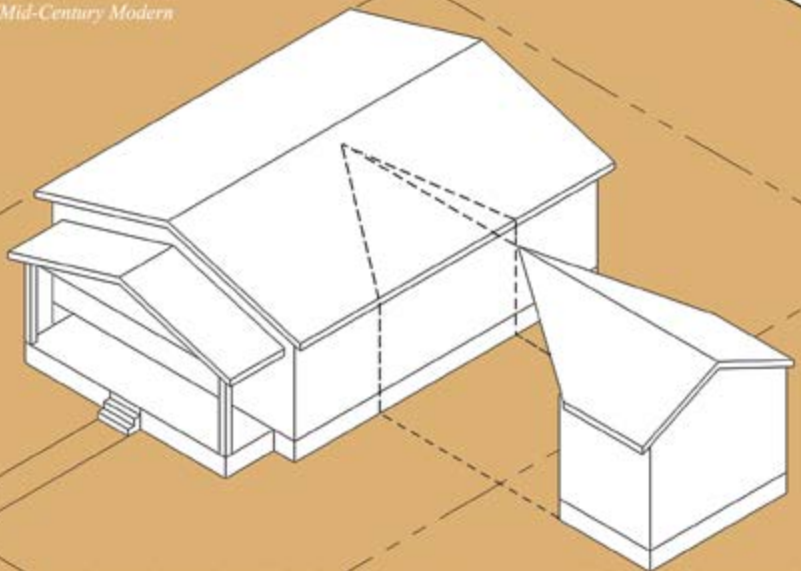

DETAILS

- Door and Windows*
- Front Yard Features*
- Porches*
- Street-Facing Facade*

Figure 1.1: Extent of Design Guidelines

1.3.2 PROPERTY CLASSIFICATIONS (CONTRIBUTING AND NON-CONTRIBUTING)

All buildings within historic districts were classified as either Contributing or Non-Contributing to their respective district at the time the district was surveyed or re-surveyed.

Contributing Building:

Generally, a contributing building is determined to be historically significant and contributes to the character of the historic district. It was present during the period of significance of the district, and possesses enough integrity to convey its history, or is capable of yielding important information about that period. While alterations to the original design may exist, the major character-defining features remain, and the building retains much of its original fabric. Other contributing properties may not have been built during the period of significance of the

district, but may have gained historic significance in their own right, or are associated with important people or events.

Non-Contributing Building:

Generally, a non-contributing building is determined to not be historically significant and its removal would not negatively impact the historic district. A historic structure may be determined to be non-contributing because major character-defining features have been altered so significantly that the original and/or historic form, materials, and details are indistinguishable, and alterations are irreversible. Non-Contributing Buildings are often afforded more flexibility from the Guidelines.





Example: Traditional Four Square Facade

TRADITIONAL FACADE
 “Contributing” Property: This building retains integrity.



Example: Slightly Altered Four Square Facade

ALTERED TRADITIONAL FACADE
 “Contributing” Property with some alterations: This building retains integrity.



Example: Majorly Altered Four Square Facade

SUBSTANTIALLY ALTERED, NO HISTORIC FEATURES
 “Non-Contributing” Property with major alterations: This building does not retain its integrity.

Figure 1.2: Preserving Architectural Integrity

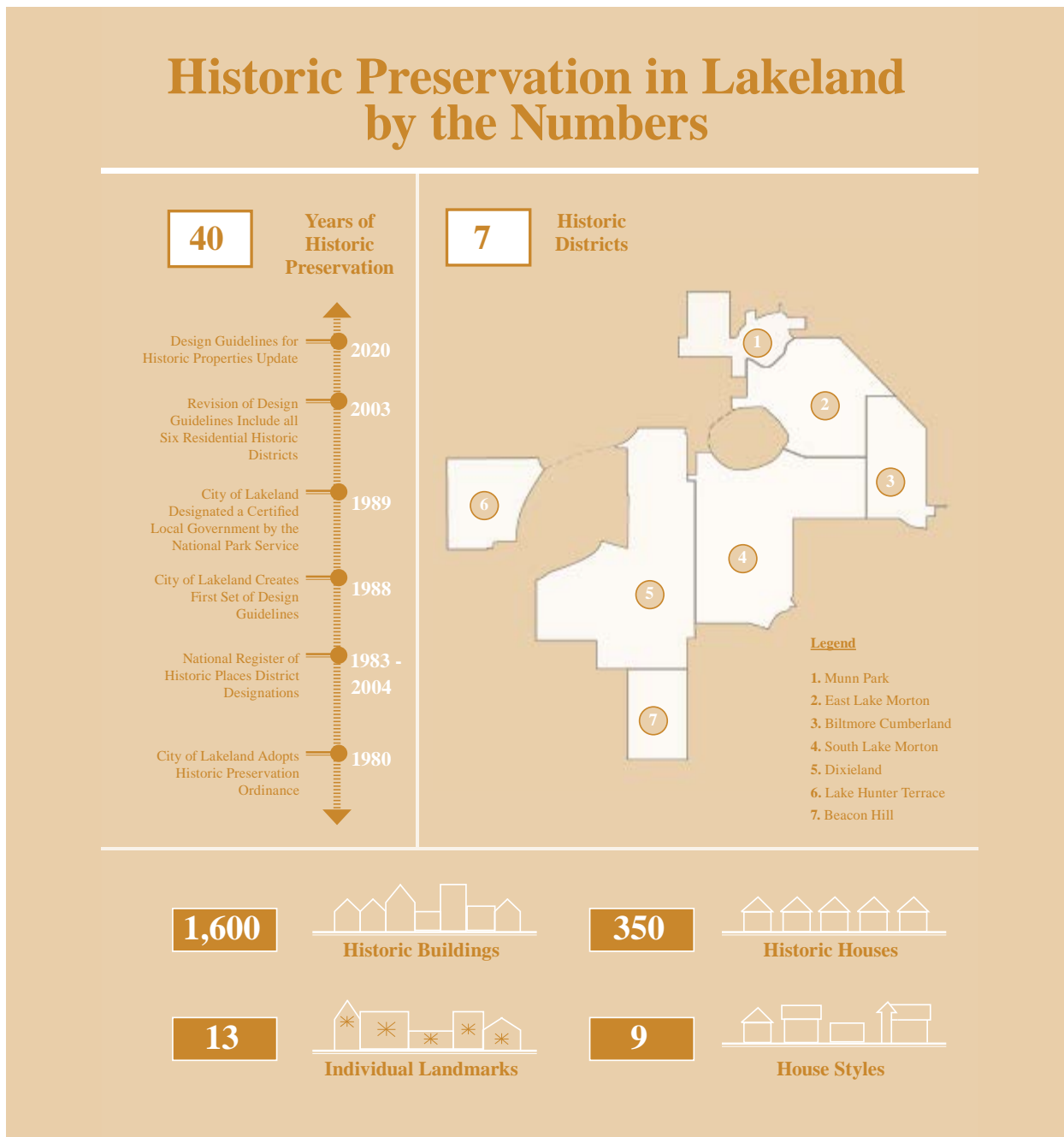

Figure 1.3: Info-Graphic / Historic Preservation in Lakeland by the Numbers

This info-graphic describes the forty-year time-frame of historic preservation actions and activities in the City of Lakeland. With the adoption of the City’s Historic Preservation Ordinance in 1980, followed by several historic district designations, certification as a Local Government by the National Park

Service and the update to this document, indicates the commitment the City has made to preserve its architectural heritage. The seven historic districts contain over one thousand-six hundred Contributing historic buildings (thirteen of which have Landmark status) and nine distinct architectural styles.

1.4 HOW TO USE THIS DOCUMENT

These Design Guidelines are intended as a reference manual for protecting and preserving historic buildings, implementing best industry practices for maintaining and caring for historic structures, to insure the long-term sustainability of historic properties and maintaining the integrity of the City’s seven historic districts. These Guidelines also address other relevant issues such as, historic district contextual conditions, the identification of architectural styles, infill development and building additions, as well as the familiarity with the details of individual structures.

To provide property owners, architects, builders and the general public with a comprehensive understanding of the City’s preservation standards, this document is organized in eight sections:

- Introduction
- Design Review Process
- Historic Districts
- Neighborhood Blocks, Streets and Lots
- Houses Styles

- Exterior Architectural Features: Alteration and Maintenance
- Project Planning
- Appendix

This organizational structure is further intended to allow for easier navigation, greater usability, and consideration of preservation issues at multiple scales. The Guidelines Usage Matrix below is a quick reference guide for various types of work related to historic structures. Based on the type of work activity planned for one of these structures, this matrix can help home owners, builders, architects and others access the information in these Guidelines that will facilitate the preservation of historic structures and the use of best industry practices for maintaining and repairing them. This matrix cross references a number of typical work activities with the different sections of this document to provide a broader understanding of all of the guidelines and recommendations associated with major and minor work.



Guidelines Usage Matrix

Use the chart below to determine which sections of these guidelines you should use in planning your project.

TYPE OF WORK		SECTION 1	SECTION 2	SECTION 3	SECTION 4	SECTION 5	SECTION 6	SECTION 7	SECTION 8
		Introduction	Design Review Process	Historic Districts	Neighborhood Blocks, Streets and Lots	House Styles	Exterior Architectural Features: Alteration and Maintenance	Project Planning	Appendix
MINOR REVIEW	Maintenance and Repair	✓	✓	✓		✓	✓		✓
	Reroofing	✓	✓	✓		✓	✓		
	Replacement of Existing Features	✓	✓	✓		✓	✓		
	Accessory Structures	✓	✓	✓	✓				
	Decks	✓	✓	✓		✓	✓		
	Fences and Walls	✓	✓	✓	✓				✓
	Driveways, Walkways and Paving	✓	✓	✓	✓				
	Signs	✓	✓	✓			✓		
MAJOR REVIEW	Rehabilitation/ Restoration of Existing Building	✓	✓	✓	✓	✓	✓	✓	
	Exterior Alteration to an Existing Building Beyond the Scope of Minor Review Project	✓	✓	✓	✓	✓	✓	✓	
	Addition to an Existing Building	✓	✓	✓	✓	✓	✓	✓	
	Construction of a New Building	✓	✓	✓	✓			✓	
	Construction of Accessory Building Larger than 300 Sq. Ft.	✓	✓	✓	✓			✓	
	Demolition of an Existing Building	✓	✓	✓				✓	

2



DESIGN REVIEW PROCESS

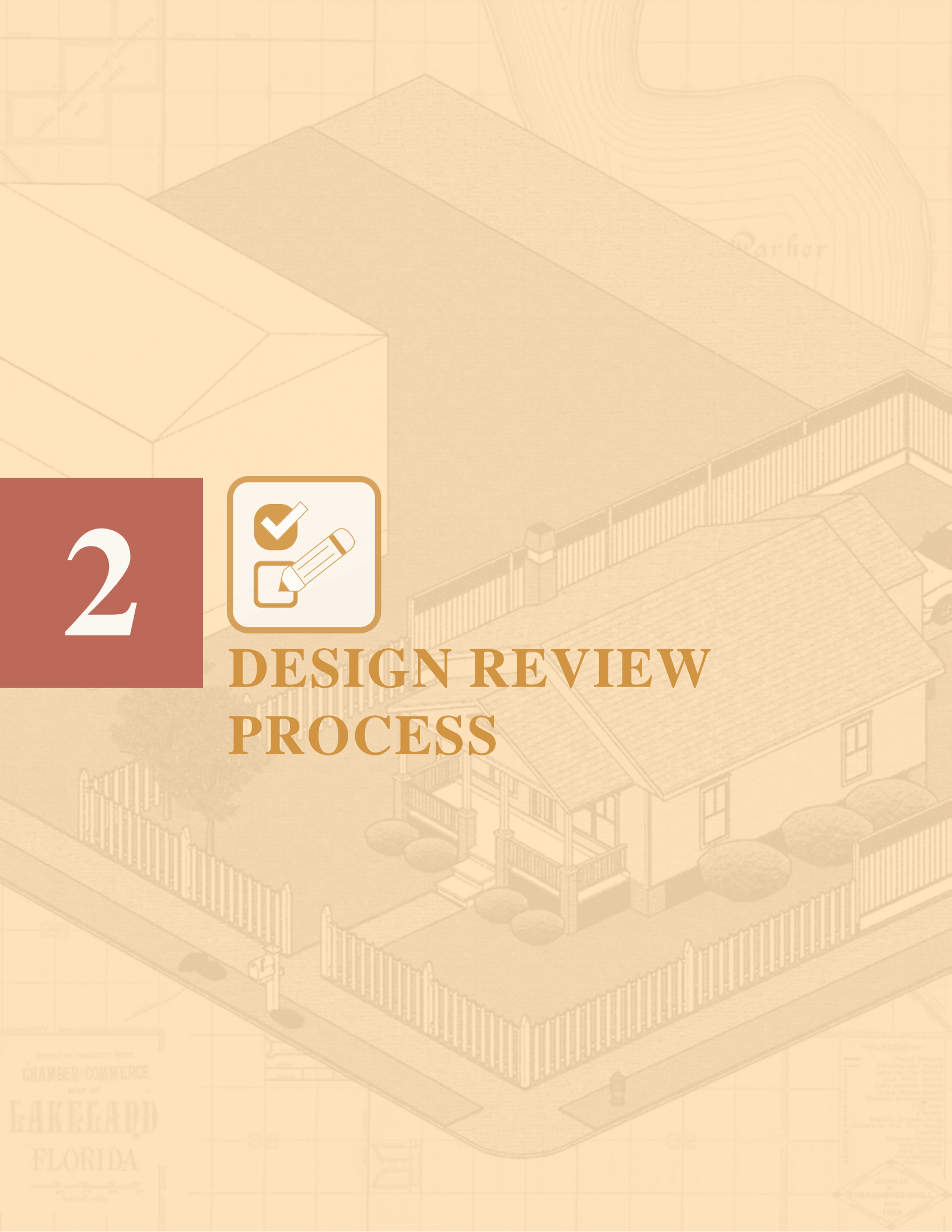

2.1 DESIGN REVIEW AND CERTIFICATE OF REVIEW PROCESS

The City of Lakeland is proud of its diverse architectural and historic neighborhoods. To preserve these cultural assets and protect the historic architectural integrity and character of each structure and historic district, all modifications, alterations and additions to these buildings, as well as new construction is subject to the City's design review process. Depending on the extent of the proposed changes, this process may require a Certificate of Review (COR).

A Certificate of Review is required prior to other entitlements, such as zoning compliance, building permits, certificates of occupancy, etc. This process has been streamlined to accommodate minor, moderate and major work related to both Contributing or Non-Contributing buildings in each of the seven historic districts as well as individual landmarks. The Design Review Process is comprised of a series of steps that clearly identifies what is required of the application relative to the type of work being initiated.



2.2 UNDERSTANDING THE DESIGN REVIEW PROCESS

All properties located in the City’s historic districts or designated as an individual local historic landmark are subject to the Design Review process, according to the City of Lakeland’s Land Development Code (“LDC”). This means that any material change or alteration to the **exterior** of a designated historic building or building/property in the historic districts must be reviewed and approved by the Historic Preservation Board’s (HPB) Design Review Committee (“DRC”) or its staff prior to the issuance of permits and start of such a project. The Design Review process works in conjunction with other City development processes, such as zoning compliance and building permit issuance. It is the applicant’s responsibility to ensure that his or her project complies with all City requirements.

Alterations to the **interior** of buildings not affecting the exterior building fabric do not require Design Review, but may still require a permit from the Building Inspection Division.

Certificate of Review

Approved projects will receive a Certificate of Review (“COR”) as the official written record of design review approval. A COR is necessary before permits can be issued by the Building Inspection Division or other City departments. To receive a COR for a proposed project, it is necessary to submit an Application for Design Review to initiate the Design Review process. This is done in the City of Lakeland’s [iMS System](#).

Explained in further detail in this section, there are two types of Design Review applications: **Minor Review** by HPB staff, for relatively small-scale and straightforward projects; and **Major Review** by the DRC, for large-scale or complex projects. Decisions for both types of reviews are guided by the Secretary of the Interior’s Standards for Rehabilitation, these Guidelines, and the LDC.

DESIGN REVIEWERS

City of Lakeland Senior Planner, Historic Preservation

As primary staff for the HPB, the Senior Planner, Historic Preservation, administers all aspects of the historic preservation program, including reviewing and deciding upon Minor Review CORs.

Historic Preservation Board

The HPB consists of eleven members who reside in the City of Lakeland and are appointed by the City Commission. The responsibilities and duties of the HPB include identifying and recommending local historic districts and local historic landmarks for designation; maintaining a register of local historic places; appointing a Design Review Committee; and furthering public awareness of Lakeland’s history and historic preservation in general. The HPB also hears appeals from decisions regarding CORs from the DRC.

Design Review Committee

The DRC is a standing committee of the HPB that reviews and approves or denies CORs with respect to proposed exterior alterations to historic landmarks and properties within historic districts.

Florida’s Tenth Judicial Circuit Court

This Court hears appeals from decisions of the HPB.

Design Review Process



HISTORIC PRESERVATION DESIGN REVIEW PROCESS FLOW CHART

The chart below identifies the steps involved in submitting, reviewing, and approving an Application for Design Review and receiving a Certificate of Review (COR). The chart intended to assist applicants in preparing application materials at the appropriate level of detail to fit the project schedule. HPB staff will issue a COR for a successful design review application. A COR is necessary as part of the zoning review application. A COR is necessary as part of the zoning review and/or building permit process.

**Applications are due by a set deadline each month. Consult the [City of Lakeland](#) website for current dates.*

*** If the Board approves a project with conditions, the final construction drawings and building permit submittal must reflect those conditions.*

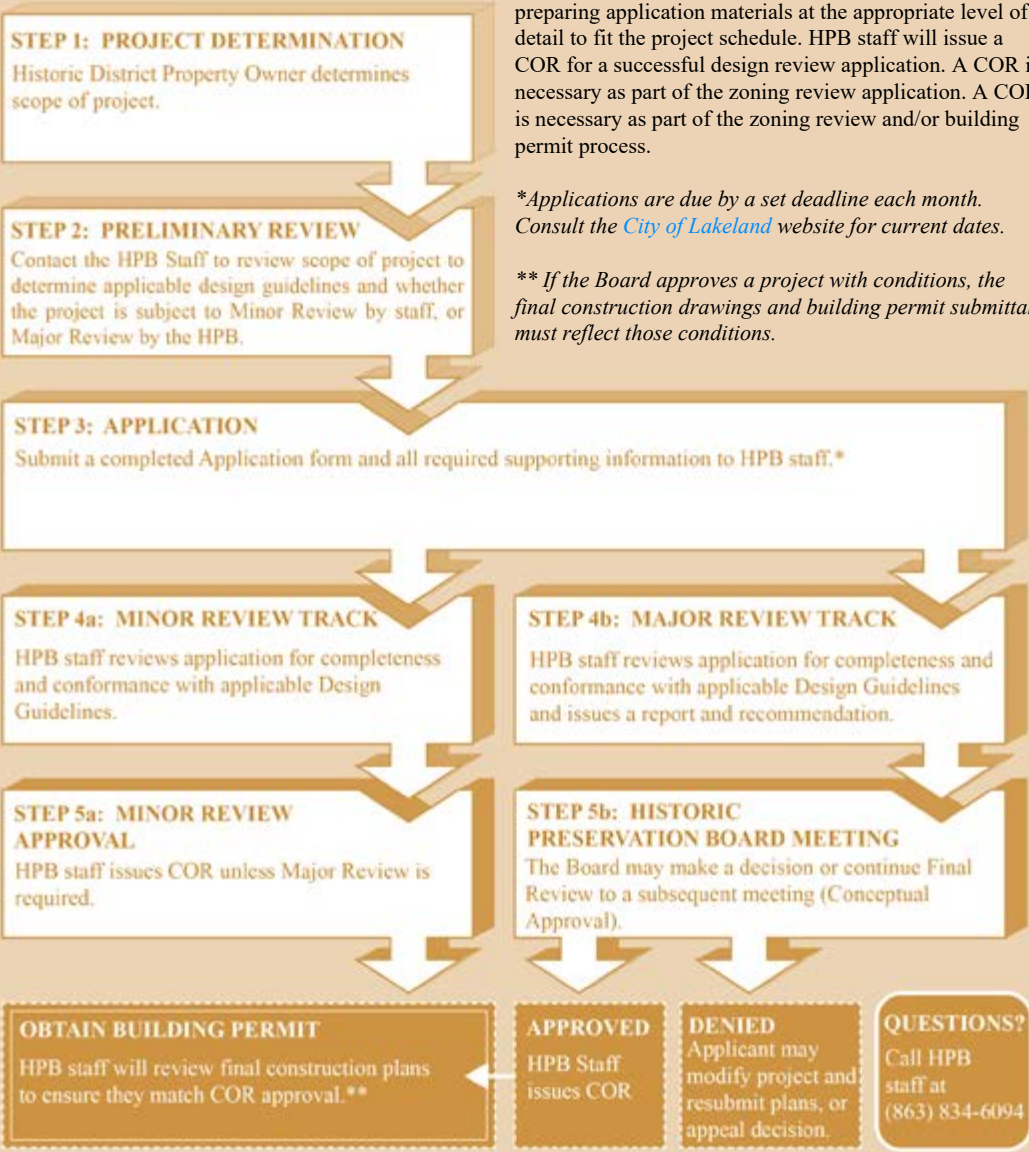

Figure 2.1: Design Review Process

2.2.1 PRELIMINARY REVIEW

Initial consultation with HPB staff for preliminary review of proposed projects prior to Design Review application submittal is encouraged, so that the specific requirements for a project can be discussed and application submission requirements can be verified with the applicant. Preliminary review is an informal meeting with HPB staff, and can be done in person, over the telephone, or via email. Each project is reviewed on a case-by-case basis, using these Guidelines and the Secretary's Standards as the basis for approval of projects. To schedule Preliminary Review for a proposed project, contact HPB Staff at historicpreservation@lakelandgov.net.

2.2.2 MINOR REVIEW

Minor Review is an administrative review performed by HPB staff for small-scale projects. Minor Review applications do not require review and approval by the DRC and can typically be processed and completed the same day the application is received, but in all cases, take no longer than three business days to complete. Provided all other City requirements are satisfied, a building permit can be obtained at the Building Inspection Division immediately after a Minor Review Design Review application is approved.

Minor Review applies to the following projects, which must be consistent with these Guidelines:

- **Maintenance and Repairs.** Any work to sustain the existing form or to correct deterioration, decay, or damage, provided that such work does not involve a change in design, material, or exterior appearance.
- **Reroofing.** The removal and replacement of roofing materials, provided that no other

significant alterations are made, i.e. change to roof pitch or shape, or removal of architectural roof features, dormers, and chimneys. Proposed replacement materials must be similar to existing materials. 5V crimp and standing seam metal roofing can replace shingle roofing for certain architectural styles.

- **Replacement of Existing Features.** The replacement of any original feature of a contributing resource is discouraged, unless the feature is deteriorated beyond repair. In such cases of severe deterioration, replacement of the feature with in-kind or similar materials is permitted. Features eligible for staff review and approval include: windows, doors, roofing, soffits, fascia, awnings, porch steps, railings, screening, or enclosures, and architectural ornamentation.
- **Accessory Structures.** The construction, relocation, removal, or demolition of accessory buildings provided that the structure is 300 square feet or less. Pools and pool screened enclosures regardless of size are eligible for administrative review.
- **Decks.** The construction or removal of decks not visible from a public right-of-way, other than an alley, provided that the decks do not incur any major alterations to a contributing building.
- **Fences and Walls.** The construction, replacement, or removal of any fences, walls, knee or street walls on a property.
- **Driveways, Walkways, Paving.** The construction or replacement of any permanent paving on a property.
- **Signs.** The installation of new signs and removal or alteration of historic signs.
- **Mechanical Systems.** The placement of mechanical systems and any screening material necessary to shield the mechanical systems from the street view shed.

- **Paint Colors.** Review is limited to the selection of paint colors for new residential buildings and all commercial buildings. The painting of unpainted brick or masonry is **prohibited**.
- Demolition of accessory structures.
- Any other request determined by HPB staff or designee of the HPB to have a minor impact or no potential detriment on the historic building or district.

Submission Requirements for Minor Review:

Complete an application for Historic Preservation Design Review – Minor in the [City's iMS system](#), under the Planning Projects tile. Once the Historic Preservation Design Review – Minor application is submitted and all required supporting documentation is uploaded, staff will review this project request for consistency with the Design Guidelines for Historic Properties and issue a Certificate of Review if appropriate for approval.

Replacements to Existing Features:

- Design specifications and a written description of replacement features.
- Photographs of existing building showing features to be replaced.
- A plot plan may be needed for multiple window/door replacements.

Contributing Building: Accessory Building/ Deck

Site plan showing existing house and location of proposed accessory building/deck, along with setback dimensions from property line

- Architectural elevations for proposed accessory building.
- Design specifications of accessory building/

deck, as necessary.

- Photographs of existing house and site.

Fences, Walls

- Site plan showing the existing house and location of the proposed fence/wall, as well as setback dimensions from property line.
- Design specifications of fence/wall, as necessary.

Driveways, Walkways, Paving:

- Site plan showing existing house and location of new paving.
- Design specifications of paving, as necessary

Architectural Ornamentation:

- Description of proposed ornament/detail/feature and reason it is being requested.
- Design specifications and material of architectural ornament.
- Photograph(s) of the existing building and area to which ornament is to be applied.

Signs:

- Description of sign type, dimensions (height, width, depth), and illumination method, if applicable.
- Rendering of sign.

Mechanical Systems (should NOT be visible from street):

- Image or Photograph of equipment.
- Site plan or description indicating where equipment will be located on building or site.

Paint Color (Munn Park/Commercial Buildings only):

- Proposed paint colors for body, trim, and accent.

- Do not paint unpainted brick or masonry.

If staff should disapprove a Minor Review application, the applicant may submit the request to the DRC for Major Review approval, and would then need to follow all submission requirements for the Major Review application process. All projects not eligible for Minor Review require Major Review.

2.2.3 MAJOR REVIEW

Major Review consists of formal design review performed by the DRC during their regularly scheduled public meeting held once per month. The DRC is specifically tasked with reviewing proposed large-scale or complex projects for consistency with these Guidelines and the Secretary’s Standards, as well as with the built environment surrounding the project. Major Review applies to the following projects:

- Major Rehabilitation/Restoration of an existing building.
- Exterior alterations to a building that are beyond the scope of eligible Minor Review projects.
- Addition to an existing building.
- Construction of a new principal building.
- Construction of an accessory building larger than 300 square feet.
- Relocation of an existing building.
- Demolition of an existing building.

Conceptual Approval:

Within the Major Review process, an applicant may request Conceptual Approval for any project. Under Conceptual Approval, the DRC can evaluate a project in which the details are not yet complete, provide advice to the applicant regarding revisions to or suggestions for the project, and grant Conceptual Approval of a project. If Conceptual Approval is granted, a second DRC meeting is necessary for a

project to be reviewed and receive Final Approval.

Submission Requirements for Major Review:

Complete an application for Historic Preservation Design Review – Major in the [City’s iMS system](#), under the Planning Projects tile. Once the Historic Preservation Design Review – Major application is submitted in iMS, including uploading all required supporting documentation, the application will be scheduled for the next available Design Review Committee meeting.

- Supporting Documents for each Project Subtype:

New Construction and Building Additions:

- Include a narrative describing design specifications such as the square footage of a new building or addition, number of stories, and list of all exterior building materials, such as roofing, siding, windows, doors, soffit/fascia, porch columns/railing, etc.
- Site plan of property showing footprint of new building or addition with setback dimensions to property lines.
- Architectural elevation drawings for all sides of new building or addition. Indicate building dimensions, including height and roof pitch on drawings.
- Floor plan for New Construction or Building Addition.
- Photographs showing the existing condition of property and adjacent properties.

Major Rehabilitation or Restoration:

- Include a narrative describing design specifications for the rehabilitation/restoration and a list of all new exterior building materials to be

used, such as roofing, siding, windows, doors, soffit/fascia, porch columns/railing, etc.

- Architectural elevation drawings for all sides of existing building affected by the project.
- Photographs of all sides of the existing building.
- Documentation substantiating historic appearance (for restoration work only).

Minor Exterior Alterations:

- Include a narrative describing design specifications for the alteration and a list of all new exterior building materials to be used, such as roofing, siding, windows, doors, soffit/fascia, porch columns/railing, etc.
- Photographs of all sides of existing building the alteration will affect and any adjacent buildings.

Accessory Buildings (over 300 SF):

- Include a narrative describing design specifications for the accessory building including square footage and a list of all exterior building materials, such as roofing, siding, windows, doors, soffit/fascia, porch columns/railing, etc.
- Site plan of property showing footprint of accessory building with setback dimensions to property lines.
- Architectural elevation drawings for all sides of accessory building. Indicate building dimensions, including height and roof pitch, on drawings.
- Floor Plan for the accessory building
- Photographs showing the existing condition of subject property

Relocation:

- Narrative explaining why relocation is necessary and the estimated timeframe

- Site Plan for the relocation of building on new property.

- Photographs of all sides of building and property.

Demolition:

- Provide a statement addressing each of the three demolition review criteria: Demolition is generally discouraged and shall be reviewed with regards to:
 - The architectural significance of the building or structure. Architectural significance shall be determined by the DRC at the time of the demolition request and shall be based upon documentation of the property's architectural integrity and historical or cultural significance. Designation of the building or structure as "non-contributing" by the most recent historic district survey does not preclude the DRC from making a determination of architectural significance.
 - The contribution of the building or structure to the history or origins of the historic district.
 - The future utilization of the site, including any replacement buildings or structures.
- Provide a statement addressing options for relocation and/or building materials salvage, estimate of demolition cost, and timeframe for demolition including redevelopment of property.
- Engineer's Report substantiating structural condition, including estimated cost to repair.
- Photographs of all sides of building and property.

How Does the Major Review Process Work?

Once a completed Major Review application is submitted to HPB staff (Community & Economic Development Department, Planning Division) the following process begins:

- HPB staff reviews the application within approximately three days after the application deadline date to determine completeness of the application.
- If staff decides to recommend anything other than approval as submitted, staff will collaborate with the applicant to decide whether the application will be revised, continued, or withdrawn. Staff has the authority to withhold from DRC consideration any request that appears to be in conflict with the City's LDC or other development regulations, that appears to contain factual misrepresentations, errors, or omissions, or for which there appears to be insufficient information to make an informed decision.
- If an application is rejected or withdrawn, it becomes inactive until it is resubmitted in an acceptable form.
- The applicant or a representative, such as the property owner or project design professional, must attend the DRC meeting for which the application is scheduled. Failure to attend the DRC meeting may delay review or approval of a project. The DRC may decide approval, approval with conditions, denial, or continue the application to a second meeting.
- If the request is denied, the applicant may submit revised plans that address the reasons for denial or appeal to the HPB within 30 days after the receipt of the Board Action.
- If the request is approved, the applicant will receive the Certificate of Review as a PDF document e-mailed to the applicant. If needed immediately, a copy can be obtained at the Property

Information counter (City Hall, 1N) during regular office hours, 8:00 a.m. – 5:00 p.m. Provided all other City code requirements and regulations relating to the project are satisfied, building permits for projects that do not require Concept or Site Plan Review may be obtained through the Building Inspection Division immediately after receiving the COR.

- For projects that require Concept or Site Plan Review with the City's Development Review Team, permits may be obtained after plan approval.

What to Expect at the DRC Public Meeting?

The purpose of the public meeting is to present the Applicant's request and facts concerning the project, provide the applicant with an opportunity to give testimony about the project to the DRC, and to obtain feedback from any affected property owners adjacent to the project. The DRC will then evaluate the request and make a decision. DRC decisions are based on the Secretary's Standards, these Guidelines, as well as a staff report and recommendation. If a request is approved, a Certificate of Review is issued to the applicant.

The HPB meets at 8:30 a.m. on the fourth Thursday of the month January through October and the third Thursday of the month in November and December. The HPB's agenda usually includes general business of the Board. Following adjournment of the HPB meeting, the DRC convenes and hears Design Review application requests. All applications presented at the DRC meeting are properly noticed to the public. All HPB and DRC meetings are open to the public; typically, only the DRC meeting is considered to be a public hearing, as testimony from the public concerning the Major Review cases is accepted.

2.3 DESIGN REVIEW PROCESS-FREQUENTLY ASKED QUESTIONS

I'm only planning to make minor improvements; do I still need to go through the HPB Design Review process?

No, minor projects can usually be approved by HPB staff with a Minor Review application.

How do I make sure that my project will be approved by the DRC?

Talk to staff early on. Provide all required documentation as listed in the Design Review application.

Do I need to hire an outside professional to get the DRC's approval?

Not necessarily, it generally depends on the scope of work. As long as sufficient documentation can be provided you may not have to hire a professional designer for Major or Minor Review.

I am planning a complex project. When is the best time to consult with HPB staff?

As soon as possible. Staff is available to discuss proposed projects even if you only have an idea or concept.

How long does the Major Review process typically take?

Generally, about 30 days if not seeking Conceptual Approval. If seeking Conceptual Approval, the review process takes approximately 60 days. Design Review applications are due approximately three weeks before the desired DRC meeting date. CORs are issued within 5 days of the meeting date (often sooner).

Is there a way to expedite the design review process?

Contact HPB staff for preliminary review before submitting your Design Review application. Submit a complete application with all required supporting documentation.

What information do I need to submit with my Design Review application?

See page 24 for "Submission Requirements for Minor Review" and page 25 for "Submission Requirements for Major Review."

Can I begin construction immediately after I get the DRC's or staff's approval?

Construction can begin once proper permits are issued, along with the required COR.

How are the Historic Design Guidelines enforced?

Planning and Building Inspections staff inspect work against issued CORs. Any work initiated without a COR will be subject to a Stop Work Order and potentially a daily fine, in addition to a doubled application fee.

Are there any financial incentives available for historic preservation?

There is a Federal Rehabilitation Tax Incentive for income producing properties listed on the National Register of Historic Places, or as a contributing building in a historic district listed on the National Register. See <https://www.nps.gov/tps/tax-incentives.htm>

Who can I contact with questions?

Contact HPB staff at historicpreservation@lakelandgov.net

HISTORIC DISTRICTS AND OTHER HISTORIC PROPERTIES

The City of Lakeland has seven areas that have local historic district designations, all of which are listed on the National Register of Historic Places. They include six residential neighborhoods that are located in close proximity to each other near the center of the city and one commercial area in Downtown. Local historic district designations for these areas date back to 1980 and paved the way

for subsequent neighborhood designations through 2004. Listing these areas on the National Register of Historic Places paralleled the local designations from 1993 to 2004. These areas and other individual historic structures scattered around the city represent Lakeland’s rich architectural heritage during its formative years.

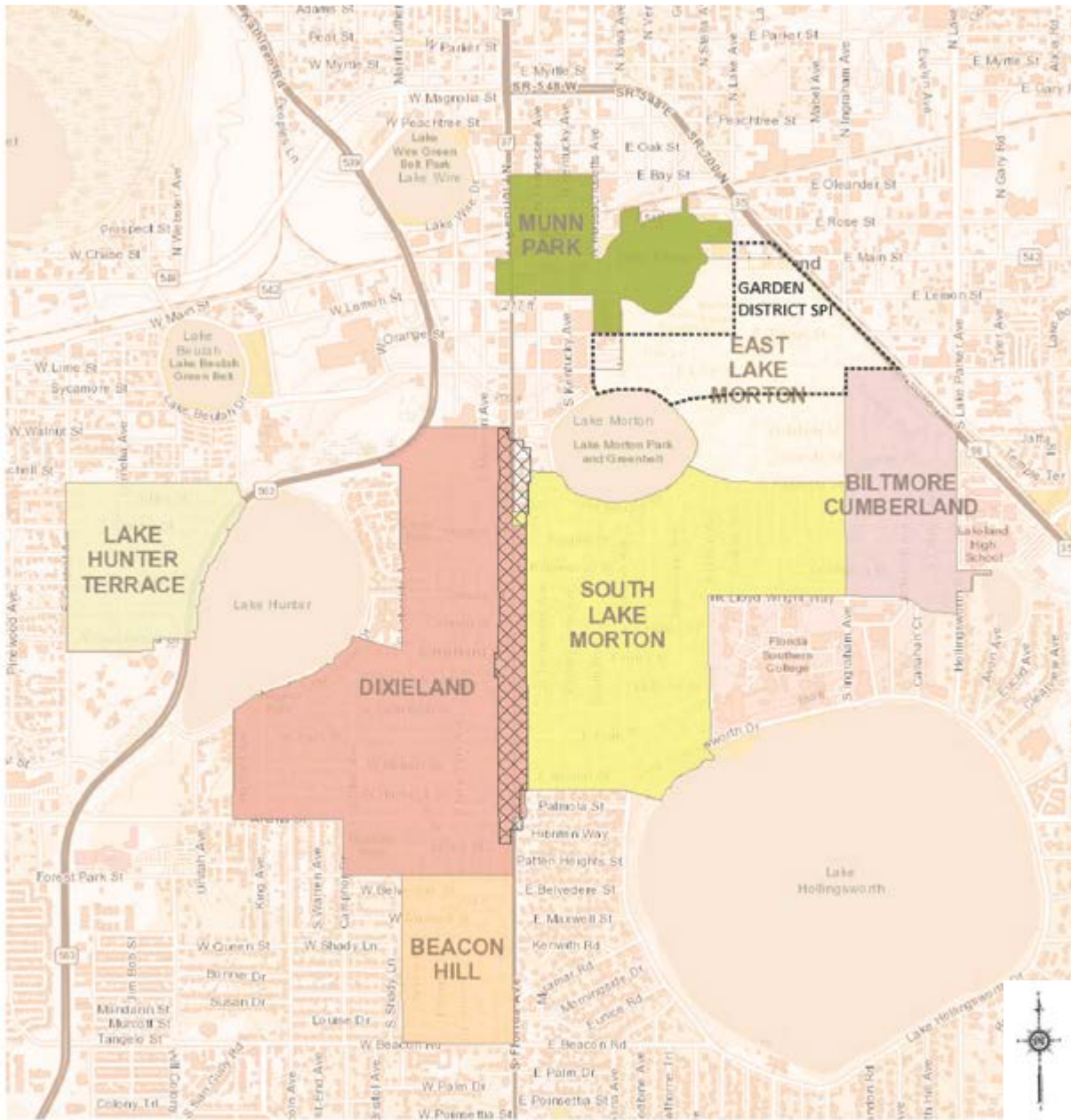

Note: Hatched area covers the Dixieland CRA Commercial Corridor

Figure 3.1: Lakeland Historic Districts Map

3.1 MUNN PARK HISTORIC DISTRICT

**(Local Designation: 1980;
National Register of Historic Places: 1997)**

The Munn Park Historic District represents the urban, commercial downtown and central business district of the City of Lakeland, established January 1, 1885. Development began in this area during the late 1870s with land subdivisions recorded by Herman Shipman’s Survey and Abraham G. Munn’s Survey, which laid out the city in a grid network of streets and avenues, alleys, and walkable blocks surrounding Henry Plant’s South Florida Railroad. Within the District, this pattern of development is still evident in its narrow two-way streets, ample sidewalks, decorative street lamps, network of alleys, and building setbacks, as well as the existence of Munn Park at its center for which the District was named. Munn Park has served as the City’s public square since its founding and was restored in 1990.

The earliest downtown buildings were of frame construction and many were destroyed by three fires in the early 1900s. Those that survived the fires were gradually replaced with more permanent masonry structures in the early decades of the 20th century. Most historic buildings in this District are two- and three-story buildings with retail shops, offices, or restaurants on the first floor and offices or residences on the upper floors. Several taller buildings exist as a testament to the exuberance and optimism of the 1920s Florida land boom era in which they were built, including the Terrace Hotel, Marble Arcade, Polk Theatre, and Lake Mirror Tower (former New Florida Hotel). The District encompasses Lake Mirror and includes the City Beautiful-inspired Frances Langford Promenade, as well as the Coca-Cola Bottling Company Building (current Lakeland Fire Dept. Administration Building), Lakeland City Hall, and All Saints’ Episcopal Church. The District is bordered on the north by Bay Street,



Source: Flickr
Photography by: Steven Martin

the east by Massachusetts Avenue and E. Main Street extending around Lake Mirror, the south by Orange and Lemon Streets, and on the west by Florida Avenue. Florida Avenue is a major transportation artery through Lakeland and is designated as Florida Highway 37 (FL-37).

Areas of special character within the District include the Lemon Street Promenade between S. Florida Avenue and S. Massachusetts Avenue, which contains a tree-lined public art display; Munn Park, which is Lakeland’s first park and “living room;” and the Neoclassical Francis Langford Promenade,

a 1928 City Beautiful Movement-inspired civic center and icon of downtown Lakeland.

With a period of significance between 1884-1946, the District reflects several of Florida’s historic contexts, which informs its historic architecture: Post-Reconstruction Period (1877-1898), Turn-of-the-Century Period (1898-1918), Boom Time Period (1919-1929), and the Depression and New Deal Period (1929-1940). Prominent architectural styles consist of Classical Revival, Colonial Revival, Art Deco, Mediterranean Revival, and Masonry Vernacular.



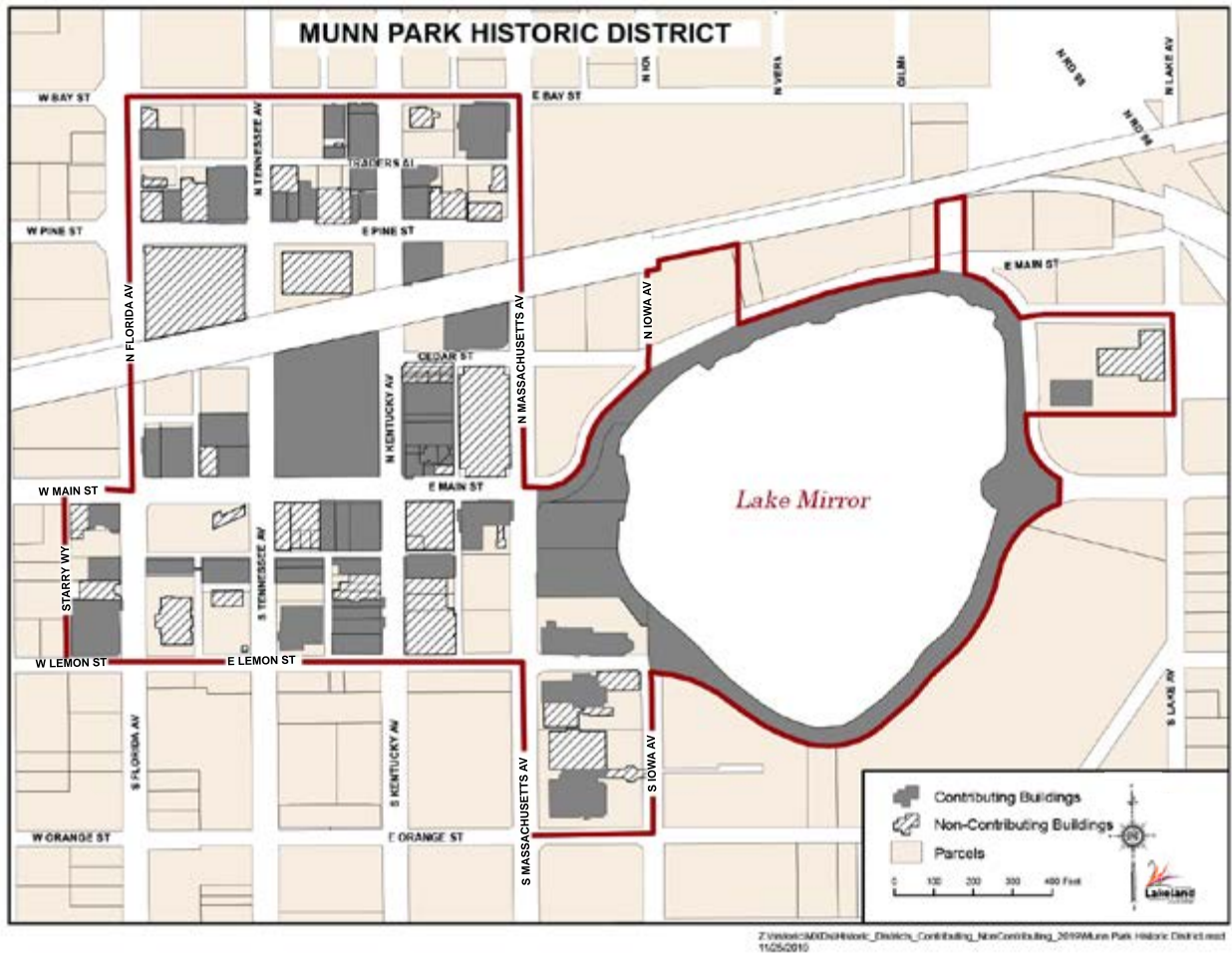

Figure 3.2: Munn Park Historic District Map

3.2 BEACON HILL HISTORIC DISTRICT

**(Local Designation: 1994;
National Register of Historic Places: 1993)**

The Beacon Hill, Alta Vista, and a portion of Mershons subdivisions make up the Beacon Hill Historic District, which were platted during the Florida Land Boom era of the 1920s and give the local District its name. Located a mile and a half south of downtown, Beacon Hill consists of approximately ten blocks south of the Dixieland Historic District (boundaries of both Districts are contiguous) west of S. Florida Avenue, north of Beacon Road, and east of Fairview Avenue. When first developed in 1923, this District was considered “out in the country” and was surrounded by many orange groves.

Within this District, two distinct residential neighborhoods exist: Alta Vista to the north, which comprises W. Belvedere and W. Maxwell Streets, and Beacon Hill to the south, which consists of six

streets named for Native American tribes (Pueblo, Comanche, Cherokee, Pawnee, Seminole, and Shawnee Trails). While some of the historic homes in the Alta Vista neighborhood are larger and more ornately decorated than the modestly-designed houses in Dixieland, the east-west street orientation and lot pattern is similar. However, sidewalks do not exist on Belvedere and Maxwell Streets, and no alleys are present in this District. The Beacon Hill neighborhood is suburban in character with its curvilinear street system and larger lots. The District is characterized by its expansive tree canopy, and the Live Oak is used as its neighborhood symbol.

The historic housing stock in this District was built primarily in the 1920s and consists of one and two-story dwellings. A wide variety of architectural styles are present, including frame and masonry vernacular, Colonial Revival, Tudor, Mediterranean Revival, Chateausque, Italianate, Dutch Colonial



Revival, Monterey, Ranch, and modest Queen Anne. As in other historic districts, the Bungalow style is the most common. Most of the residences are one- and two-story wooden frame homes. From its earliest days, this neighborhood tended towards upper-middle class and boasted many mayors and state legislators as residents.

As the eastern boundary of this District is located

along S. Florida Avenue, most of the properties in this commercial corridor have been converted to office use. Several of these properties still contain historic buildings that contribute to the generally residential character of the District.

The period of significance for this District is 1923 – 1945, which spans the Boom Time and New Deal historic contexts.



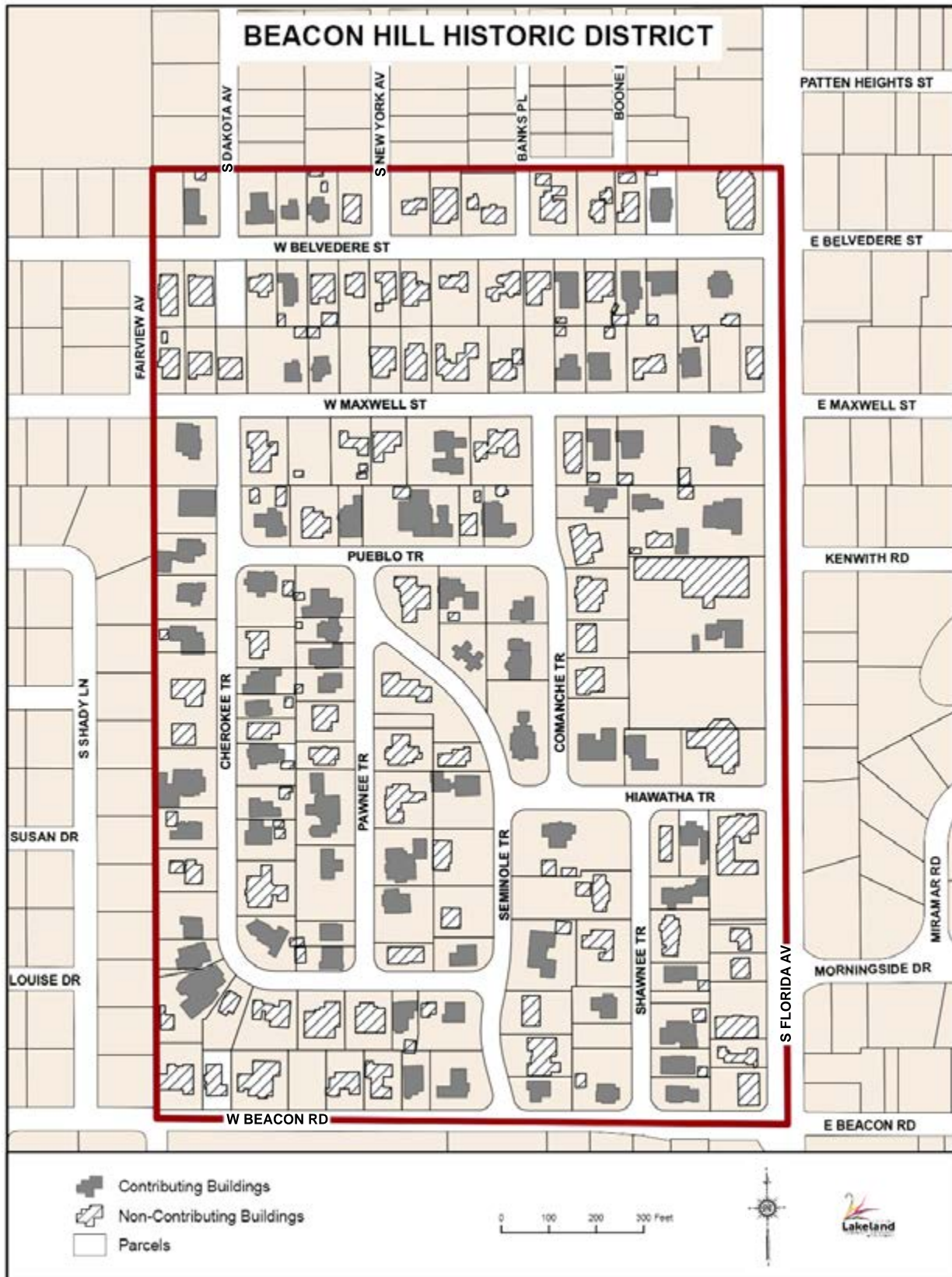

Z:\historic\MXD\Historic_Districts_Contributing_NonContributing_2019\Beacon Hill Historic District.mxd
11/25/2019

Figure 3.3: Beacon Hill Historic District Map

3.3 BILTMORE-CUMBERLAND HISTORIC DISTRICT

**(Local Designation: 2004;
National Register of Historic Places: 2004)**

The Biltmore-Cumberland Historic District is located east of Lakeland's downtown and the Lake Morton Historic Districts. The establishment of Florida Southern College to this District's south in 1922 prompted the opening of the Biltmore-Cumberland subdivisions, which consist of all or parts of sixteen blocks east of Ingraham Avenue, west of Hollingsworth Road, south of E. Lime Street, and north of Frank Lloyd Wright Way. The District is largely laid out along an east-west and north-south grid arrangement, but the blocks are of varying sizes and some streets are not continuous. The northern portion of the District, north of E. Palmetto Avenue, has an irregular shape due to the diagonal alignment of Francis Boulevard and Biltmore Place; with its landscaped divider and wide lanes, the layout of Francis Boulevard is reminiscent of City Beautiful

movement ideals. While most streets within the District are paved with asphalt, some brick streets remain. The mature tree canopy in this District provides a shady environment.

Thematically, Biltmore-Cumberland is more suburban in character than the nearby East and South Lake Morton Historic Districts. The relatively narrow lots feature modest building setbacks and some homes from the 1940s and 1950s feature single width, front-facing carports or garages. Sidewalks are not common along many streets. The typical historic house rises between one and two stories, and most facades retain their original detailing with exterior walls of horizontal wooden siding or stucco, although concrete block and asbestos shingle appear on later dwellings. Gable and hip roof types are common, as are front porches. Stoops exist on homes built in the 1940s and 1950s.



This District embodies the frenzied nature of development by local and out-of-state investors during the Florida Land Boom, the unfulfilled expectations of some of those developers, and the resumption of significant construction in the post-World War II interval. The District was subdivided by some of Lakeland’s most prominent builders and developers of the 1920s, including William P. McDonald, John E. Melton, Gertrude Overstreet, and Paul H. Calvin.

Houses in this District are representative of its professional and middle-class residents. Most of the houses are derived from the vernacular tradition for this area, which reflects the modern architectural styles common in the late 1940s and early 1950s. Typical of this era, Masonry Vernacular construction is predominant. However, a few of

the structures display the influences of the Colonial Revival, Craftsman/Bungalow, Mediterranean Revival and Tudor Revival styles, which is consistent with national and statewide trends in architecture. The District possesses an important concentration of buildings united historically by plan and physical development. These dwellings contribute to Lakeland’s sense of time, place, and historical development through their location, design, materials, workmanship, feeling, and association, providing an architectural link to the heritage of Lakeland.

The period of significance for this District is 1922 to 1953, which spans the Boom Time, New Deal and the beginning of the Post-War Boom historic contexts.



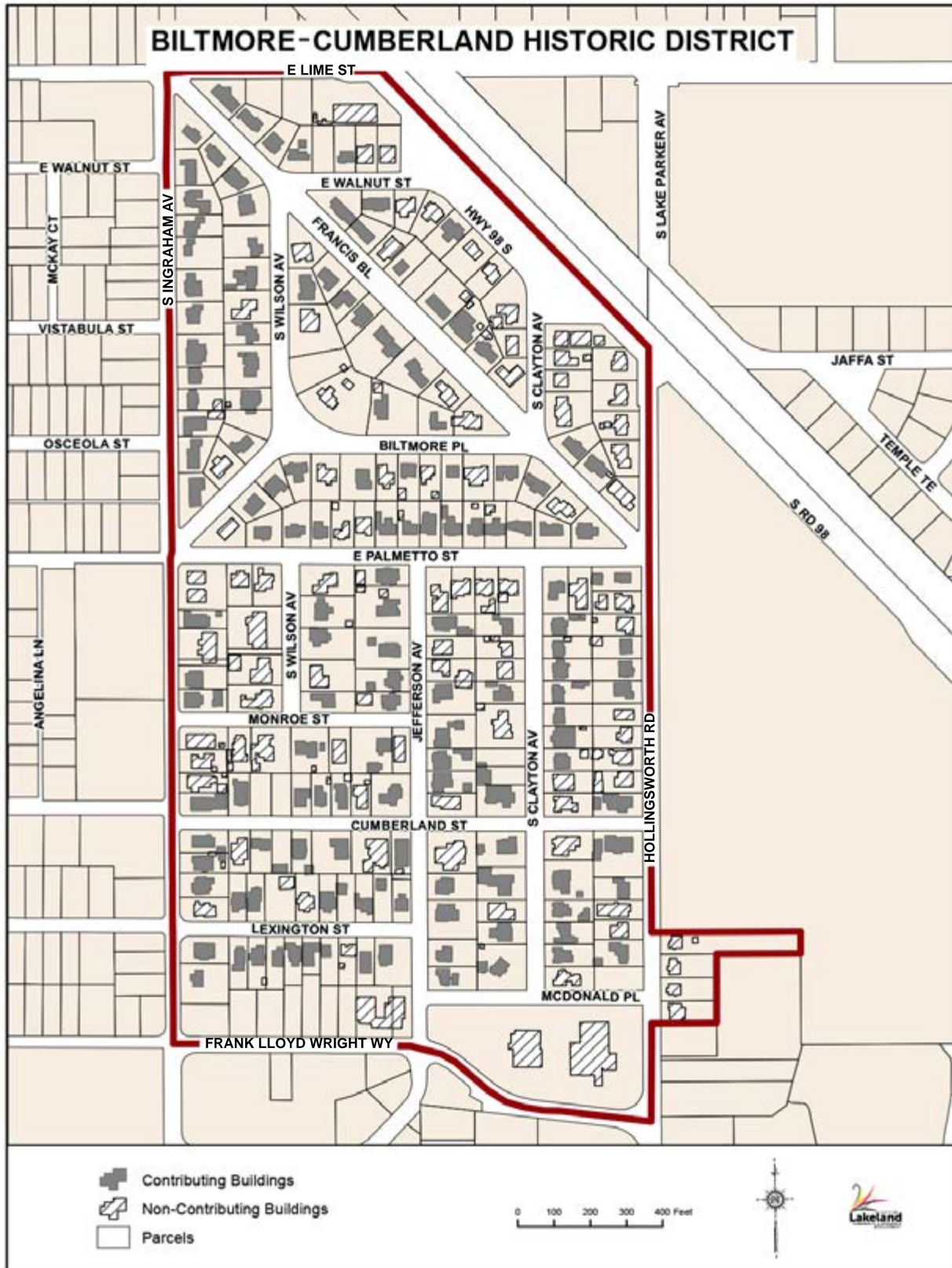

Figure 3.4: Biltmore-Cumberland Historic District Map

3.4 DIXIELAND HISTORIC DISTRICT

**(Local Designation: 1995;
National Register of Historic Places: 1994)**

Located between the east shore of Lake Hunter and S. Florida Avenue is the Dixieland Historic District. This District reaches north to the southern boundary of “downtown” Lakeland along Walnut Street and is anchored on the south by Dobbins Park. One of the Lakeland’s traditional urban neighborhoods, it contains a typical grid pattern of streets and alleys, narrow lots, sidewalks, and a mature tree canopy. Many brick streets still exist, but most are paved in asphalt.

On the District’s eastern border, S. Florida Avenue represents a commercial corridor featuring offices, shops, and other consumer services; this area encompasses the Dixieland CRA (Community Redevelopment Agency) Commercial Corridor, both a designated redevelopment area and a Special

Public Interest District, and is subject to separate Design Guidelines.

This District was established as an essentially blue-collar working-class neighborhood following the platting of the historic Dixieland subdivision. Originally conceived by prominent developers John Patterson, Edward Finney, and John F. Cox, the subdivision was acquired and subsequently revised by the Carter-Deen Realty Company in 1907, creating approximately 600 lots. Building was slow until the 1920s, when the population of Lakeland, and demand for residences, increased. Bungalows were particularly popular in this District as inexpensive but comfortable, modern, and expandable housing. The proximity to downtown Lakeland made Dixieland a popular place to live. While building construction tapered off during the Great Depression, a small number of contributing houses were built during this time.



While a few small churches exist in this District, along with the historic Dixieland elementary school, the majority of historic buildings are residential in nature. The Craftsman Bungalow architectural style is predominant, but Colonial Revival, Neoclassical, Mediterranean Revival, and Spanish Mission dwellings also exist. The frame vernacular style also accounts for a large portion of homes. Homes in this district are mainly one and two-story structures, and feature building setbacks close to the

street. Attached porte cocheres and detached garages are common. Common building materials consist of wooden siding, stucco, and brick. As a working-class neighborhood, architectural ornament and decoration is minimal.

The period of significance for this District is 1905 to 1940, which spans the Turn-of-the-Century, Boom Time, and New Deal historic contexts.



Dixieland Community Redevelopment Area and Special Public Interest District

The commercial corridor along South Florida Avenue in Dixieland developed originally as a suburban extension of the City’s downtown. It consists of a linear corridor from Walnut to Lenox Streets consisting of businesses serving the residents of the nearby neighborhoods and beyond. With the widening of South Florida Avenue in the 1980s and the development of newer commercial areas in the city, this corridor went into decline. As a gateway into Lakeland’s downtown and an area with both historic and current value, the City implemented several programs to stabilize and improve this area.

In 2001, the Dixieland Community Redevelopment Area (“CRA”) was created to aid in the revitalization of the commercial properties along South Florida Avenue within the Dixieland Historic District. A redevelopment plan was also developed along with design guidelines that specifically address properties in the Dixieland CRA Commercial Corridor.

In 2004, a Special Public Interest (“SPI”) District was adopted to further the redevelopment goals established by the CRA. This SPI regulates property development and redevelopment in the Dixieland CRA and Commercial Corridor.



3.5 LAKE HUNTER TERRACE HISTORIC DISTRICT

(Local Designation: 2002;
National Register of Historic Places: 2002)

Located on the western shore of Lake Hunter, this District is located southwest of Lakeland’s downtown. Although the widening of Sikes Boulevard distanced the neighborhood from Lake Hunter, it still maintains much of the natural beauty and characteristics that have always made it a charming

place to live. Gently sloping brick streets laid out in a traditional grid, a mature tree canopy, and a concentration of unaltered older homes contribute to the character and sense of community in this small historic district.

Suburban in character, this District was originally subdivided in the early 1900s, mainly by prominent developer John E. Melton. This District takes



in parts of seven historic subdivisions, comprising approximately 65 acres. Due to the availability of lots in Dixieland and the Lake Morton Districts, this District remained largely undeveloped through the early twentieth century. In fact, platted vacant lots still exist today. Two thirds of building construction in this District took place during and immediately following World War II. The majority of buildings in the District occupy narrow lots oriented on a north-south axis and display moderate setbacks from the street. Like Dixieland, this District was established to accommodate the housing needs of Lakeland’s working-class residents.

The District contains a well-defined concentration of buildings displaying wood frame and masonry vernacular architecture, as well as Classical Revival, Mediterranean Revival, and Craftsman/Bungalow styles. The typical residence is one to two stories in height, rests on brick piers, and has a front porch or stoop. Gable and hip roof types exist, and many homes have an attached carport, detached garage, or in later styles, an attached one-car garage.

The period of significance for this District is 1924 to 1951, which spans the Boom Time, New Deal, and Post-War Boom historic contexts.



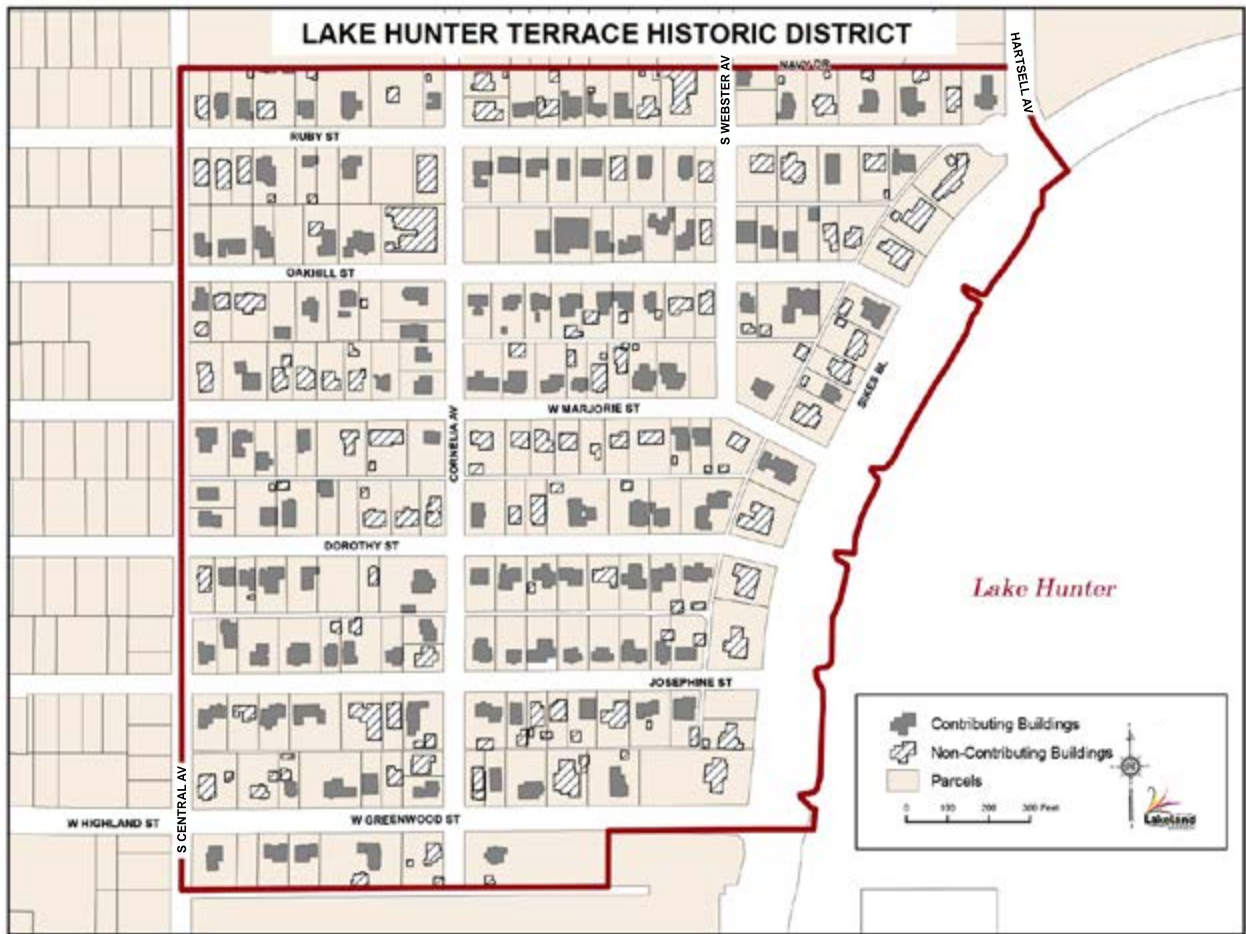

Figure 3.6: Lake Hunter Terrace Historic District Map

Z:\HistoricMND\Historic_Districts_Contributing_NonContributing_2019\Lake Hunter Terrace Historic District.mxd 11/25/2019

3.6 SOUTH AND EAST LAKE MORTON HISTORIC DISTRICTS

**(Local Designation: 1989 and 1994;
National Register: 1985 and 1993)**

The South and East Lake Morton neighborhoods (the Lake Morton Historic Districts), are located primarily south and east of Lake Morton, north of Lake Hollingsworth, and west of Ingraham Avenue. While the character of these Districts is considered urban today, they represent the first-generation suburbs of Lakeland. Land located to the south of downtown and the railroad was considered more desirable for residential development in the early twentieth century. The development of these neighborhoods began around 1906, but most of the houses were built during the Florida Real Estate Boom between 1920 and 1926. This era provides the basis for the predominant architectural character of Bungalow and Mediterranean Revival styles. The area's rolling topography, mature tree canopy, and occasional angular streets and lake shores provide pleasant spaces

and vistas, creating a character unique in Lakeland and rare in Florida cities.

Both Districts were laid out in a grid pattern encompassing numerous historical subdivisions established by Lakeland's prominent early developers such as John Morton, brother-in-law of Lakeland founder Abraham Munn, the Carter brothers, Columbus Deen, John Patterson, Edward Finney, and John Cox. This grid pattern is enhanced with a network of alleys and sidewalks. Many of the streets in these Districts are paved with original or replacement brick. Lots within these Districts are generally narrow, with building setbacks close to the street. While the narrow lot configuration exists within the East Lake Morton District, several lots between E. Lime Street and E. Lemon Street are up to 200 feet in depth, which are uncharacteristically and unusually deep.



Areas of special character within these Districts include the Florida Southern College campus, the East Palmetto Street and Frank Lloyd Wright Way commercial corridors, and the Garden District. Located between the northern shore of Lake Hollingsworth and Frank Lloyd Wright Way at the southern boundary of the South Lake Morton Historic District, the Florida Southern College campus features nine buildings and structures designed and built by famed architect Frank Lloyd Wright between 1938 and 1955, as well as several other historic college buildings from the 1920s. East Palmetto Street between Lake Morton Drive and Michigan Avenue is a neighborhood commercial corridor that includes the Lakeland Public Library, the Polk Museum of Art, and several other architecturally significant commercial buildings. Another neighborhood commercial corridor exists along Frank Lloyd Wright Way between South Florida Avenue and Pennsylvania Avenue, which includes historic

buildings serving light commercial uses with easy accessibility from the neighborhood’s residents. Finally, the Garden District is a Special Public Interest (SPI) District overlaid on a portion of the East Lake Morton Historic District that is a designated redevelopment area allowing additional land uses not otherwise permitted under the base zoning for these properties. A portion of the properties located in Sub-Districts 2 and 4 within the Garden District SPI are eligible for building height bonuses of four stories, not to exceed 40 feet (Sub-District 2) or 60 feet (Sub-District 4). The Garden District is prime for mid-rise, multi-family and mixed-use redevelopment designed to fit in with the existing historic fabric.

Architectural styles exemplified in these Districts include the Craftsman/Bungalow, frame vernacular, Classical Revival, Mediterranean Revival, Spanish Mission, and Tudor Revival styles. A few



community churches, schools, and apartment complexes occupy large footprints within the Districts. Aside from these community organizations, the residential buildings within the Districts are primarily one to two stories on raised foundations and feature prominent porches. Porte cocheres and detached garages and/or accessory buildings are common throughout the area. As these Districts represent the

first-generation suburbs of Lakeland, many of the homes were built for prominent citizens and therefore display a high degree of architectural integrity, quality, and neighborhood cohesiveness.

The period of significance for this District is 1900 to 1942, which spans the Turn-of-the-Century, Boom Time, and New Deal historic contexts.



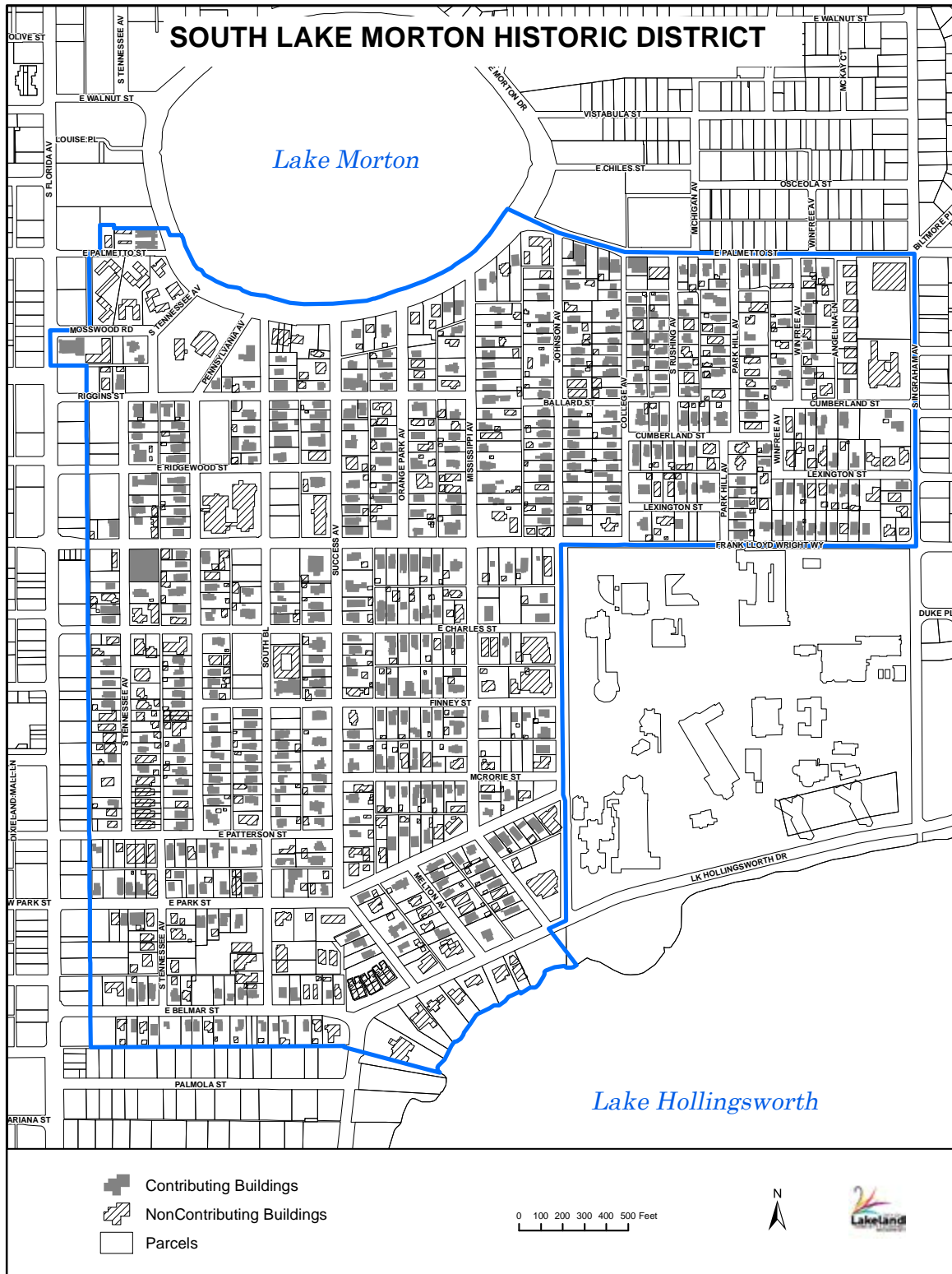

Z:\historic\MXD\Historic_Districts_Contributing_NonContributing_2019\South Lake Morton Historic District_Update_11-6-2020_11/6/2020

Figure 3.7: South Lake Morton Historic District Map

Garden District Special Public Interest District

In 2002, the Garden District Special Public Interest (“SPI”) District was adopted by the City of Lakeland. Located generally north of E. Walnut Street, west of Iowa and S. Lake Avenues, and east of Bartow Road, this SPI was created to provide an incentive and a mechanism for quality infill development and redevelopment, as well as to allow for mixed-use and expanded land uses. While development regulations affecting building design were included originally in this SPI, these regulations have since been removed. Some properties included in the SPI that were not originally included within the

East Lake Morton Historic District were added to this District as a result of the SPI’s adoption. These properties are included only in the local historic district designation, and are not included as part of the National Register of Historic Places designation of this District. These properties are protected by design review and are eligible for expanded land uses, and in some cases for building height bonuses, by this SPI designation. The Garden District is subdivided into six Sub-Districts, which define permitted land uses and building height bonuses.

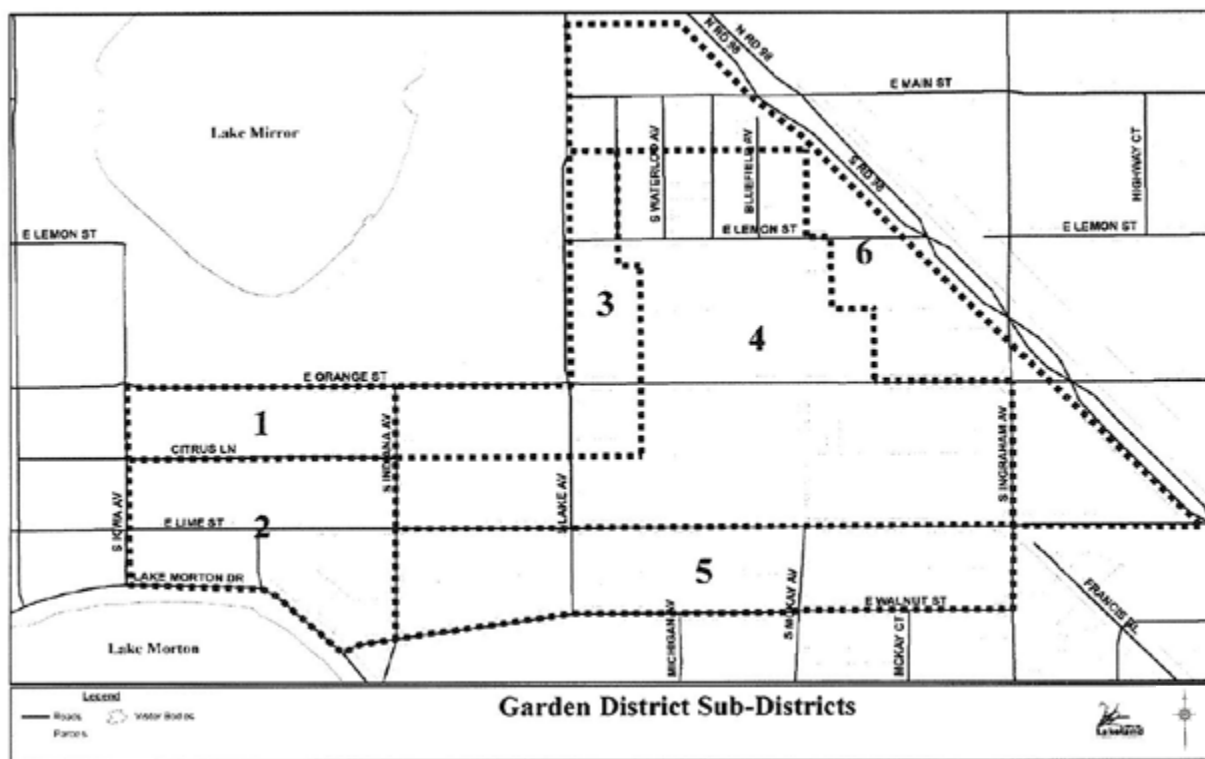

Figure 3.9: Garden District Sub-Districts Map

3.7 OTHER HISTORIC RESOURCES

In addition to the seven historic districts, the City of Lakeland has several individual structures that have been designated as Local Historic Landmarks. They include a diverse range of building types that were designated by either a City of Lakeland Ordinance, the National Register of Historic Places, or by both. These other historic resources include the following:



*Courtesy Historic Lakeland, Inc.,
David Dickey, photographer*



- **All Saints Episcopal Church, c. 1923**
202 S. Massachusetts Avenue
Date Listed: 8/2/1982 by Lakeland Ordinance
No. 2756

- **Central Avenue School, c. 1926**
604 S. Central Avenue
Date Listed: 7/22/1999 on the National Register
of Historic Places, #99000865



- **Carpenter's Home Entrance Arch, c. 1926**
I-4 and Carpenter's Way
Date Listed: 8/7/1990 by Lakeland Ordinance
No. 3378



- **Cleveland Court School, c. 1929**
328 E. Edgewood Drive
Date Listed: 7/22/1999 on the National Register
of Historic Places, #99000862



*Courtesy Historic Lakeland, Inc.,
David Dickey, photographer*

- **Griffin Grammar School, c. 1932**
3315 Kathleen Road
Date Listed: 6/5/2007 on the National Register of Historic Places, #07000509



- **John F. Cox Grammar School, c. 1928**
1005 N. Massachusetts Avenue
Date Listed: 7/22/1999 on the National Register of Historic Places, #99000864



- **Henley Field Ball Park, c. 1925**
1125 Florida Avenue
Date Listed: 5/23/1997 on the National Register of Historic Places, #97000458



*Courtesy Historic Lakeland, Inc.,
David Dickey, photographer*

- **Lake Mirror Promenade (now known as the Frances Langford Promenade), c. 1928**
Generally between S. Massachusetts Ave. and S. Lake Ave. and, Lemon St. and Lake Mirror Dr.
Date Listed: 2/1/1982 by Lakeland Ordinance No. 2681 and 1/27/1983 on the National Register of Historic Places, #83001437



- Oates Building, c. 1925**
 230 S. Florida Avenue
 Date Listed: 7/28/1995 on the National Register of Historic Places, #95000925



*Courtesy Historic Lakeland, Inc.,
David Dickey, photographer*

- Park Trammell Building, c. 1926**
 35 Lake Morton Drive
 Date Listed: 8/2/1982 by Lakeland Ordinance No. 2757



- Old Lakeland High School, c. 1927**
 400 N. Florida Avenue
 Date Listed: 9/30/1993 on the National Register of Historic Places, #93001027



- Polk Theatre and Office Building, c. 1928**
 125 S. Florida Avenue
 Date Listed: 4/2/1984 by Lakeland Ordinance No. 2910 and 5/27/1993 on the National Register of Historic Places, #93000446



- Sorosis Building, c. 1928**
 90 Lake Morton Drive
 Date Listed: 8/2/1982 by Lakeland Ordinance No. 2755



- Wilson-English Residence, c. 1909**
 415 S. Kentucky Avenue
 Date Listed: 5/15/2000 by Lakeland Ordinance No. 4067



- Southside Cleaners & Sign, c. 1953**
 901 S. Florida Avenue
 Date Listed: 2/18/2008 by Lakeland Ordinance No. 4671



- Winston Elementary School, c. 1928**
 3415 Swindall Road
 Date Listed: 12/20/2001 on the National Register of Historic Places, #01001362

- **Florida Southern College**

Because of its association with and buildings designed by famed American architect Frank Lloyd Wright, Florida Southern College was designated a National Historic Landmark District by the National Park Service in 2012, and has been listed on the National Register of Historic Places since 1975. National Historic Landmarks are places with exceptional significance to the history of the United States. While Florida Southern College is not designated as a City of Lakeland local historic district, its historic buildings are technically protected by the City’s Historic Preservation Standards. Because the College has an internal review process for alterations

to its buildings, design review is not typically handled by the City’s Historic Preservation Board and Design Review Committee.

Overlaid onto the Florida Southern College property is also a Special Public Interest District (“SPI”), adopted by the City in 1983 and amended several times, that regulates land use and development on campus. The SPI contemplates redevelopment and new development on the College’s campus, and also mitigates adverse impacts to the South Lake Morton and Biltmore-Cumberland Historic Districts.



Historic or Landmark Signs



Please see [Appendix 8.2](#) for information about existing Historic or Landmark Signs and the process for their designation.

4



HISTORICAL DEVELOPMENT PATTERNS AND NEW CONSTRUCTION



CHAMBER/COMMERCE
MAP OF
LAKELAND
FLORIDA

LEGEND
...
COMPILED BY
STANFORD HALL
1905

4.1 RESIDENTIAL ZONING IN HISTORIC DISTRICTS

In addition to these Guidelines, zoning and land development regulations play a major role in preserving the community design framework and other physical conditions in the City’s historic districts. [Article 11: Historic Preservation Standards](#) of the Land Development Code defines criteria for existing historic properties, as well as new infill development that is appropriate for these areas.

A majority of Lakeland’s historic building fabric is concentrated in the six residential historic districts situated near the center of the city and one commercial historic district in the Downtown area. The six residential districts have either a RA-1, RA-3, RA-4, MF-12, or MF-22 zoning designation. The RA zoning designation permits detached single-family houses at lower densities on lots that are consistent with established neighborhood development patterns. Where properties meet certain site development criteria, other building types such as accessory dwelling units, cottages, and single-family attached structures may be permitted in RA zoning districts with either Compatibility Review or Conditional Use approval from the Planning and Zoning Board. Under both the RA and MF zoning designations, new principal residential infill structures are required to include a front porch or stoop feature to be consistent with existing neighborhood architectural patterns. MF zoning designations

permit multi-family residential densities that range from twelve to twenty-two dwelling units per acre, including small apartment buildings. For further information on development regulations required by a property’s zoning designation, see [Article 3 of the City’s Land Development Code](#).

Both the RA and MF zoning designations allow for modest increases in density in residential areas throughout the city and permit different types of infill multi-family residential structures. These include familiar building types such as triplexes, quad-plexes, townhouses, live-work units; and small apartment buildings. Relative to community design, these residential structures are often referred to as the “Missing Middle”. These are residential building types that are often missing from established neighborhoods or districts that can benefit from greater housing options, an expanded inventory of workforce/affordable housing, infill that strengthens the existing neighborhood fabric, and demographic diversity and densities that support a range of mobility options. These “Missing Middle” multi-family structures which are smaller in scale and massing to modern multi-family structures and often replicate historical multi-family structures, such as quad-plexes and Bungalow courts, are compatible infill building types for most of the City’s residential historic districts.



4.2 COMMERCIAL ZONING IN HISTORIC DISTRICTS

Existing historic commercial structures and new commercial infill development in the Munn Park Historic District, the Dixieland CRA Commercial Corridor, and some areas of the six residential districts are also subject to the Historic Preservation Standards. These properties are generally situated in C-1, C-2, C-6, C-7, and O-1 zoning districts. In addition to commercial and office uses, these zoning designations permit a variety of other single and mixed-use structures, as well as multi-family housing at densities similar to their respective contexts.

Repurposing historic commercial buildings with new uses has been an ongoing trend throughout the country for over fifty years. While this process is also regulated by the Land development Code, it infuses new life in these structures, brings them into compliance with modern code standards and extends their functional utility; adaptive use strategies and compatible infill development are major contributors to preserving the integrity of these historic commercial areas.

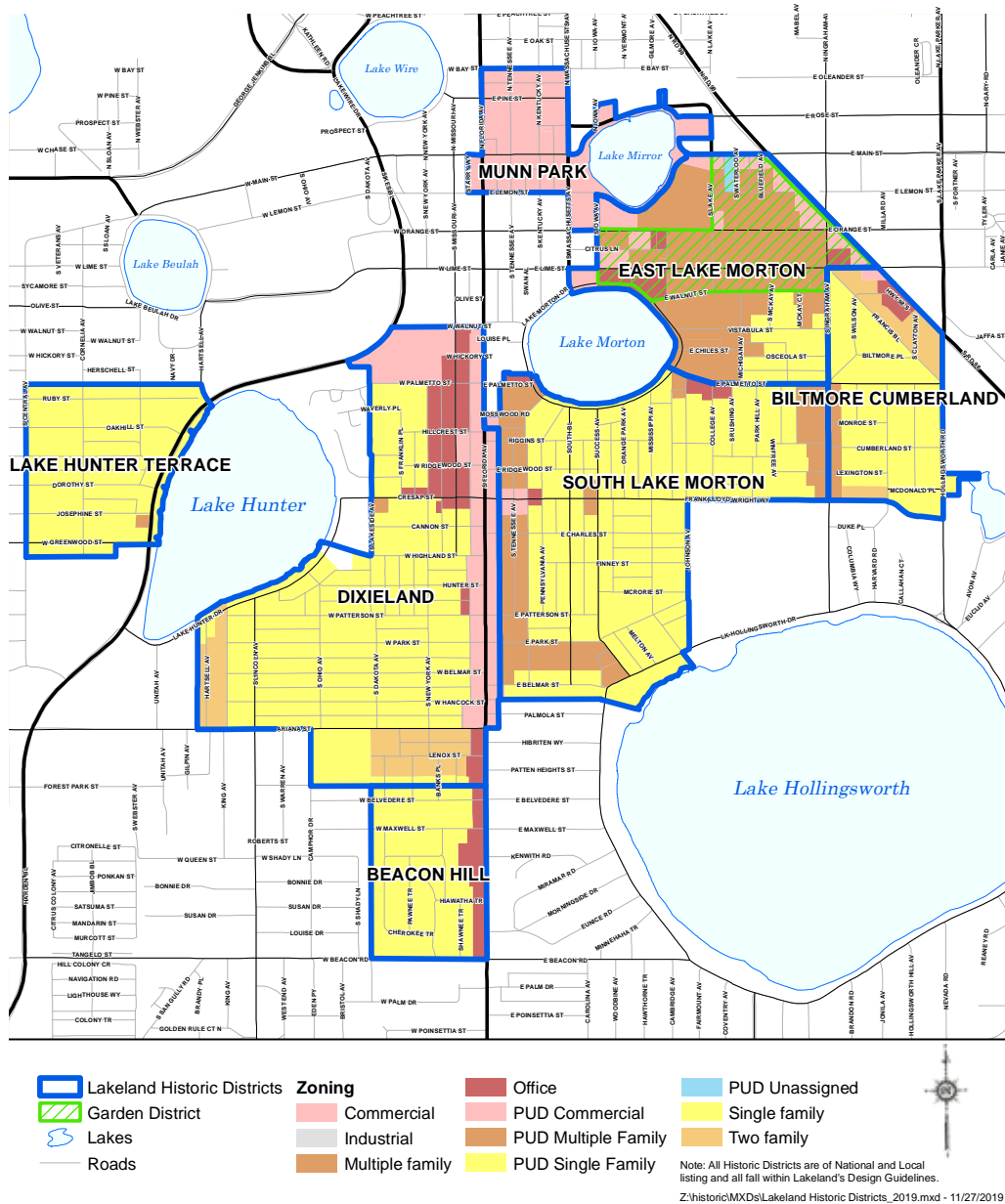

Figure 4.1: Zoning Map within Historic Districts

4.3 PUBLIC RIGHTS OF WAY

Street networks in many of the City’s historic districts were established when they were initially surveyed in the late 19th and early 20th centuries. The use of a rectilinear grid as the basic ordering system for both residential and commercial areas was common practice during that time. The resulting street and block system made it much easier to subdivide land for sale and ultimately, development. Although there are some variations in the City’s historic districts, the grid network of local streets provides

direct internal neighborhood connectivity and connectivity with adjacent areas. In the City’s historic districts, the “fixed” network of public rights of way is a major component of their respective contextual frameworks. As such, the configuration of public rights of way in historic districts provides a point of reference for a range of community design conditions such as siting new buildings, façade orientation and parcel accessibility.

Alleys



Brick Streets



4.3.1 HISTORIC BRICK STREETS

Brick streets are prominent features in many of Lakeland’s oldest neighborhoods. Currently, there is over 5.2 miles of brick roadways in the seven historic districts. These streets are components of the City’s larger transportation infrastructure network and were laid during the early part of the 20th century. This coincided with the 1920s Florida Land Boom when many communities around the state were expanding or just getting started and experienced a rise in personal automobile ownership. These brick streets were some of the City’s first improved or permanent roadways. Similar to other cities around the country, some brick roadways were removed or paved over starting in the late 1940s. Those that survive in Lakeland’s neighborhoods

should be preserved as historic public realm features that are integral to the built fabric of the City’s historic districts.

Where they exist, brick streets convey sense of distinctiveness and visual charm to the entire block. Historic brick streets are often perceived as unifying features for houses along the block, and also provide traffic calming in slowing down vehicular traffic. Brick streets that remain in the City’s historic districts should be preserved as neighborhood assets. New construction or other projects that alter existing brick streets should restore these features to their previous state.

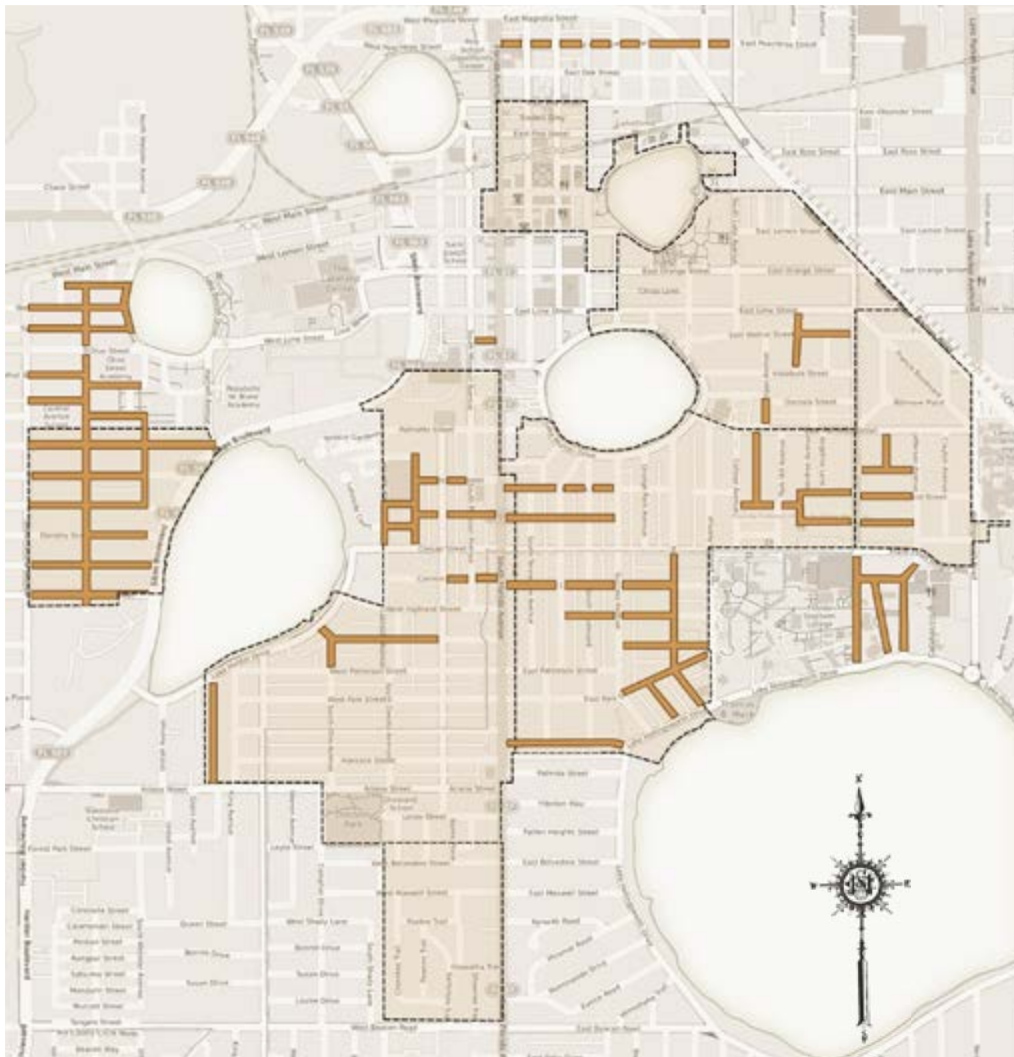

Figure 4.2: Historic Brick Streets

4.3.2 ALLEYS

Alleys are narrow laneways that typically split residential blocks lengthwise. They are public rights of way that provide secondary vehicular paths behind houses along the block. In the City of Lakeland, most alleys were laid out as part of historically platted subdivisions and are present in four of the City's historic districts. Today, there is over 37,000 linear feet, or approximately 7 miles of alleys in these historic districts. Historically, alleys have been regarded as “back of the house” spaces for parking, garage

and rear yard access, infrastructure features and other service-related activities, such as garbage pick-up. In older residential neighborhoods, these alleys are integral to the physical structure and usage patterns that have evolved over a century. Lakeland was incorporated in 1885. While alleys are regulated by the City's Land Development Code, they should be protected as traditional historic district features and spaces for accessing small scale infill development and accessory structures.

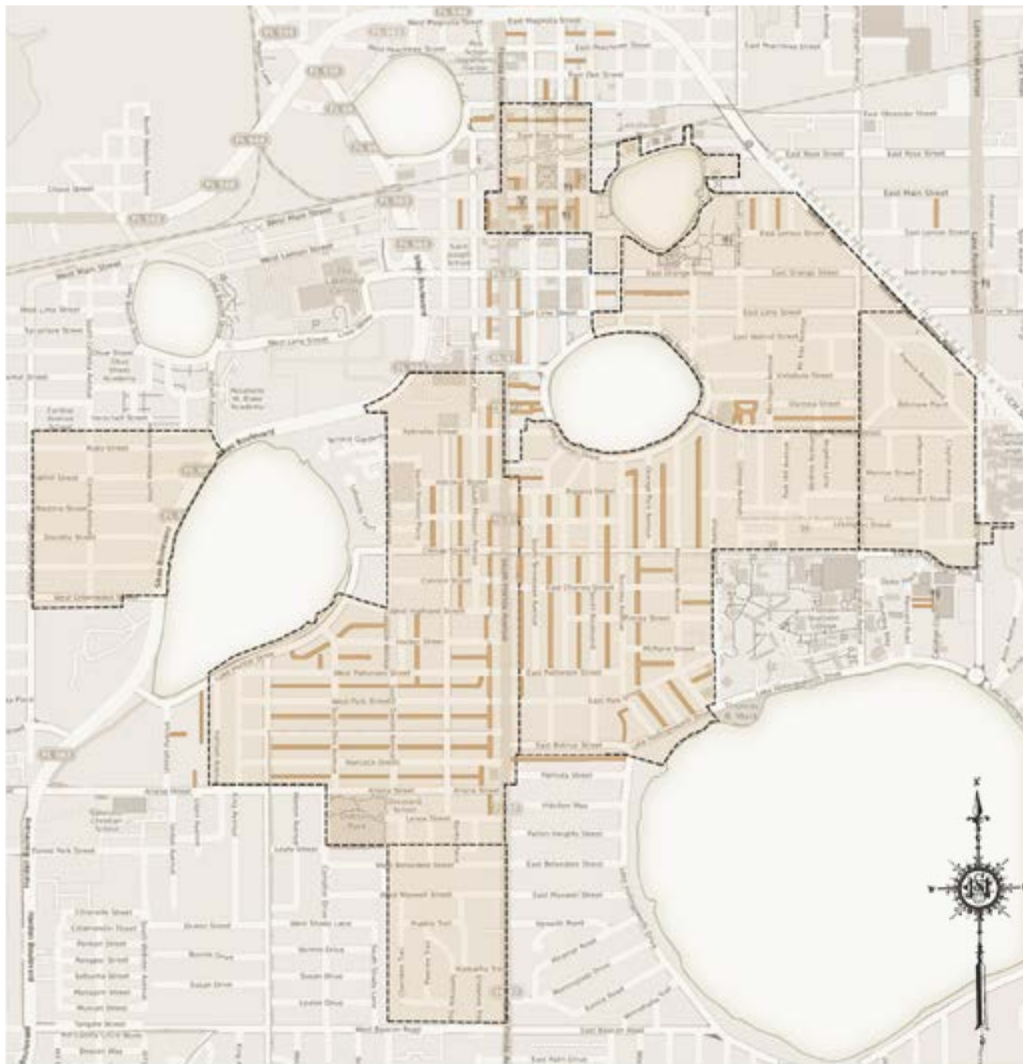
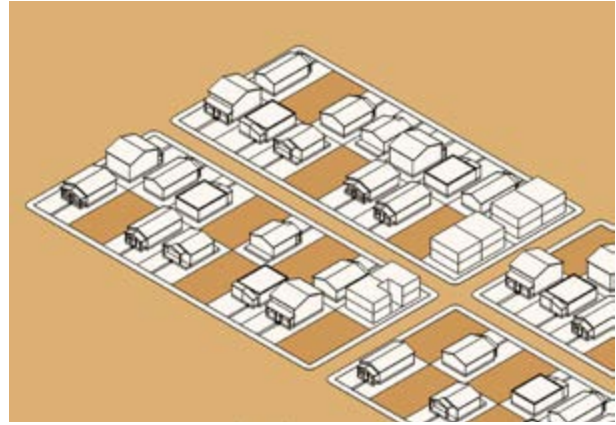

Figure 4.3: Alleys in Historic Districts

4.4 UNDERSTANDING NEIGHBORHOOD FORM



Aerial View of Historic Neighborhood Form



Typical Neighborhood Development Patterns

Lakeland’s historic districts evolved from the first platted subdivisions, both large and small, surveyed in the late 19th and early 20th centuries. Over time, these early neighborhoods developed the formal and traditional community design characteristics that are hallmarks of historic districts across the

country. As the oldest parts of the city, historic districts have two basic underlying formal characteristics that contribute to their overall coherence and legibility: their spatial organization, or the way they are laid out; and their three-dimensional form, or physical scale.



Historic Sanborn Maps of Portions of the East Lake Morton Historic District Indicating Early Development Patterns. Source: Library of Congress

From their beginnings, the City’s oldest neighborhoods evolved with a conventional grid pattern of straight streets and rectangular blocks. Blocks in these areas are consistently subdivided into individual lots flanking both sides of the street. This development pattern may vary slightly between districts, but functions as a standard community design framework for each historic neighborhood. The intact spatial order of the City’s historic districts,

which includes the fixed arrangement of houses on the block, the discernible visual clarity of the street and a noticeable sense of permanence, is one of their most recognizable characteristics. This order is an essential aspect of the physical structure of the City’s historic districts. It should be reinforced over time with infill development that is compatible, complementary and contributes to ongoing stability of these areas.



Figure 4.4: *Typical Block Face with Historic Houses*

The vertical height, scale, and massing proportions of individual houses along a block face contribute to the distinct form of each historic district. They are the three-dimensional formal characteristics of these neighborhoods that are visible from the street and public realm. Although individual houses vary stylistically, these one and two-story structures reflect both horizontal and vertical proportions, that contribute to the order and rhythm of the whole street, as well as the recognizable uniqueness of

each historic district. As such, the collective scale established by individual houses is a major component of the overall form of each district. To maintain the formal integrity of their blocks and streets, the scale of building addition and infill development in these areas should be adjusted to and reflect existing building massing, proportions, orientation, and siting recognizing a neighborhood’s scale as a fundamental community design condition in the City’s historic districts.



4.5 ADDITIONS

Principles for Additions

-Ensure that Historic Buildings Remain the Central Focus

An addition should not damage or obscure architecturally important details and materials of the primary structure or other resources on the site. Additions should be distinguishable from the original structure without distracting from it.

-False Historicism/Conjectural History is Discouraged

Design additions should reflect their era of construction while respecting the historic context and architectural style of the original structure. Avoid using architectural details for additions that are more ornate than those found on the original structure or that are not characteristic of the original structure's architectural character.

-Contemporary Interpretations of Traditional Designs and Details May be Considered

When applied to a compatible building form, contemporary materials, window moldings, doors, and other architectural details can provide visual interest while helping to convey the fact that the building or addition is new.

-Flexibility in Interpretations of Traditional Designs and Details May be Considered in Locations Not Visible from the Public Right-of-Way

All facades of a building are important; however, the highest level of scrutiny related to compatibility should generally be placed on additions that are visible from public right-of-way.

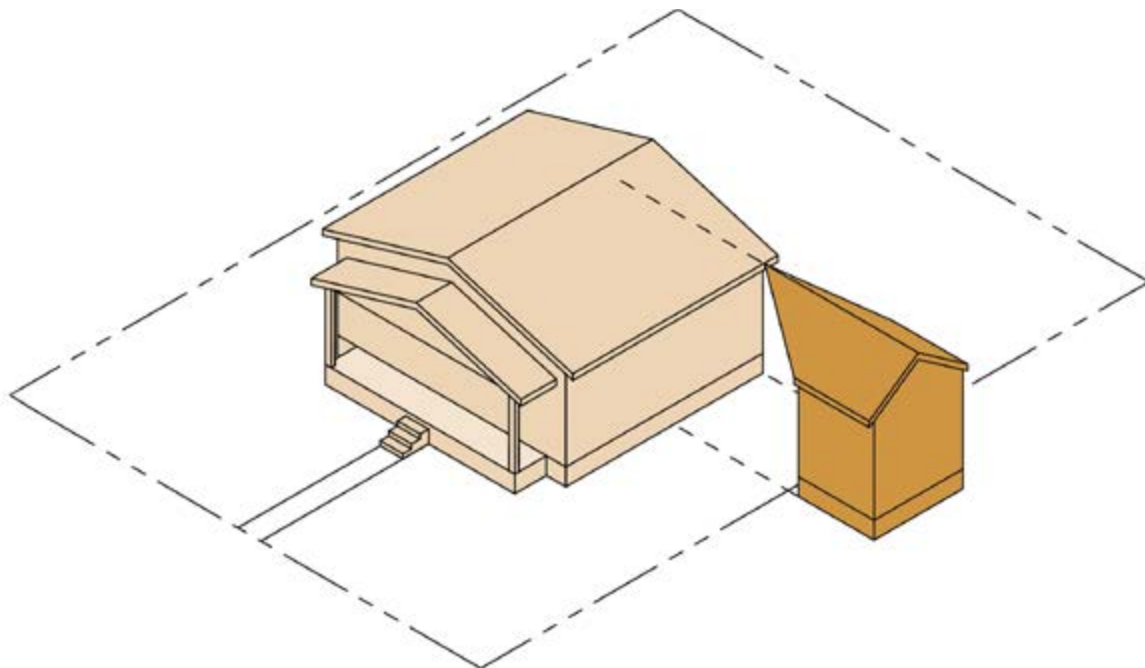

Figure 4.5: Addition to Existing Historic House

A number of the City’s historic houses would be considered small by today’s standards. In fact, Bungalow and some modern house types were designed to be small but expandable. Therefore, additions are expected on these houses. Additions to historic structures can have a significant effect on their appearance. Poorly designed additions can result in loss of architectural integrity, and should therefore be avoided. Architectural features that define the historic character of the building should not be significantly modified, covered up or damaged as a result of a new addition. Ongoing debate regarding the architectural “language” used for new additions suggest that they should directly reflect the character of the host structure, as opposed to the addition taking on a more contemporary architectural expression. The City of Lakeland prefers a blending of both of these philosophies for new additions to historic buildings. Additions may reflect contemporary construction methods that are based on the design, appearance and materials of the host structure. While they should be visibly related to the host structure, additions should not replicate the design of the historic host structure, as this could give a false sense of history about the building.

While additions enlarge a building’s footprint, they also enlarge the three-dimensional form of the structure. As such, the location, size, and character of an addition should be primary considerations for defining compatibility with the host structure and

adjacent houses within a historic neighborhood.

Traditionally, additions to historic houses were located at the rear of the structure, inset from the corners and often under a lower roof profile than that of host structure to differentiate the addition from the original structure. They also used similar materials and other architectural details as the host structure. To protect the integrity of the host structure and minimize their visual prominence from the street, it is preferable to locate additions at the rear of historic houses. Additions are also allowed on the side of the house for Bungalow, Colonial Revival, Frame Vernacular, Mediterranean Revival, and some Modern styled homes, however they must be located behind the primary façade and meet the site development criteria in Sub-Section 3.4 of the City’s Land Development Code.

With higher visibility from the street, the design of side additions should be of a compatible scale to the host structure and should not be overly large or obtrusive, nor compete with the scale of the host structure. Regardless of the amount of floor area incorporated into new additions, they should be perceived as secondary attachments to the host structure, and should be subordinate in massing to the host structure. The massing proportions of any addition should be compatible with the massing proportions of the host structure.



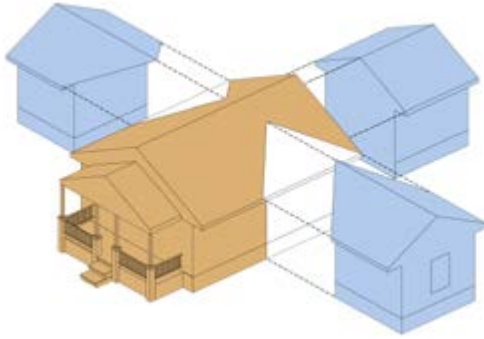

Figure 4.6: Side and Rear Additions Options for a Bungalow Structure

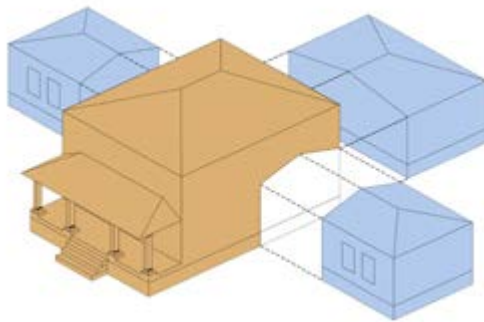

Figure 4.7: Side and Rear Addition Options for a Four Square Structure

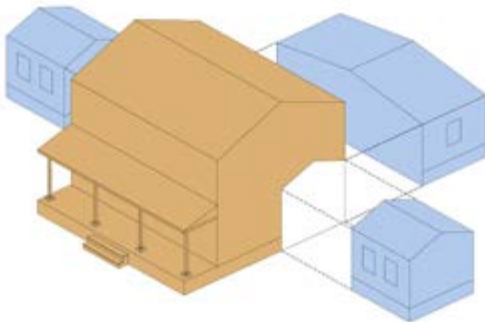

Figure 4.8: Side and Rear Additions for a Frame Vernacular Structure

Where lot area permits, garage additions may be located at the rear of the host structure. A garage addition at the rear of a structure should follow the same general design criteria as room additions to protect the integrity of the host structure and maintain an acceptable level of compatibility. Attached multiple-car garages are discouraged in all of the City’s historic districts. From the street, the visibility of large or multiple garage doors detracts from



Carport Addition



Carport Addition



Side Additions

the architectural character of the house and the perceived compatibility with the residential block.

Other types of additions or attachments to historic structures include porches and screen pool enclosures which should be located to the rear of the host structure and be subordinate in massing to the host structure.



ACCEPTABLE

- Additions that are undertaken after a determination has been made that the existing structure cannot accommodate new space requirements and will not alter the character of the host structure.
- Additions that protect and maintain original architectural features during construction.
- Additions that minimize the loss of any architectural details or features.
- Additions that are subordinate to and compatible with the style and scale of the host structure.
- Side additions that are located behind the principal street-facing façade, or rear additions that are unnoticeable from the street.
- Additions that are designed with some distinction between the historic house and non-historic features.
- Second story additions that are set back from the front of the house and inconspicuous from the street.
- Porch additions on side or rear elevations that enhance the character of the host structure and do not diminish the established architectural integrity of the host structure.
- Additions that are differentiated from the host structure, e.g. by a recess in wall plane, lower roof height, or vertical trim piece.



NOT-ACCEPTABLE

- Additions that are too large in scale that they compete with the massing proportions of the host structure.
- Additions that are incompatible or detract from the architectural style of the host structure.
- Additions that remove, damage, or destroy original architectural details or character-defining features.
- Additions that project into the front yard area beyond the principal façade of the host structure.
- Pool screen enclosure additions that overwhelm the massing of a historic house.

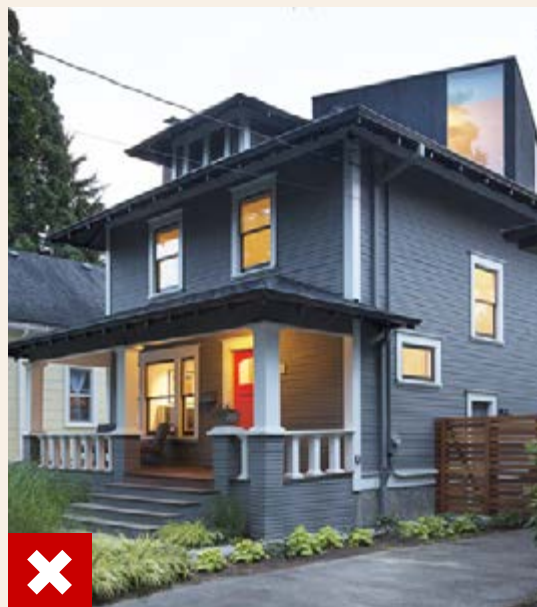

4.6 NEW RESIDENTIAL CONSTRUCTION AND INFILL DEVELOPMENT

Principles for New Construction

Ensure that Historic Buildings Remain the Central Focus

Carefully consider the historic context of the block and surrounding environment or historic district when designing a new structure. New construction should be distinguishable from historic structures without detracting from them.

False Historicism/Conjectural History is Discouraged

Attempting to create an exact replica of historic styles for new construction blurs the distinction between old and new buildings and makes the architectural evolution of the historic district more

difficult to interpret. While new construction within historic districts should not attempt to mirror or replicate historic features, new structures should not be so dissimilar as to distract from or diminish the historic interpretation of the district.

Contemporary Interpretations of Traditional Designs and Details May be Considered

When applied to a compatible building form, contemporary materials and architectural details can increase energy efficiency and provide visual interest while helping to convey the fact that the building is new.

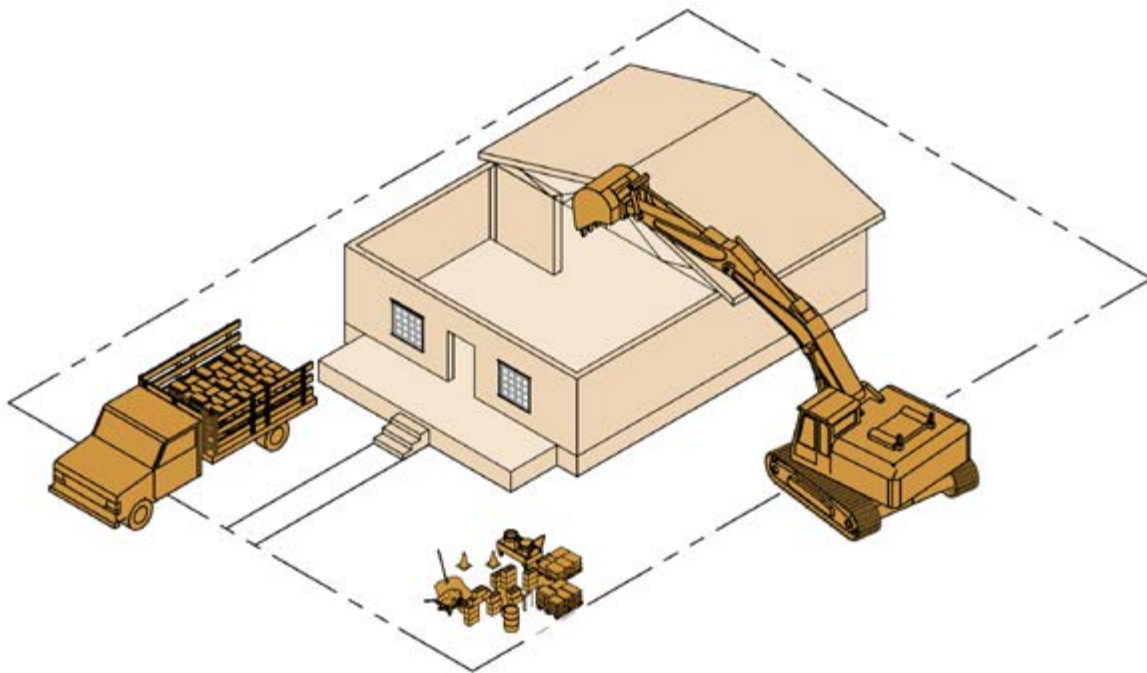

Figure 4.9: *New Construction*

4.6.1 RESIDENTIAL INFILL

Single-lot infill development in the City’s residential historic districts may occur on existing vacant lots, or on lots where a structure has been demolished or relocated. Multiple vacant lots along a historic residential street detract from its visual character by creating a “missing tooth” condition, where

gaps in building placement disrupt the street rhythm. Infilling, or building on these parcels today provides new opportunities for replacement housing as well as opportunities to strengthen the fabric of the districts themselves.

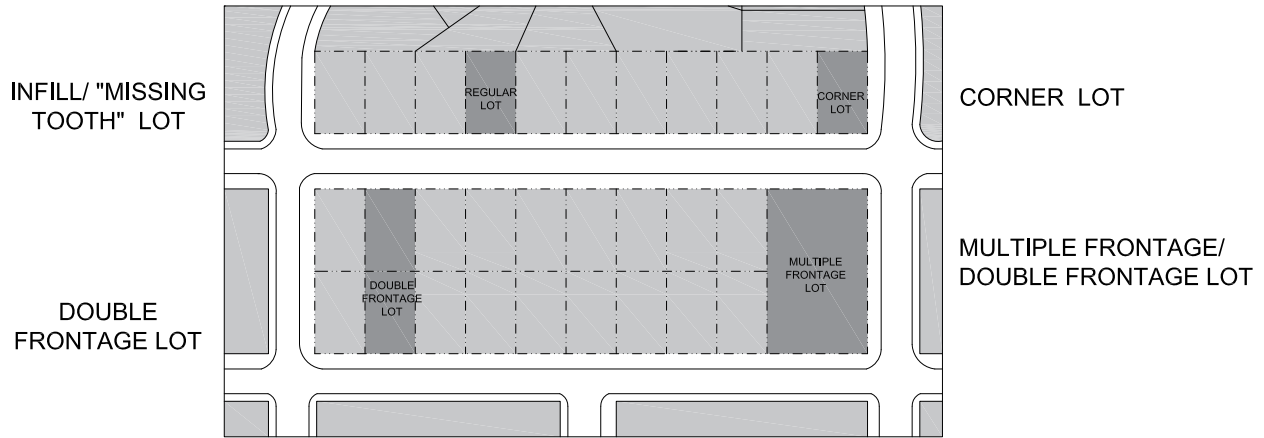

Figure 4.10: Neighborhood Lot Types



Aerial image of the South Florida Avenue corridor showing the existing lot arrangement of Dixieland to the west and South Lake Morton to the east

4.6.2 NEW CONSTRUCTION

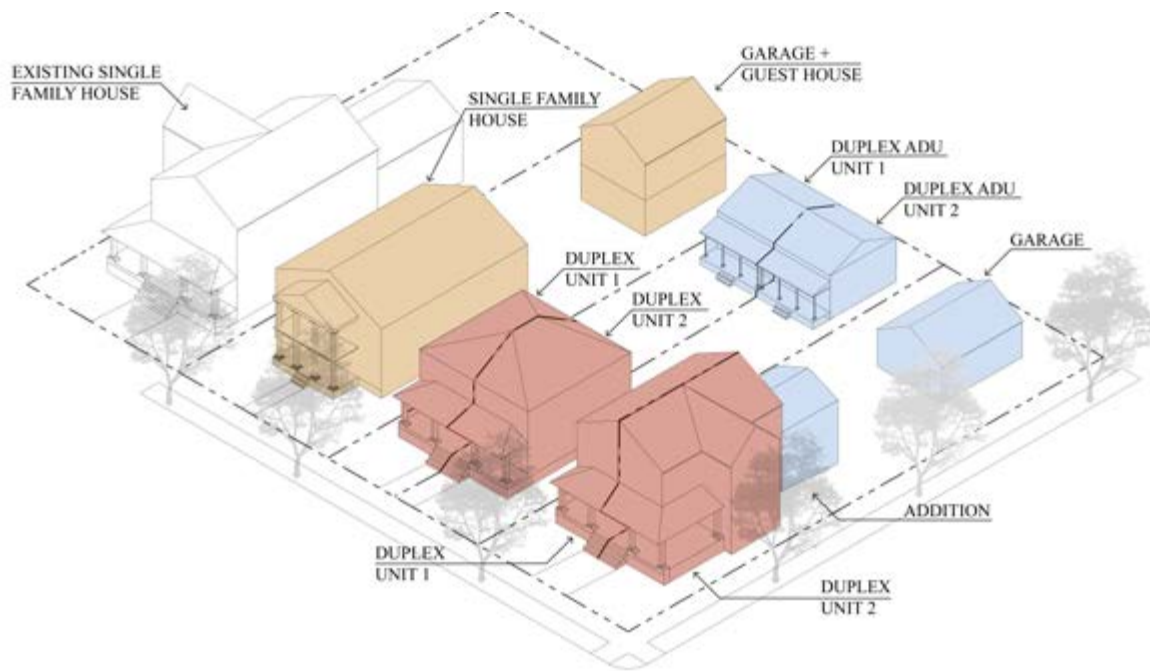

Figure 4.11: Residential Infill Development and New Construction

These guidelines apply to the design of new construction in Lakeland’s historic districts. It is important to realize that while a historic district conveys a certain sense of time and place associated with its history, it also remains dynamic, with alterations to existing structures and construction of new buildings occurring over time.

The Secretary of the Interior’s Standards for the preservation of historic structures are the basis for these guidelines. Although these Standards are oriented toward rehabilitation of existing historic buildings, Standards 2 and 9 apply to new construction in historic districts.

Specifically that:

- “New additions, exterior alterations, or related new construction shall not destroy historic materials that characterize the property”; and
- “The new work shall be differentiated from the old and shall be compatible with the massing,

size, scale, and architectural features to protect the historic integrity of the property and its environment.”

While new construction may replicate historical architectural styles and/or building types found in Lakeland, this is not a requirement for new buildings. The scale, massing, and proportion of building form and features for new infill structures should relate to the fundamental characteristics of the district while also conveying the stylistic trends of today. It may do so by drawing upon traditional building methods that define the character of an individual historic district. Additional features upon which to draw include the way in which a building is located on its site, the manner in which it relates to the street and its basic mass, form and materials. When these design variables are arranged in a fashion similar to those traditionally seen in the area, visual compatibility results.

4.6.3 SINGLE LOT INFILL

Single lot residential infill compatibility in the City’s historic neighborhoods is achieved using a number of basic design criteria, such as building setbacks – the distance the house sits back from the property lines; massing or form – the general size and shape of a house relative to adjacent structures; orientation – the street-facing direction of the primary house façade and entrance; and primary façade

proportions – the general organizational composition of the street-facing or primary house façade. These are some the most recognizable physical design aspects in all of the City’s historic residential neighborhoods, and contribute to the order and established community design framework that these Guidelines seek to protect and enhance.

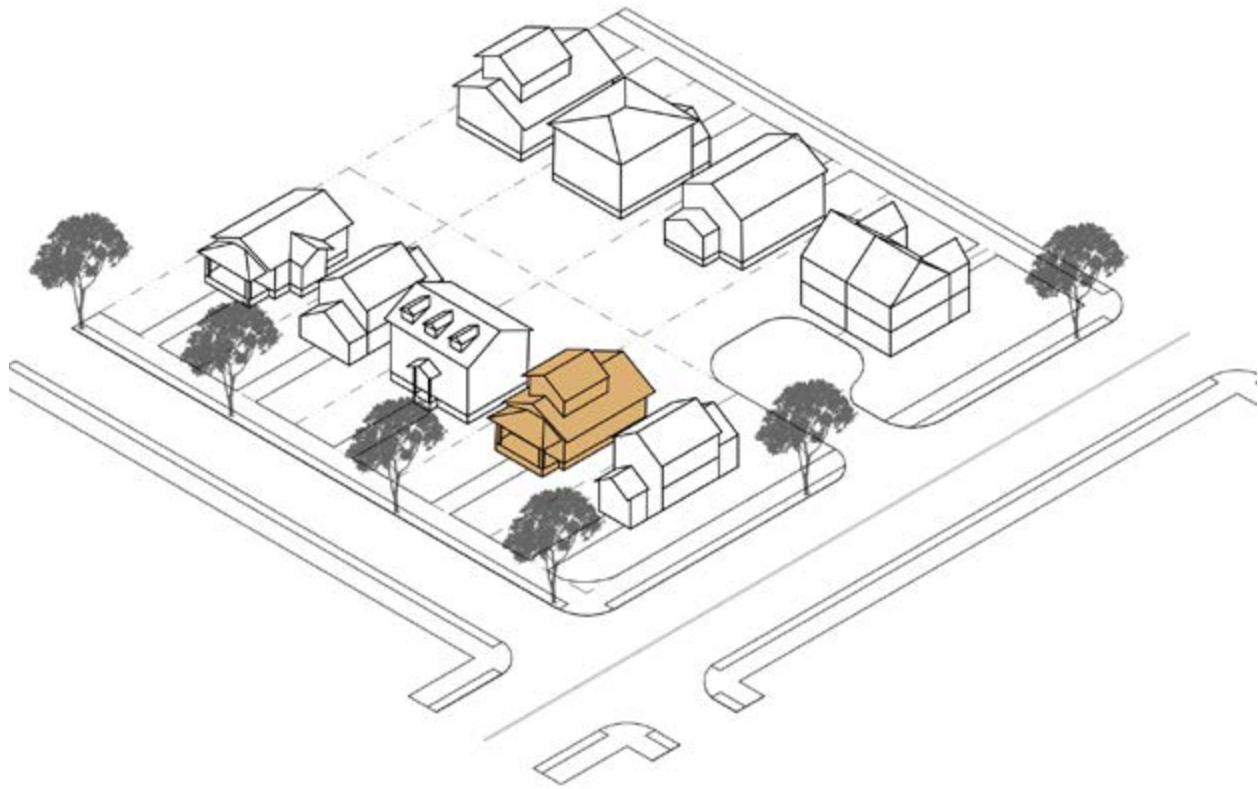

Figure 4.12: Single-Family Infill



4.6.4 SETBACKS

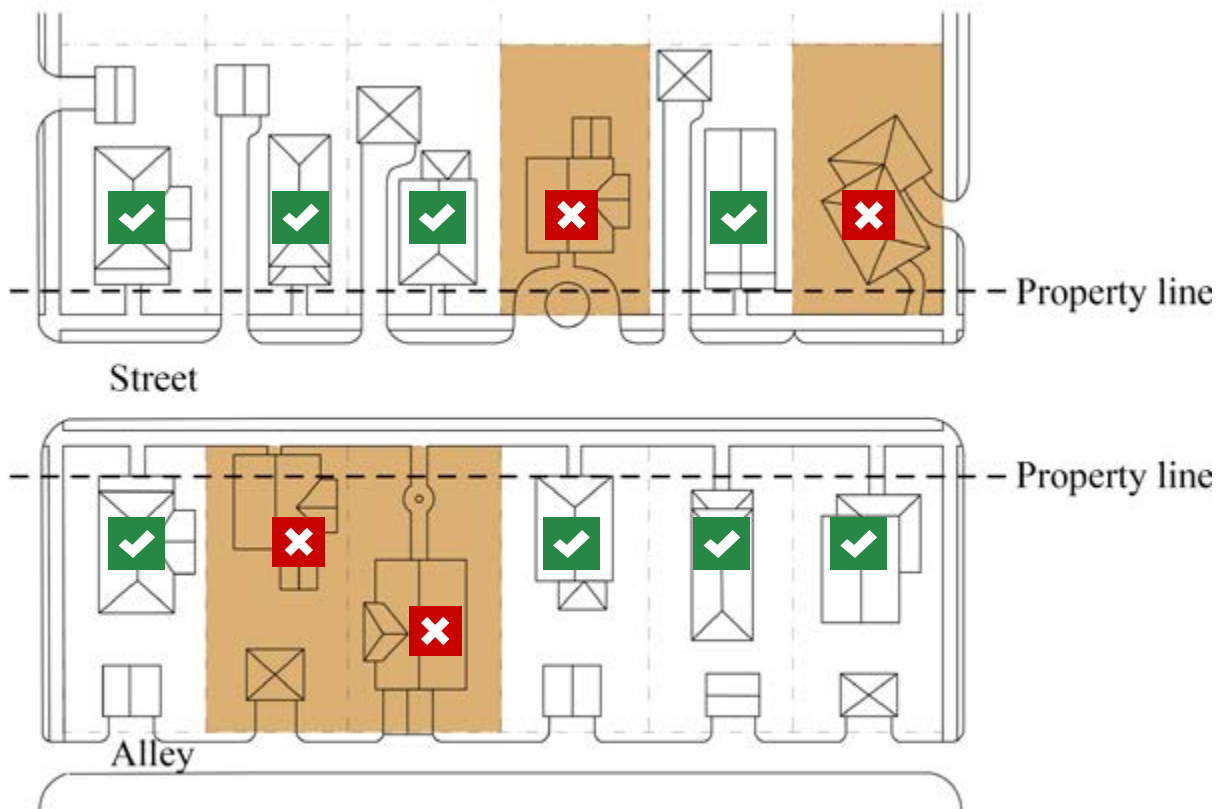

Figure 4.13: Building Setbacks Should be Consistent along a Neighborhood Street.

Lakeland’s residential historic neighborhoods exhibit a defined spatial order and siting of buildings on their respective lots. Article 3 of the City’s Land Development Code establishes building setback criteria for all new buildings. These standards identify minimum distances between the house and its surrounding property lines. In historic districts, the front setback is of primary importance relative to infill development. The consistent setback pattern established by existing historic structures along the street creates a framework for the placement of new infill buildings. These setbacks also determine the location of a house’s primary building façade and its

relationship to the street, as well as the orientation of its main entrance.

Structures that reflect existing setback patterns are better integrated into the established order of the street. Although setbacks may vary in certain locations, infill structures should reflect the front setback distances of existing houses on either side. Where setbacks of adjacent structures are the same on both sides, the front setback for an infill structure should be the same. Where they vary on either side, the setback for infill structures should be an average of the two adjacent structures.

Guidelines for Residential Setbacks



ACCEPTABLE

- Single and multi-family structures (i.e. single family attached dwellings, townhouses and small apartment buildings) that adhere to established setback distances on adjacent lots.
- Where setbacks are different on either side of the subject property, the setback should be an average or halfway between the two.
- Alignment of porches, projecting bays, entryways and other façade elements of infill development with adjacent historic structures.
- Principal infill structures and accessory structures that adhere to all setback standards (i.e. minimum front, side and rear yard setback distances) indicated in [Subsections 3.4 and 4.3](#) of the City's Land Development Code.



NOT ACCEPTABLE

- Front setbacks that deviate from the established setback distances along the street.
- Excessively deep or shallow front setbacks that create contrasting development patterns.
- Side and rear setbacks that do not maintain minimum space between buildings.
- Infill structures that do not maintain the building-to-lot proportions present on adjacent properties.
- Infill structures that do not respect existing setbacks in a historic district.
- Infill buildings that exceed the maximum permitted lot coverage ratios established by the City's Land Development Code.



4.6.5 ORIENTATION

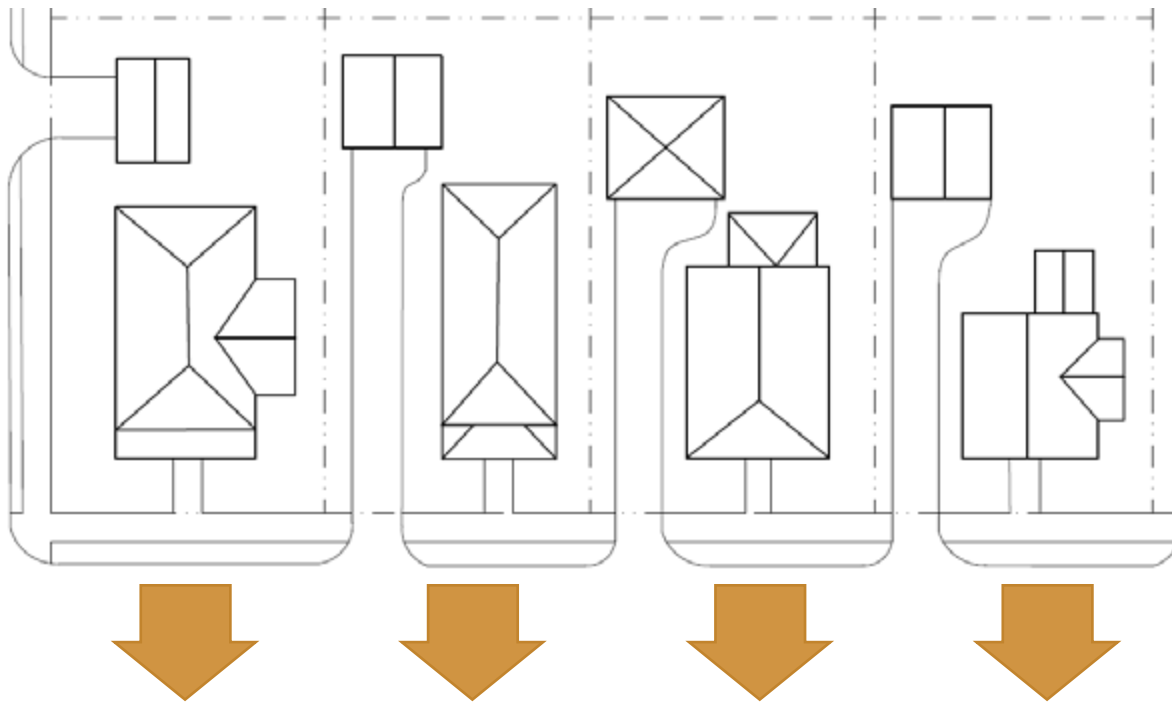

Figure 4.14: *Street-Facing House Orientation*

Landmark buildings and most buildings in the City’s historic districts have an easily recognizable orientation to the primary street. With their front facades and entrances oriented directly towards the street, each house contributes to the established community design, character and physical identity. Regardless of house type, style, or lot configuration, the uniformity of the neighborhood block face

in all of the City’s historic neighborhoods is defined by structures with their principal facades, porches and main entrances oriented towards the street. This characteristic is often heightened in historic neighborhoods because it establishes a precedent for all infill development. Maintaining this orientation further strengthens the character of each historic district.



Guidelines for Residential Orientation



ACCEPTABLE

- Single and multi-family structures (i.e. single family attached dwellings, townhouses and small apartment buildings) with front facades and entrances that are oriented to the street.
- Single-family and multi-family structures on corner parcels with secondary orientation on a side street.
- Building entrances, porches and landings with orientations that are consistent other historic structures along the street.



NOT ACCEPTABLE

- Single-family and multi-family structures with primary facades and entrances that are oriented at an angle or away from the street.
- Infill structures with no entry along the street.



4.6.6 MASSING AND SCALE

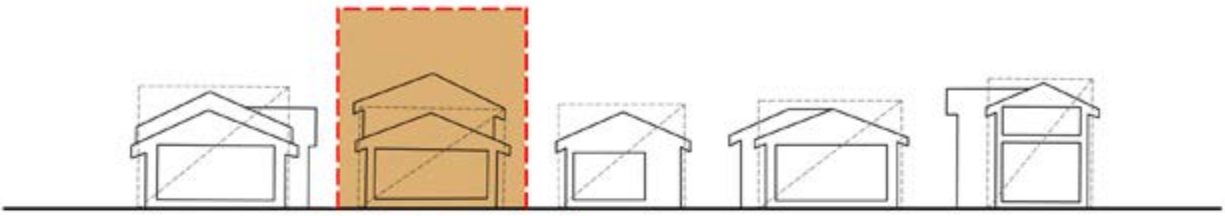

 **ACCEPTABLE MASSING AND SCALE**

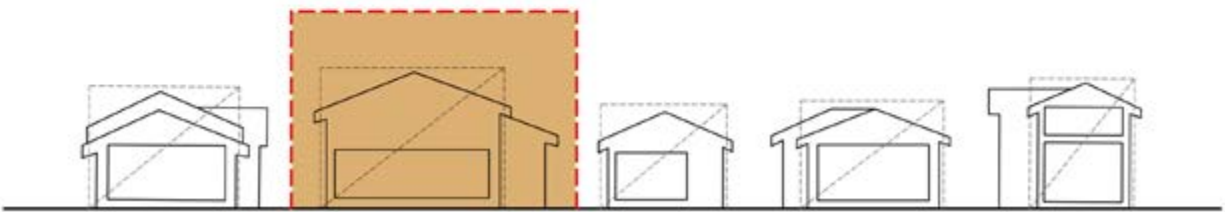

 **NOT ACCEPTABLE MASSING AND SCALE**

Figure 4.15: Massing and Scale Along the Street

The massing or scale of a building is one of its basic physical characteristics. This condition is often understood through perceptions of its height, width, volume, or overall size. The massing and scale of existing historic district buildings are comprised of basic geometric shapes that are associated with four distinct features: a rectangular volume for the main body of the house; angled planes for the roof form; small rectangular protrusions for building additions; and the open volume of a front porch. These elements serve as a massing point of reference for infill development in historic districts.

These Guidelines are intended to identify basic design parameters for compatible form and massing of infill structures. They are not intended to restrict the size or design creativity of new structures. Relative to massing and scale, these Guidelines identify two conditions that are used as assessment criteria for determining compatible massing conditions: directional expression and volume distribution.

Directional expression refers to the relationship between the overall height of an infill structure relative to its width, or its vertical and horizontal proportions. Height and width conditions of single-family infill structures are two of the primary physical characteristics that shape perceptions of scale compatibility in historic districts. To minimize contrasts with older structures and not detract from the character of the district, the scale of infill structures must be sensitive to that of adjacent houses.

Volume distribution refers to the manner in which the various massing components are arranged or designed within a single-family structure. This includes the basic form of the structure, its roof shape and the general silhouette created by different room or other massing extensions. Although infill structures may exhibit contemporary massing proportions, they should incorporate design strategies for the distributing of massing volumes to achieve compatible conditions with existing houses along the block face.

Guidelines for Massing and Scale



ACCEPTABLE

- Infill structures with compatible massing and scale conditions with adjacent structures on the same block face.
- Structures that utilize design strategies to reduce the apparent scale of the primary façade to blend in with adjacent structures.
- Corner infill structures that acknowledge prominent locations with appropriate transitional or other massing gestures.
- Infill structures that are elevated a minimum of 21 inches above grade to promote visual interest, privacy and consistent building height zones along the street.
- The scale (height-to-width ratio) of an infill structure’s street-facing facade that is compatible with and maintains massing proportions established by adjacent historic structures.
- The height of walls, cornices and roofs and chimney on new infill structures that are compatible with existing building heights.
- Infill structures that are no more than one story higher or lower than adjacent buildings.
- Infill structures in the Garden District, which is included in the East Lake Morton Historic District, that are positioned on the “build-to” line instead of a minimum front yard setback.
- All principal new buildings must have front porches or terraces that may extend toward the street from the “build-to” line.



NOT ACCEPTABLE

- Massing features on infill structures that are too dissimilar with or exceed the scale of adjacent historic structures.
- Infill structures configured with general massing proportions that create contrasting conditions with adjacent historic structures.
- Infill building footprints with a higher percentage of site coverage (“land-crowding”) than adjacent historic structures.
- Absolute or total height of infill structures that are in excess of one story of the tallest historic structure on the street or block.
- Infill structures that are built with at-grade foundations.



4.6.7 FACADE PROPORTIONS FOR INFILL DEVELOPMENT



QUEEN ANNE



COLONIAL REVIVAL



FRAME VERNACULAR



RANCH



BUNGALOW



FOUR SQUARE

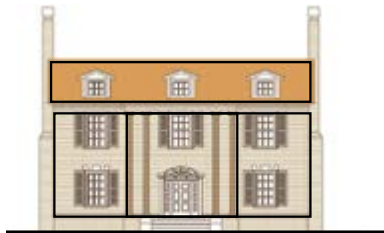

NEOCLASSICAL



MEDITERRANEAN REVIVAL



GREEK REVIVAL



DUTCH COLONIAL

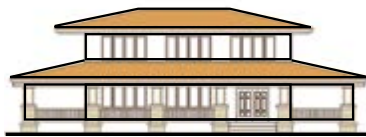

PRAIRIE



TUDOR

Figure 4.16: Façade Proportions of Different House Styles

All houses in the City’s historic neighborhoods exhibit architectural features that define their stylistic character. Although they vary from structure to structure, these architectural features play a major role in influencing the visual impact of a historic block face. The diverse architectural composition of historic house facades establishes a precedent for the design of infill structures, as well as the general appearance of the historic districts.

The recognizable qualities of façade compositions, their geometry, proportions, porch size and configuration, window area, entry placement, vertical bay definition, roof profiles and wall recesses are all elements of the visual expression of a historic block face. Façade proportions and features of the different residential architectural styles in Lakeland’s historic neighborhoods should serve as a point of reference for assessing the compatibility of new infill development. Façade proportions of historic structures are typically defined by a combination of foundation height, porch features, floor-to-ceiling heights, roof pitch and form, and fenestration patterns. Together, they break up the perceived volume

of individual houses when viewed from the street and they contribute to the aesthetic character of the entire historic block face.

These Guidelines promote infill development with basic façade proportions and massing compositions that are compatible with adjacent historic houses. This can be achieved when the façade proportions of infill structures relate to the general profiles, silhouettes or geometries on historic houses in a “diagrammatic” manner.

“Diagrammatic compatibility” refers to how the general outline or profile of an infill building relates to adjacent historic buildings on the same block when viewed from the street. This condition does not require a replication of existing historic house forms, but rather a more flexible way to introduce new structures on historic streets. Using this approach, new infill development can achieve an acceptable level of compatibility with façade compositions and other massing gestures that are sensitive to façade patterns that already exist.

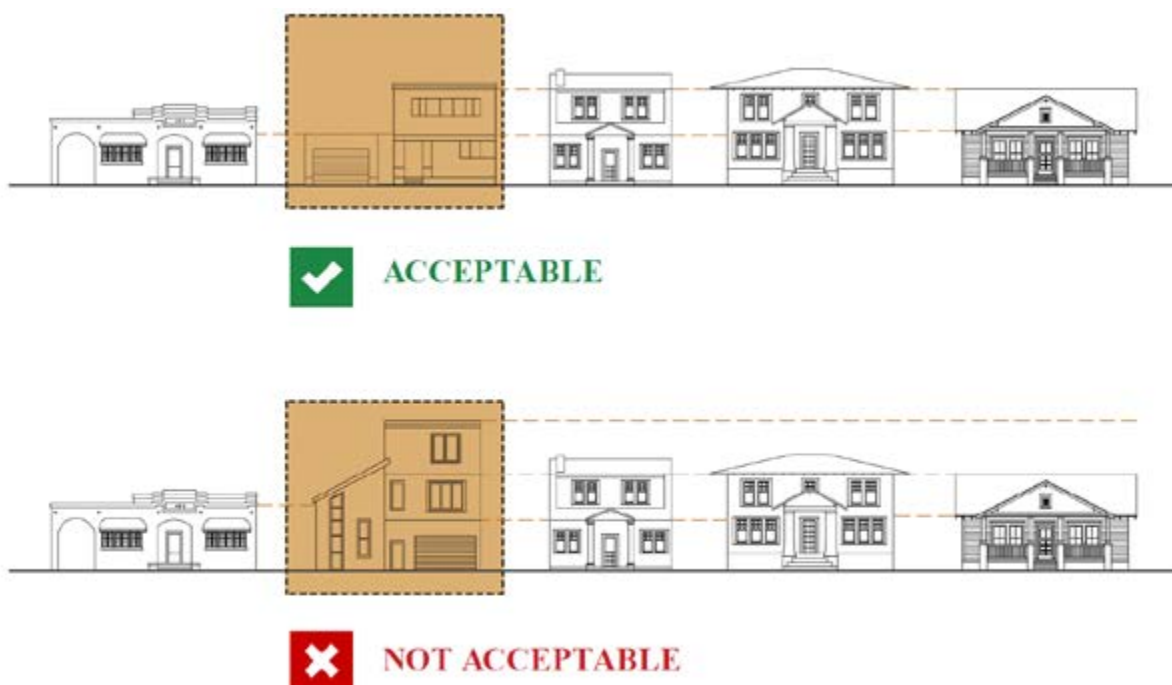

Figure 4.17: Diagrammatic Compatibility

Guidelines for Compatible Façade Proportions



ACCEPTABLE

- Single-family infill structures with façade proportions that are sensitive to those on adjacent historic structures.
- Infill structures that exhibit a minimum level of “diagrammatic compatibility” with historic houses along the street.
- Façade compositions on infill structures that use design strategies to relate to historic façade patterns.



NOT ACCEPTABLE

- Facades of infill structures should not incorporate excessive window area or sizes that are not compatible with adjacent historic structures.
- Façade proportions on infill should not be out of scale or in stark contrast with those of adjacent historic houses.
- Facades of infill structures should not incorporate large expanses of blank wall space.



4.6.8 COMPATIBLE FACADE DETAILS FOR SINGLE AND MULTI-FAMILY INFILL STRUCTURES

These guidelines apply to the design of additions, alterations, and new construction of single-family and smaller multifamily structures in Lakeland’s historic districts. It is important to realize that while a historic district conveys a certain sense of time and place associated with its history, it also remains dynamic, with alterations to existing structures and construction of new buildings occurring over time.

The Secretary of the Interior’s Standards for the preservation of historic structures are the basis for these guidelines. Although these Standards are oriented toward rehabilitation of existing historic buildings, Standards 2 and 9 apply to new construction in historic districts. Specifically that:

- “New additions, exterior alterations, or related new construction shall not destroy historic materials that characterize the property”; and
- “The new work shall be differentiated from the old and shall be compatible with the massing, size, scale, and architectural features to protect the historic integrity of the property and its environment.”

Rather than imitating older buildings, a new design should relate to the fundamental characteristics of the district while also conveying the stylistic trends of today. It may do so by drawing upon basic ways of building that defines the character of an individual historic district. Such features upon which to draw include the way in which a building is located on its site, the manner in which it relates to the street

and its basic mass, form and materials. When these design variables are arranged in a fashion similar to those traditionally seen in the area, visual compatibility results.

In addition to site development standards, new infill development that seeks to blend in better with existing historic contexts should exhibit architectural details that are appropriate to the style of the structure. Where traditional features are used on new infill structures, they should be incorporated in a manner that is architecturally correct and respectful of similar features on historic structures. While new structures are not required to mimic existing buildings, they should not exhibit features that are “historically-caricaturist” in expression either. These features are evidence of the craftsmanship incorporated into many of the City’s original historic houses and are some of their major character-defining elements. While it may not be preferable or feasible to replicate these features, new infill structures based on traditional designs should incorporate appropriate architectural details that acknowledge the local historic context. In order to accomplish this, it is essential that new infill structures use construction methods and materials that achieve a discernible level of compatibility with adjacent historic structures. The following are some of the most important architectural details and features on new infill structures that homeowners, architects and contractors should consider during design and construction.



4.6.9 ARRANGEMENT OF PORCH COLUMNS AND WALL OPENINGS

The placement of porch columns and the arrangement of a structure's fenestration elements are major and stylistic and design characteristics. In historic districts, most historic house styles follow a rational order or rhythm for the placement of these features. The different ways these elements are composed indicates a precedent pattern of regularly spaced columns with windows and door openings centered in between. This results in a regular window bay spacing in the structure's principal façade.

The way columns are placed on a porch, fenestration patterns of windows and doors and other façade features defines the structure's perceived rhythm and order from the street. This layered condition, which often defines symmetrical facade conditions, is also one of the most prominent visual compositions that expresses a unique architectural style. New infill structures and porch additions should interpret these as precedent conditions and reflect porch column and fenestration patterns that work in conjunction with each other as major façade compositions.



Figure 4.18: Regular Arrangement of Porch Columns and Wall Openings

Guidelines for Porch Columns and Wall Openings

✓ ACCEPTABLE

- Porch column and fenestration patterns that are coordinated to reflect a discernible order or regular window-bay definition.



Appropriate Column Placement Defining Window Bays

✗ NOT ACCEPTABLE

- Porch and wall openings that appear to be randomly placed, resulting in an irregular or diminished façade composition.
- Porches designs that do not create a discernible window bay spacing or rhythm along the front façade.



Inappropriate Column Placement: No Window Bay definition

4.6.10 PORCH COLUMNS AND BEAM DETAILS

One of the most visible features of a historic house is its porch and the many features that are part of this entryway and outdoor space assemblage. Porch columns have traditionally been one of the most diverse features of the porch. Columns can be single structural elements, or groupings of smaller column features. For single columns it is important for the

face of the column to be flush with the face of the beam above – not a thin member that is centered or on the edge of the column top. This is a design detail that gives the impression of appropriate-sized vertical and horizontal structural members for the porch itself.

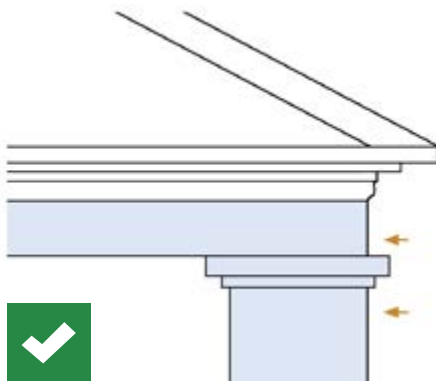

Porch Column to Beam Detail

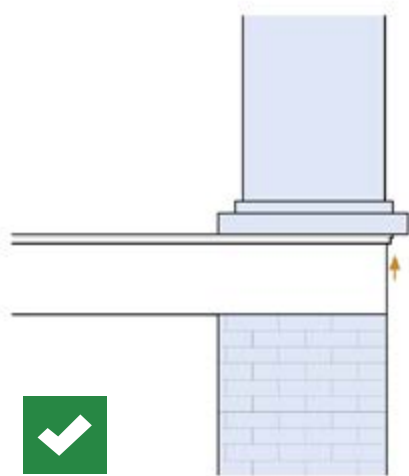
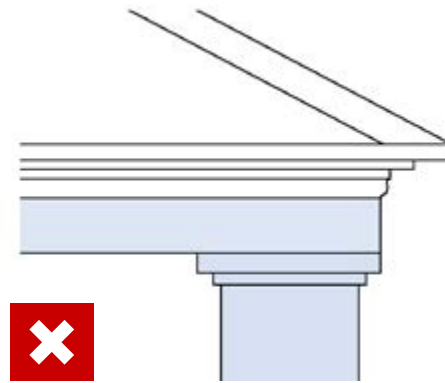

Porch Column to Floor Detail

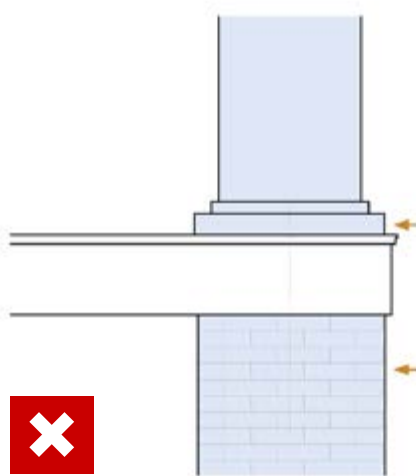

Figure 4.19: Acceptable and Not Acceptable Column Details

Guidelines for Porch Column to Beam Details on Infill Structures

✓ ACCEPTABLE

- Porch column faces that are flush with the face of the beam or horizontal structural member above them.
- Porch columns that are appropriately scaled relative to the size of the beam above them.



Appropriate Column and Beam Details

✗ NOT ACCEPTABLE

- Beams that are either too narrow or too wide and not aligned with the face of the column below.
- Columns that are disproportionately scaled.



Inappropriate Porch Columns and Beam Details

4.6.11 WINDOW CONFIGURATIONS

Windows are also some of the most character and style-defining detail features of structures in the different historic districts. For new infill structures to better achieve compatible conditions with other structures in the district, the design, configuration, materials and casings are features that should be carefully coordinated the structure's design or basic architectural style. Although there are numerous windows options for new infill structures, those that use traditional architectural features should incorporate appropriate window details. This includes window proportions and configurations, materials and

trim features. Windows should be configured vertically or square with height to width proportions ranging from 1:1 to 3:1. These proportions are often based on the human body and reflect the window patterns of adjacent historic structures. The many window options available today are primarily constructed of wood, clad-wood or a synthetic material such as vinyl. Regardless of materials used, windows in new infill structures that use traditional design features, should be indiscernible from wood windows at about four feet away.



Figure 4.20: Acceptable Window Configurations

Guidelines for Window Configurations on Infill Structures

✓ ACCEPTABLE

- Windows that have vertical or square proportions.
- Windows based on traditional types with the correct number of panes.
- Structures that incorporate window designs as a coordinated ensemble.
- Windows constructed of wood, wood cladding or a synthetic material that looks like a traditional wood window.
- When a simulated-lite appearance is used, the muntins (grid/grille) should be mounted to the exterior glass.



Appropriate Vertical Window Configurations

✗ NOT ACCEPTABLE

- Windows in new infill structures that use horizontal proportions, or some other inappropriate configuration.
- Infill structures that use a variety of different window types on different facades.
- Simulated-lite appearance with "sandwiched" muntins without an exterior-mounted grid/grille.



Inappropriate Window Configurations

4.6.12 EAVES AND RETURNS

Eave details on new infill structures are important architectural features that should exhibit proper detailing. Eaves and eave returns are visual details that particularly noticeable on all roof types of infill structures. Roof edges, the undersides of overhangs and eave returns all work together as an architectural assemblage that terminates the expanse of the roof regardless of house style.

Eave returns are also prominent visual details on some house styles. Eave returns that create a subtle termination at the lower corner of the roof's gable

end are considered a better detail for this condition, rather than the “poor man’s version” that exaggerates the eave return with a vertical bird box or slanted “pork chop – shaped” closure feature. Where continuous eave returns are used, they create pediments by completing the triangular roof profile. This detail should not be exaggerated to call attention to the gable end when it’s on the front façade. Other components of eave assemblages on infill structures often include brackets and other ornamental trim. These features call further attention to the gable end of the structure, particularly on street-facing facades.

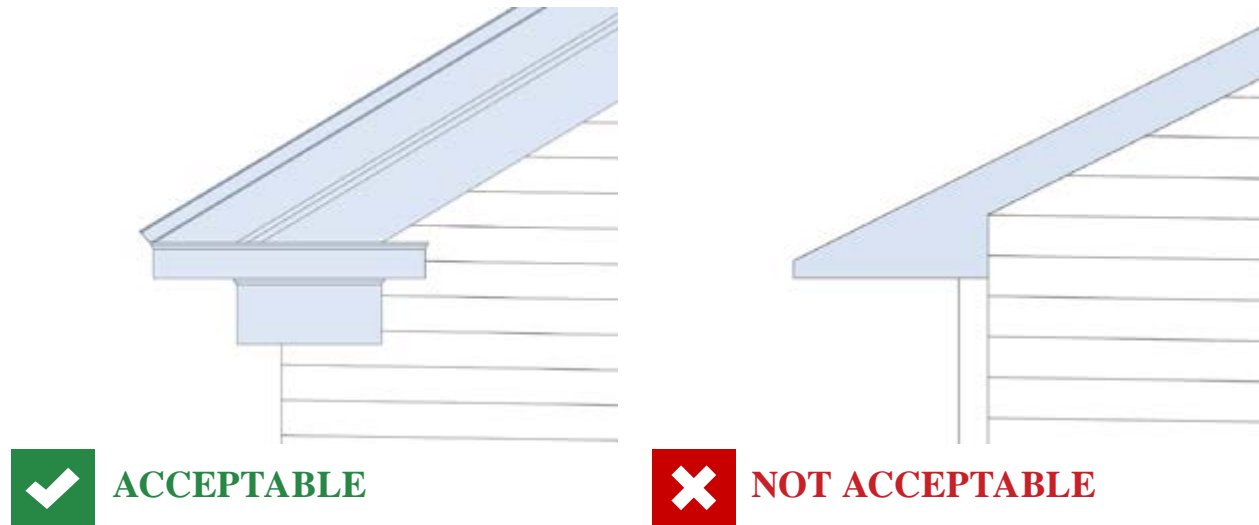

Figure 4.21: Acceptable and Not Acceptable Eave Brackets

Guidelines for Eaves and Returns on Infill Structures



ACCEPTABLE

- Eaves details that are constructed or crafted to complement the style of the infill structure.
- Eaves that use properly located and sized brackets and gable end trim.



Appropriate Eaves Returns and Eave Brackets



NOT ACCEPTABLE

- Eaves with exaggerated returns or those that use vertical closures.
- Eaves with overstated trim details that are incompatible with the style of the house.

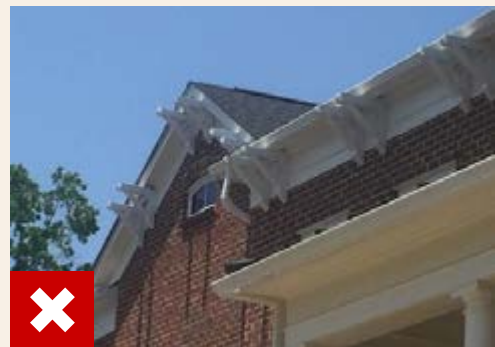

Inappropriate Eaves Returns and Eave Brackets

4.7 MULTI-FAMILY INFILL

Lakeland’s residential historic districts are primarily comprised of single-family houses. In addition to single-family houses, in some districts there exist several types of low-density multi-family structures, such as duplexes, triplexes, quadplexes, and small apartment buildings. These structures are generally compatible in scale with adjacent historic homes and do not create major inconsistencies with the traditional development pattern on their respective streets. While few of these structures are historic in nature, many have had a presence in the historic districts since the 1940s.

Many of the properties in the residential historic districts are zoned RA-3, RA-4, MF-12, or MF-22. These designations allow for different types of low to medium density multi-family building types that meet Land Development Code site development criteria. Low to medium density multi-family infill structures can be designed to benefit historic districts in a number of ways. When implemented to reflect best practices in preservation planning and sustainable community design, multi-family structures can: contribute to the diversity of historic districts; create opportunities for affordable and workforce housing; expand the range of housing options in general; and complement the overall form and character of

a historic street. Appropriately-scaled, multi-family infill housing that is compatible with the massing, form, and character of established historic neighborhoods is encouraged. In many instances, this type of infill is helping to stabilize older neighborhoods and strengthening their property values as well. These Guidelines promote innovative design strategies for infill development that add value and complement existing historic districts. Multi-family structures that are appropriate for these areas are often referred to as the “Missing Middle.” These are low to medium density multi-family building types, such as single family attached, quadplexes, townhouses, and small apartment buildings, that represent the residential component of neighborhood-scale, mixed-use buildings. These structures were common historically in established historic neighborhoods, but today are all but missing. Many cities are modifying zoning and land development regulations to allow these structures to address issues ranging from affordability, sustainability, changes in demographics and family structure, as well as local economic development. Except for two to four unit buildings, larger or higher density multi-family structures are best suited for infill sites located on corners or at the end of a block.



4.7.1 DUPLEXES

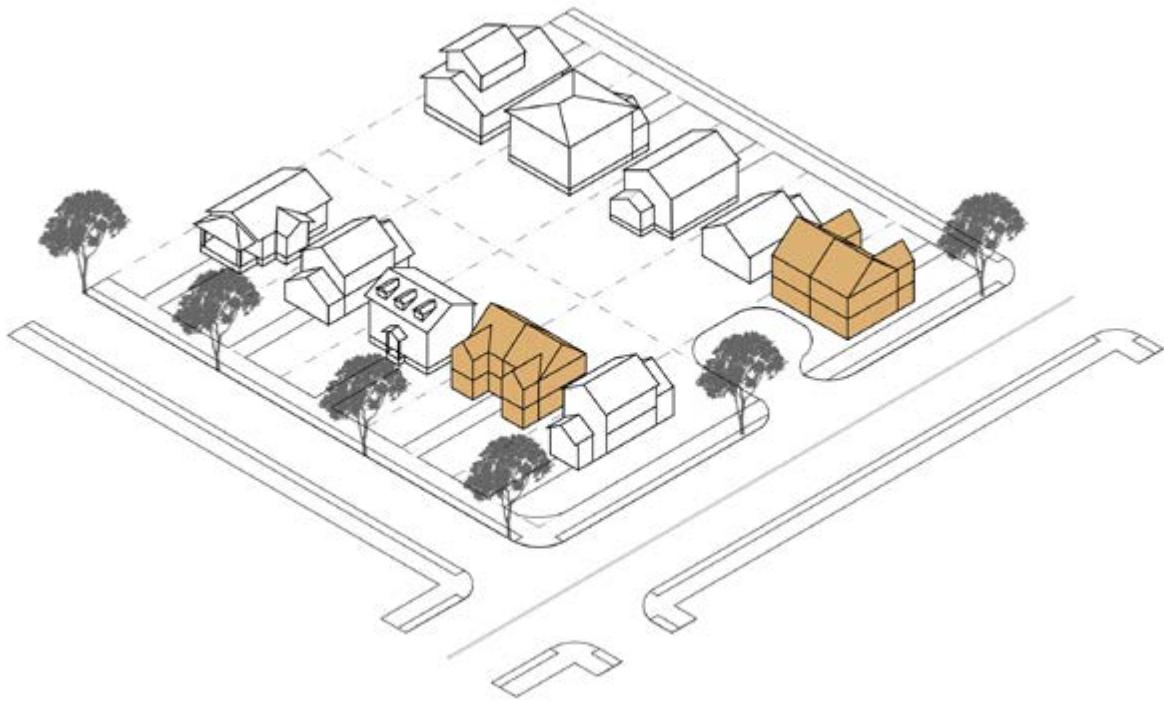

Figure 4.22: Duplex Infill Development

The smallest multi-family structure appropriate for infill in historic districts is the duplex or two-family building type. This multi-family structure is configured with two individual dwelling units. In Lakeland’s residential historic districts, single-story duplexes are no longer permitted. The single family attached special building type (LDC Table 3.4-11) is permitted by Conditional Use in RA-3 and RA-4 zoning districts.

The single family attached dwelling is a building containing a one-family dwelling on its own lot or parcel attached by common vertical walls to another one-family dwelling located on its own lot or parcel. Each single-family attached dwelling unit has one or more entrances on the ground floor and at least 40 percent of its living area on the ground floor.

This building type is one of the “Missing Middle” multi-family structures that can be designed to be compatible with historic neighborhoods but is often non-existent.

The side-by-side configuration can be configured to better blend in with the massing proportions of adjacent single-family houses. This type of multi-family structure is often used for infill development on smaller parcels with at least 50 feet of street frontage. For smaller parcels, the number of required on-site parking spaces for duplexes often requires a driveway or parking apron at the street that is wider than that of adjacent historic structures. This condition diminishes the street-facing character of the duplex structure and limits opportunities for front yards similar to adjacent structures.

In addition to duplexes, other smaller multi-family infill structures such as triplexes (i.e. three-unit structures) and quadplexes (four-unit structures) are also appropriate for infill in the City’s residential historic districts. These types of multi-family structures can be designed to blend in with the established single-family contexts. The scale of these

structures is often no larger than a two-story house and can be designed with compatible massing proportions. While they can provide housing options in the districts, they do require a certain number of on-site parking spaces per unit. As such, triplexes and quadplexes are better suited for larger lots.

**Single-story duplexes are no longer permitted in the residential historic districts where property is zoned RA-1 to 4. A single family*

attached dwelling may be permitted with a Conditional Use in the RA-3 and RA-4 zoning districts.



Guidelines for Duplex Infill Development



ACCEPTABLE

- Duplex or single family attached dwellings that reflect the scale and massing of adjacent historic houses.
- Duplex structures that are configured to blend in with the order and rhythm of the street.
- Duplex structures with primary entrance features oriented to the street.
- Duplex structures with parking placed behind the structure.



NOT ACCEPTABLE

- Infill duplex structures constructed on parcels with less than 50 feet of street frontage.
- Duplex structures with excessively wide parking aprons or driveways facing the street.
- Duplex structures with parking in the front yard.

4.7.2 TOWNHOUSES

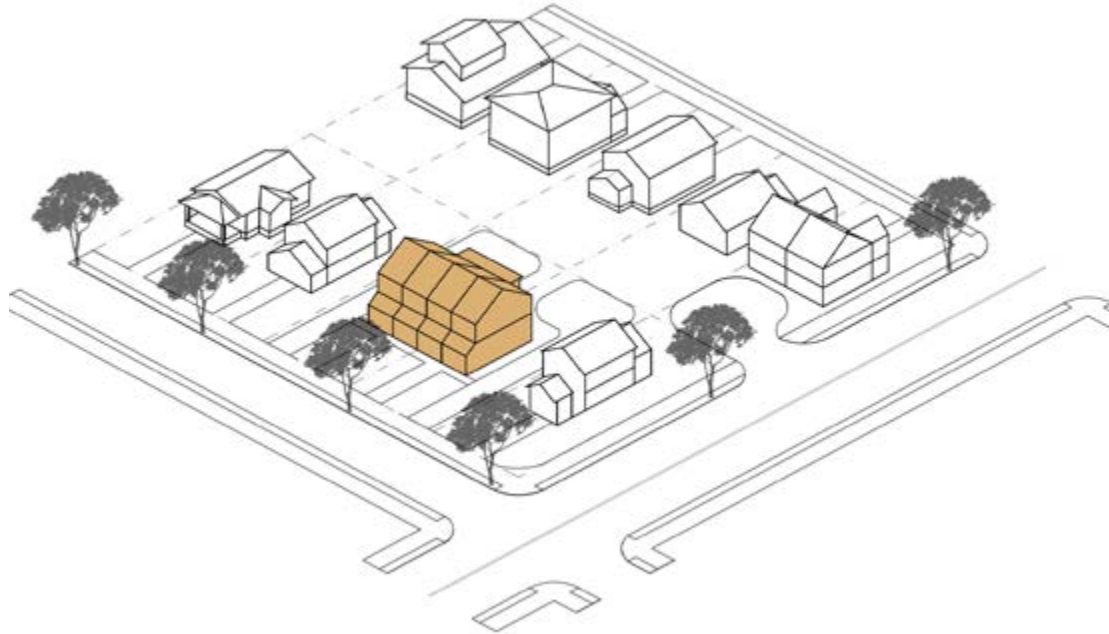

Figure 4.23: Townhouse Infill Development

Another type of multi-family structure appropriate for infill in historic districts is the townhouse. This building type is usually configured with side-by-side fully attached single-family dwelling units and often serves as a transitional building type between single-family neighborhoods and commercial areas, or a longer block face along a busy street. Infill townhouses usually incorporate three or more vertically oriented, two-story dwelling units. Each unit in a townhouse building has a separate main entrance that is typically oriented directly towards the street.

This multi-family building type has the greatest flexibility among lower density residential infill structures because of its vertical orientation and modular

side-by-side replication. This building type can be configured to respond to existing conditions on a block with historic houses by varying its height and massing proportions to achieve a better locational fit with the local context. While this building type is typically organized as individual dwelling units, it can also be configured with individual floor-through units on each level. Townhouse structures with up to four single-family dwelling units are appropriate for infill sites along a block face with historic single-family houses. The scale, massing proportions and diagrammatic silhouette of this size infill structure can be configured to blend in with adjacent historic structures. Townhouse structures with more than four units should be located on a corner parcel.



Guidelines for Townhouse Infill Development



ACCEPTABLE

- Townhouse structures located along a historic block face with up to four units.
- Townhouse structures with five or more dwelling units located on corner parcels or at the end of a block.
- Façades of townhouse structures in historic districts with massing articulations such as window bays, projections and recesses.
- Fenestration patterns on townhouse structures with glazing percentages similar to adjacent historic structures.
- Townhouses no more than three stories in height.



NOT ACCEPTABLE

- Townhouse structures that are not aligned with adjacent building setbacks.
- Townhouse structures that are monolithic in scale and massing.
- Townhouses that are more than three stories in height.



4.7.3 APARTMENT BUILDINGS

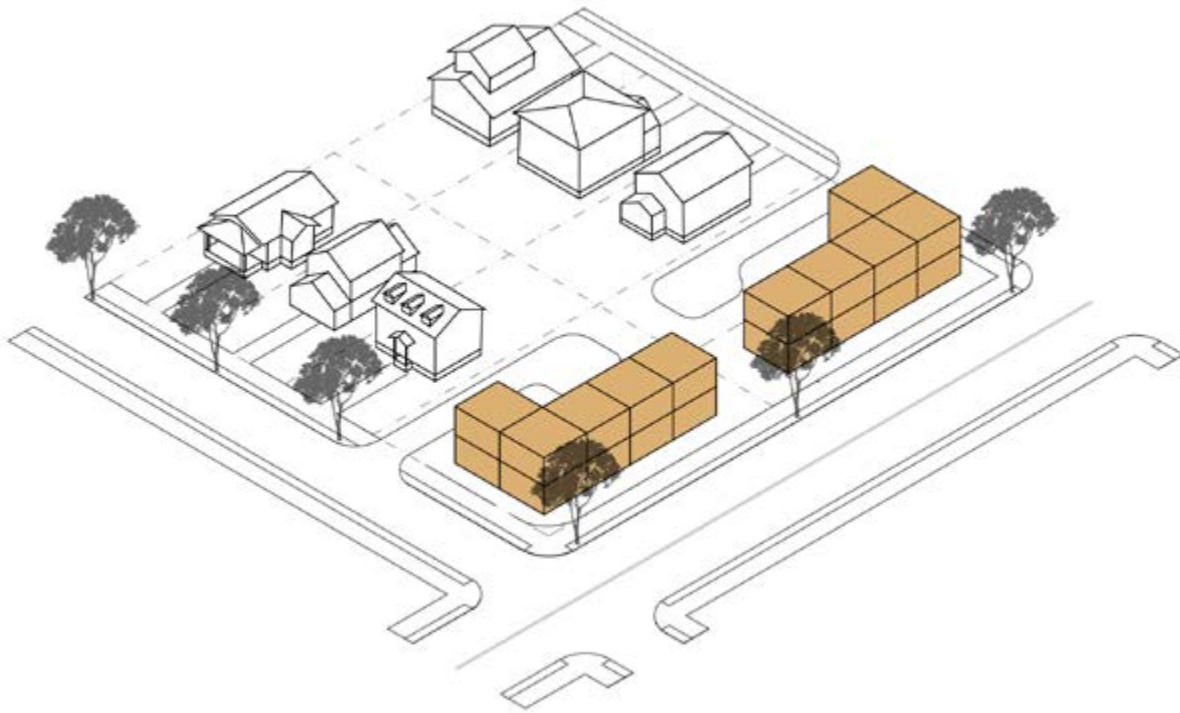

Figure 4.24: Apartment Building Infill Development

Several of the City’s historic districts contain a number of small multi-family apartment buildings of varying densities. Many of these buildings have been a part of their respective neighborhoods for several generations. As multi-family buildings, they vary in density, yet are not completely out of scale with adjacent single-family houses. Today, several districts with these buildings are zoned MF-12 and MF-22 or Multi-Family-12 or 22 dwelling units per acre. This zoning designation allows multi-family infill buildings of modest scale to be introduced as infill in certain historic context.

Neighborhood-scale apartment buildings are typically two to two-and-a-half stories in height and occupy several parcels. As an infill structure, this is the largest of the “Missing Middle” multi-family building type appropriate for historic districts. Although the number of units in this building type and height of a building are controlled by the Land Development Code, this building type should

incorporate a number of massing transitions and other architectural references to adjacent buildings along the street. At this scale, infill apartment buildings are better suited situated at the edge of a historic district or block, or at a broader intersection.

Neighborhood-scale apartment buildings can vary in size. However, all or portions of their massing must be configured to relate to the scale of adjacent historic houses. The scale, height and orientation of street-facing facades of this building type are the main features that determine their compatibility in historic neighborhoods. Apartment buildings with long, uninterrupted facades interrupts the visual order of the street and may detract from the general character of the area. Design strategies such as façade articulations, projecting and recessed bays, height transitions and multiple ground floor access points along the street should be used for this building type to better fit into an established neighborhood setting.

Guidelines for Apartment Buildings

ACCEPTABLE

- Infill apartment buildings that are located on corners or at the end of a block.
- Apartment buildings with form and massing proportions that are compatible with adjacent historic structures.
- Apartment buildings that incorporate design strategies to diminish their perceived scale along a historic street.
- Parking and vehicular movements for apartment buildings situated entirely on-site and screened from adjacent historic structures.



NOT ACCEPTABLE

- Apartment buildings with long, uninterrupted facades that appear monolithic along a block face.
- Portions of apartment buildings that are directly adjacent to a historic structure that exceed 35 feet in height.
- Infill apartment buildings that block solar access for adjacent historic houses.
- Infill apartment buildings that create adverse visual impacts on adjacent historic structures.



4.7.4 MULTI-USE BUILDINGS

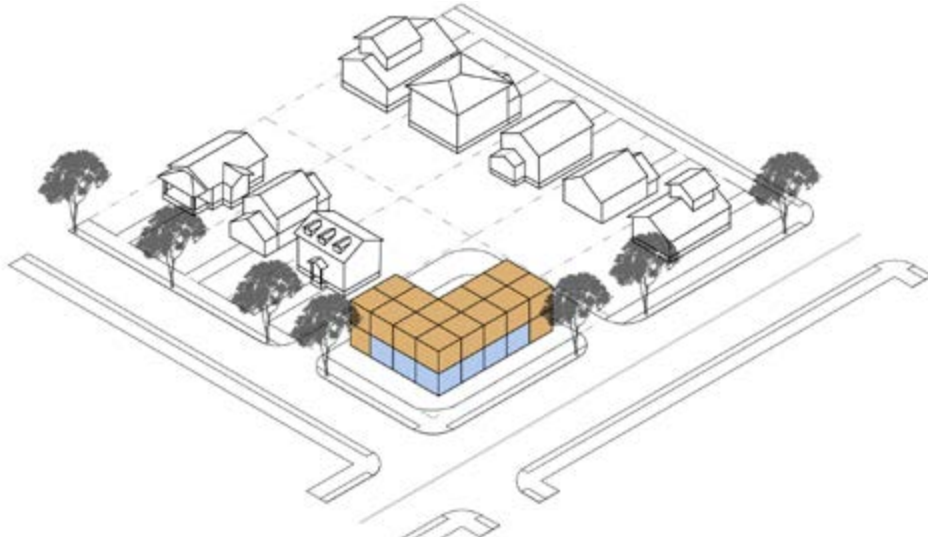

Figure 4.25: Multi-Use Infill Development

Most structures in the City’s historic districts today are single-use, residential dwellings. Building types with multiple uses were an integral component of the neighborhood fabric in many of these areas until the mid-20th century. Since then, these structures are rare as neighborhood-scale commercial uses have dwindled. Today, structures with multiple uses are seeing a resurgence as part of many city’s smart growth and sustainable community design agendas. In the City of Lakeland, multi-use structures are currently concentrated in the Downtown area. Here, it is typically configured as a multi-story commercial building with residential uses above the ground floor.

In residential historic districts, multi-use buildings can be developed on infill sites as stand-alone structures with neighborhood scale ground floor

commercial uses. Variations of multi-use buildings are being built in historic neighborhoods across the country to expand housing options, contribute to district vitality and to provide walkable access to daily goods and services.

Multi-use buildings are typically the largest structures in a residential neighborhood. When used as infill in historic districts, they are best suited for corner locations, along busy streets or on larger (consolidated) parcels at the end of a block. In these locations, multi-use structures can also function as transitions between historic districts and more intense commercial areas. Multi-use buildings are appropriate only for properties with commercial, office, and some higher density multi-family zoning designations located within the Garden District Special Public Interest District.



Guidelines for Multi-Use Infill Development



ACCEPTABLE

- Multi-use infill buildings that are situated on corner parcels, at the end of a block or facing a thoroughfare.
- Multi-use buildings that use design strategies to mitigate scale and massing transitions with adjacent historic structures.



NOT ACCEPTABLE

- Massing configurations of multi-family apartment buildings that create visual or other adverse impacts on adjacent historic houses.
- Commercial components of multi-use infill structures that are oriented towards adjacent residential buildings.
- Parking and service activities associated with commercial components of multi-use buildings that are not properly screened or buffered from adjacent properties.



4.8 ADAPTIVE USE



Most buildings in the City’s historic districts retain the primary residential use for which they were initially built. However, several of these areas have zoning designations that allow uses other than residential. All zoning classifications, residential densities, and permitted uses are regulated by the City’s Land Development Code. Over time, districts that abut commercial areas, are adjacent to busy vehicular thoroughfares, or have edge conditions that are zoned for commercial uses, may have historic houses or other structures that lend themselves to being retrofitted with a different use. This often results in a transition from residential to commercial use. This evolution is commonly referred to as adaptive use – essentially re-using an older structure by adapting a new use to it. While most buildings retain their original primary function over time, the adaptive use process is essentially aimed at re-purposing existing structures that may be vacant or functionally obsolete. Adaptive use projects occur in historic districts for several reasons. In every instance, these projects

should be designed to respect the character of the historic building as well as the local historic context and complement the streets and blocks containing other historic structures.

Properly executed adaptive use projects should retain the unique and authentic architectural characteristics that are difficult to replicate in new construction. In historic districts, this type of project allows for a building’s continued use and helps to preserve it as a community asset. Re-purposing historic buildings in this manner also helps to upgrade to modern building code standards. Adaptive use can also help preserve historic structures that may have fallen into disrepair and are considered for demolition. Adaptive reuse projects may involve minimal or extensive renovations of both the interior and exterior of a historic structure. Regardless of the extent of renovation, all adaptive use projects involving a historic structure should preserve the original architectural and stylistic integrity of the structure.

Guidelines for Adaptive Use



ACCEPTABLE

- Adaptive use projects that preserve existing historic structures from demolition or when a structure requires extensive restoration following a disaster.
- Adaptive use projects that preserve the original architectural integrity of historic structures.
- Locate adaptive reuse projects in historic districts that include uses other than residential at a corner site, along a busy vehicular thoroughfare, or at the ends of a residential street.
- Signage for adaptive reuse projects that is guided by [Section 4.9 SIGNS of the City's Land Development Code](#).



NOT ACCEPTABLE

- Adaptive reuse projects that detract from the established character of the historic block face.
- Adaptive use projects that alter, cover up, or remove original architectural features on the historic structures.
- Adaptive use projects that incorporate additions with massing proportions that are incompatible with the host structure or adjacent historic structures.



4.9 ACCESSORY STRUCTURES

Accessory buildings are any detached or stand-alone structures on a parcel that are incidental to the principal building. This includes accessory dwelling units (e.g. in-law cottages, granny flats, garage apartments, etc.), out buildings, garages, pool enclosures, sheds and other permanent secondary structures. Accessory structures of all types can be found in different historic districts throughout the City.

Some of these buildings were constructed at the same time as the principal structure on the lot and

share many of the same period-style architectural characteristics. However, other secondary structures have been added over time and may not share any of these distinguishing features. To promote greater compatibility with the principal structure and the larger district, all new secondary structures should be constructed to minimize visual contrast and other adverse conditions. Specific regulations for Accessory structures can be found in [Section 4.3 Accessory Structures](#) of the City's Land Development Code.



4.9.1 ACCESSORY DWELLING UNITS

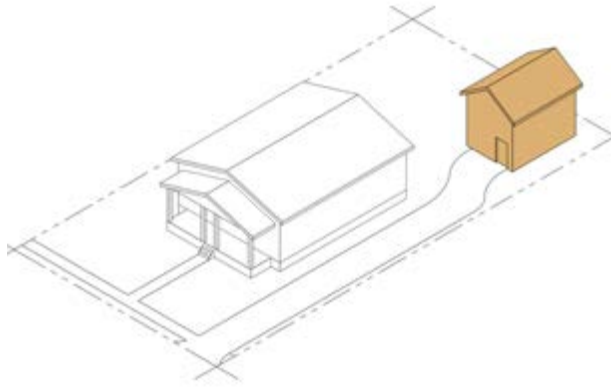

Figure 4.26: *Accessory Dwelling Unit*

While most secondary structures in the City’s historic districts are used primarily for utilitarian purposes, some of these secondary structures are also occupied dwelling units. This type of structure has been around since the initial platting of many of the City’s historic districts and are increasingly being reintroduced in historic residential neighborhoods throughout the country. Accessory dwelling units are often used as a community design strategy to increase the supply of affordable and workforce housing, increase residential density, and to promote demographic diversity. Another benefit of accessory dwelling units is that they can be constructed at any time on existing properties and in conjunction with new single-family infill projects.

In the City of Lakeland, accessory dwelling units are permitted in historic districts and regulated



under [Section 4.3.2 Accessory Dwelling Units](#) of the City’s Land Development Code. This criteria limits the size, height and setbacks of accessory dwellings. Accessory dwelling units can be constructed as stand-alone “cottage” structures or as second-story garage apartments. As secondary structures, these buildings have a small footprint and are typically located at the rear of the primary residence - situated either directly behind it or offset with partial visibility from the street. In several of the City’s historic districts, existing accessory dwelling units incorporate architectural features of the primary residence. New accessory dwelling units introduced in established neighborhoods that acknowledge this precedent condition can blend in with the visual character of the district. When incorporated over garages, accessory dwelling units may have driveway access from a street or from an alley.

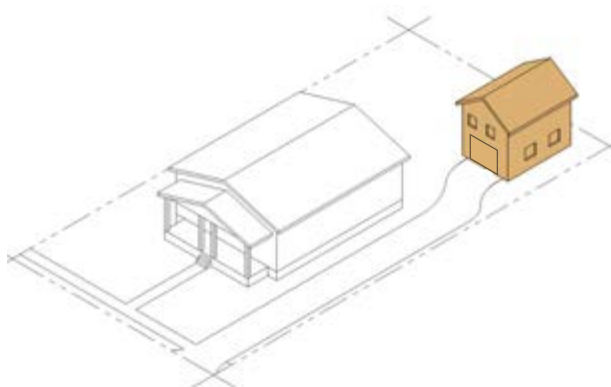

Figure 4.27: *Garage Apartment*



Guidelines for Accessory Dwelling Units



ACCEPTABLE

- Accessory dwelling units that are configured as simple cottages or garage apartments.
- Accessory dwelling units that complement the architectural character of the principal house through the use of similar materials and simplified architectural elements.
- An accessory dwelling unit that is compatible and subordinate in scale and form to the principal house.
- Accessory dwelling units that are compliant with minimum building setbacks to reduce visual impacts from the street and adjacent properties.



NOT ACCEPTABLE

- Standalone accessory dwelling units or garage apartments situated closer than 20 feet from the front house façade.
- Accessory dwelling units that are excessive in scale or compete with the principal structure for visual attention.
- Accessory dwelling units that compromise the privacy of adjacent properties.
- Accessory dwelling units that use materials and/or architectural features not found on or complementary to the principal house.

4.9.2 SECONDARY STRUCTURES

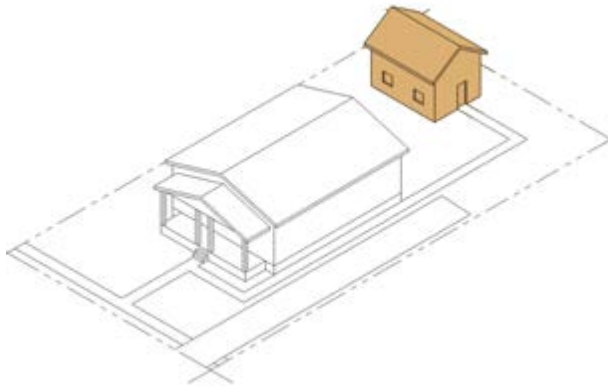

Figure 4.28: *Secondary Structure, Tool Shed or Workshop*

Freestanding secondary structures on residential lots that are used as storage sheds, workshops and for other “lifestyle activity” purposes, are common features in neighborhoods throughout Lakeland. Prior to the introduction of many domestic modern conveniences, a number of routine functions may have been housed in these types of outbuildings, which were modest structures typically located at the rear of the house or towards the rear of the lot. Today, these secondary structures still have a practical or domestic related purpose and are common features in residential areas throughout the city. In

historic districts, secondary structures can be built on site or be pre-assembled units that are installed at the discretion of the property owner. As such, many secondary structures exhibit a generic architectural character that is often visible from the street and from adjacent historic properties. To minimize the potential adverse visual impacts of these structures, they should be screened with landscape vegetation or privacy fencing and adhere to accessory structure setback criteria in the City’s Land Development Code.



Guidelines for Secondary Structures



ACCEPTABLE

- Accessory structures that are placed towards the rear of the property to minimize visibility from the street.
- Landscape screening and/or privacy fencing used in conjunction with storage sheds and other utilitarian outbuildings.
- Pool screen enclosures located directly to the rear of the principal structure and in accordance with the site development criteria indicated in [Section 4.3.3 of the City's Land Development Code](#).
- Secondary structures with gable, slant, shed, or flat roof forms.



NOT ACCEPTABLE

- Detached secondary structures that are located closer than 20 feet from the street-facing façade of the principal house.
- Detached accessory structures that are excessively large and compete with the scale, massing or height of the primary structure.
- Storage sheds that detract from the visual character of the principal structure or adjacent properties.
- Secondary structures with a gambrel or “barn style” roof form.

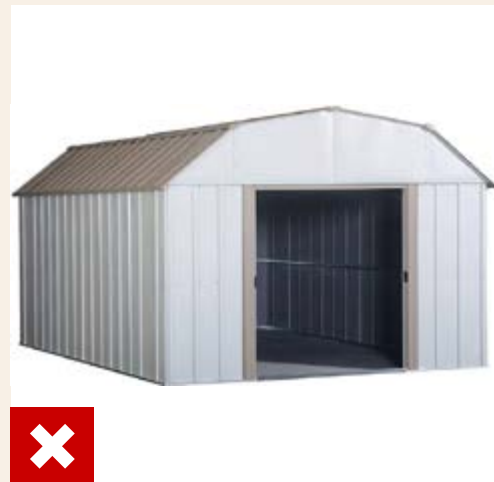

4.10 GARAGES, CARPORTS, AND PORTE COCHERES

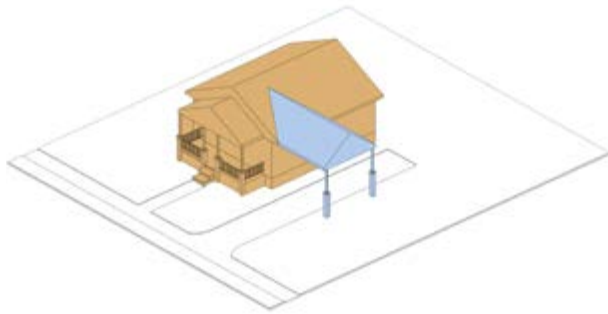
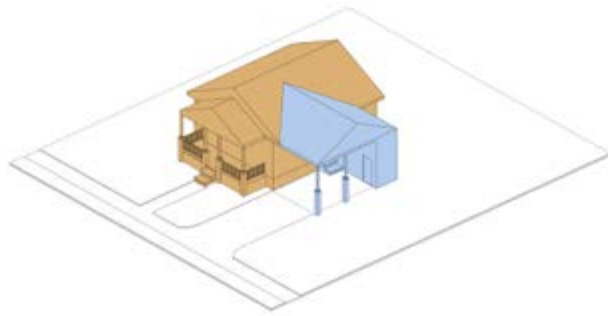
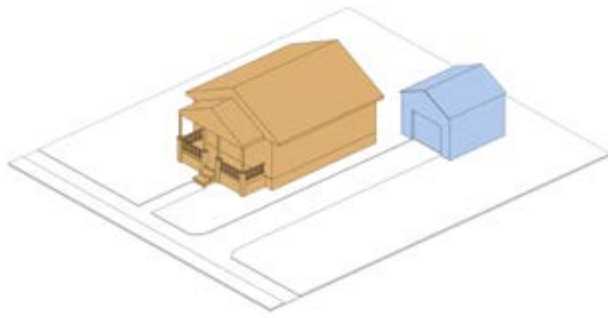

Figure 4.29: *Garages, Carport, and Porte Cochere*

Since the early 20th century, garages have come to reflect the increase in private vehicle ownership and the importance of automobiles in everyday life. Since then, the structures that store or cover automobiles have evolved with the different house styles in Lakeland’s historic districts and are a common

feature found within them. Similar to the carriage houses that preceded them, garages for personal vehicles were initially built as detached, standalone structures at the rear of a residential property. They were accessed from a driveway located at one side of a property extending to the street, or from an alley

running along the back of a property the entire length of a block. By the 1920s, the Bungalow became a predominant house style in Lakeland. Many Bungalows began to incorporate a covered, drive through architectural feature into the massing of the house that came to be known as a porte-cochere. This was a practical feature that offered resident protection from the elements when entering and exiting their vehicles, as well as access to garages at the rear of the property.

During the late 1940s, the porte-cochere evolved into the modern carport. This was a partially enclosed space attached to the primary structure, with a narrow driveway leading from the street to the carport, or if the back of the carport was open, to a detached garage at the rear of the property, similar to the porte cochere. Since the Post-WWII period, house styles have consistently reflected the increasing importance of personal automobile ownership.

Since then, most new residential structures have been designed and constructed with front-loaded garages that are integrated into the overall mass and form of the houses. For infill projects in historic districts, the visual effect of a front-loaded garage on the primary facade of a house detracts from the character of this context. Consistent with other historic properties in the City’s historic districts, it is preferable to construct detached garages that are located at the rear of a property, or for new residential infill, locate an attached garage at the rear of the house. Where lot area or other limitations exist, single-car garages can be integrated into the side of a new infill house, as long as the garage is located at least 20 feet behind the front facade of the house, in order for this structure to blend in with the established automobile storage patterns of historic districts.



Guidelines for Garages, Carports, and Porte Cocheres

ACCEPTABLE

- Preservation of original architectural features and details of historic detached garages and porte cocheres.
- Detached garages and carports placed behind the front elevation of a principal historic structure, except for Ranch style houses, which may have an attached garage.
- Garages and carports accessed from the rear or side alley.
- Columns on porte cocheres matching the design and scale of porch columns on the principal historic structure.
- Garages that are visibly subordinate to the principal historic structure in terms of their massing, form, and height.
- Garages and carports that are related to the period of construction of the principal building on the lot through the use of complementary materials and simplified architectural details.
- Garage doors in proportions and materials similar to those traditionally found in the historic districts.
- Demolition of historic detached garages may be considered for those that are structurally compromised beyond reasonable repair.



NOT ACCEPTABLE

- Front-loaded attached garages, except for Ranch style houses.
- Garages that overwhelm the principal structure on the lot due to their massing, form, or height.
- Replacing two single-car width garage doors with one double-car width garage door.
- Aluminum carports that are visible from the primary street.



4.11 SITE ELEMENTS

Principles for Site Elements

Respect the Historic Context

New site elements should complement, not detract from, historic site elements, the character of the historic structure they serve, and the surrounding district. When considering specific site elements (e.g., streetscape, topography) the surrounding context is important, since the integrity of various elements varies from block-to-block.

Routine Maintenance is Essential for Preservation

With proper maintenance, many historic site elements can last for centuries. Routine maintenance of walls, sidewalks, monuments, landscaping, curbing, and other decorative and functional site elements is essential to prevent deterioration.

Preservation of Features in Place is Preferred Over Replacement

Maintaining and repairing historic site elements is preferred over replacing those elements as to

maintain the character of the public right-of-way and district.

However, if elements are deteriorated beyond repair (more than 50%), in-kind replacement using new components that match the original in form and materials is favored while replacement with comparable substitutes will be considered.

More Flexibility in Treatment and/or Replacement May be Considered in Locations Not Visible from the Public Right-of-Way

Site elements that are not visible from the public right-of-way are less likely to detract from views of the historic structure or the overall character of the district. More flexibility in the treatment and/or replacement of site elements located in rear yards and other areas of the site that are partially or wholly concealed from the public right-of-way may be considered.



Brick Driveway



Ribbon Driveway



Concrete Sidewalk



Brick Sidewalk

The development of Lakeland’s historic neighborhoods included common patterns in features associated with residential yards. While most of the site elements within this sub-section are seen in the front yard, many features, such as mature trees, fences and walls, and driveways, can also be found in side and rear yards.

Front yards are semi-public open spaces between the principal structure and the public right of way;

corner lots have two front yards. In historic districts, front yards play a major role in defining the visual character and appeal of each house style.

Along a block face, front yards typically incorporate a combination of different features that help anchor the house to its lot and the lot to the established neighborhood development patterns, such as landscape features, fences and walls, sidewalks and driveways, and off-street parking.

4.11.1 LANDSCAPE FEATURES

Landscape features play both a functional and aesthetic role on properties of historic houses and infill structures. Whether formal or informal, landscape features have visual influence on the character and appeal of the primary structure. The organization of a property’s ground plane (e.g. grass lawns, xeriscape, etc.), combined with other mature vegetation (e.g. trees, hedges, shrubbery, etc.) connects each house along the street to a cohesive neighborhood framework. In historic districts, vegetation for existing and infill properties should be installed to complement the primary structure, contribute to a sense of permanence and help screen other site features that could diminish the visual character of the principal structure.

Each historic district in Lakeland has properties with mature trees and tree canopies. These trees integral to the historic and natural setting and should be preserved as contextual assets for individual houses, as well as for neighborhood character. For existing houses, as well as future infill projects, mature trees should be maintained and preserved to the greatest extent possible as they contribute to sense of place, aesthetic character of the historic neighborhood, and sustainable conditions. For infill projects that require the removal of mature trees, [Section 4.5.10.1 of the City’s Land Development Code](#) outlines criteria for tree preservation, removal and replacement.



4.11.2 FENCES AND WALLS

Wall and fences are also prominent site elements in many of the City’s historic districts. Most of these features have been added over time and consist of wood, wrought iron or decorative metal, stone or stucco. Walls and fencing should complement the style of the primary residence and should not obscure the facades of historic structures. While they create physical divisions between private property and the public realm, they allow visual access to the principal structure. Where they exist, historic walls and fences that accompany historic houses should be preserved and maintained with the principal structure.

Other than retaining walls 18 inches or shorter, new walls in front yards are discouraged in historic districts. Other features such as hedges and picket fencing are better choices for front yard definition. These features should be limited in height to 48 inches above the ground and should extend from both sides of the house and across the front of the property. Privacy fencing in historic districts should be limited to the

sides of a property, extending from the front facade of a house to the rear property line (must be setback from rear property line by 3 feet if an alley exists).

The type of front yard fencing that best complements historic houses are those that are at least 50% open. This allows for visual access across the front yard and does not detract from the general character of the streetscape. Traditional wooden or wrought iron (or other decorative metal) picket fences are the most compatible with historic houses. All new front yard fencing in the City’s historic districts should be designed, installed and maintained to complement the principal structure.

Low retaining walls at the front of the property are evident in some historic districts as well. Where they exist, they should be preserved if they were built at the same time as the primary structure. These features often use the same materials as those on the house and contribute to the historic character of the property.



4.11.3 THE DESIGN AND PLACEMENT OF FENCES

Fences shall conform to the City's Land Development Code, and be compatible with the architectural and historical elements of the Districts. As a general rule, these elements shall require that fence materials complement the existing building in substance and design, and be reviewed by the Historic Preservation Board's Design Review Committee.

The following guidelines are recommended:

1. Wood fences are compatible with the character of the Districts. Compatible styles include: picket, stockade, board-on-board, horizontal slat, and shadowbox, but other styles may also be considered. Although painting of wooden fences is not required, white is encouraged as the historically preferred color.
2. Vinyl fences are only suitable when not visible from the front or side streets (rear yards only) due to the high gloss which is incompatible with original materials in the district.
3. Composite fence material that replicates the appearance of wood may also be considered.
4. Chain link fences are only suitable when not visible from the front or side streets (rear yards only). Black-coated chain link fences are recommended over galvanized.
5. Ornamental wrought iron or other ornamental metals including aluminum fences with a black or bronze finish, may be permitted.
6. Pre-cast masonry or concrete block walls in most cases would be suitable only if the building is of like material.



The placement of fences must also conform to the City's fence requirements as referenced in Sub-section 4.4 of the LDC:

1. **Front Yards:** The front yard is that area between the front line facade of the main building and the front property line. Covered porches (enclosed or unenclosed) shall be considered as part of the main building. Fences in front yards may be adjacent to or on property lines but shall not exceed four (4) feet in height. A corner lot is considered to have two "front" yards.
2. **Side and Rear Yards:** The side yard is that area between the side facade of the main building and the property line and extending from the front facade of the building to the rear facade of the building. The rear yard is that area extending the full width of the lot and situated between the rear facade of the building and the rear property line. Fences in these areas may be adjacent to or on property lines unless the fence abuts an alley, in which case the fence must be set back a minimum of three (3) feet from the alley's edge. Fences shall not exceed six (6) feet in height, and must conform with the sight visibility triangle requirements of the LDC if located near an intersection between two streets or a street and an alley.



4.11.4 SIDEWALKS AND DRIVEWAYS

The primary purpose of sidewalks and driveways is to connect residents to their houses and the public right of way. They also contribute to the general aesthetic qualities of the streetscape, as well as the larger historic district. These conditions are contingent upon the location, size and materials used for sidewalks and driveway features. Although these features may need to be repaired or replaced over time, inappropriate modifications to original walkways may detract from the character of historic houses.

Sidewalks leading from the front of a house or its porch to the edge of the property are usually straight or curved, but always aligned with its primary entry. To accommodate slight terrain changes from the street to the house, sidewalks may be sloped or include a series of steps. Driveways may be sloped to address these conditions.

The minimum width of a front yard sidewalk averages three to four feet, but may vary depending on individual design and how it meets the front porch or entryway. Historic materials used for sidewalks have included concrete and brick with a generally smooth surface for ease of use and functional utility. Although porous pavers may be used as appropriate replacement materials today, loose aggregate or stone is not an appropriate sidewalk material.

Driveways are typically located on one side of the principal structure and usually no wider than ten feet. They may extend to a carport, porte cochere or garage at the side or rear of the house. Some driveways at historic houses often used a ribbon configuration. This was two linear strips of concrete or brick that related directly to where the wheels of the car touched the ground. Appropriate driveway materials in historic districts include concrete, brick and various types of porous pavers.

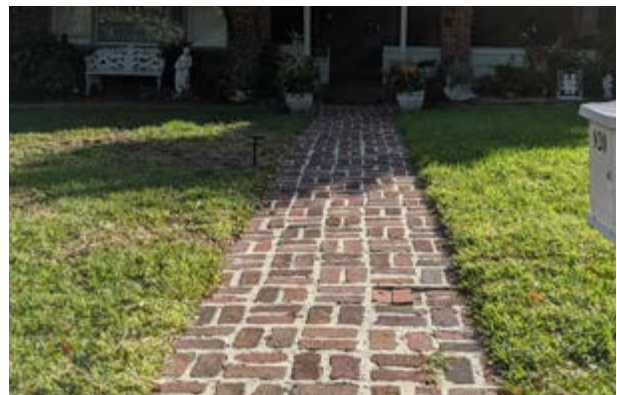
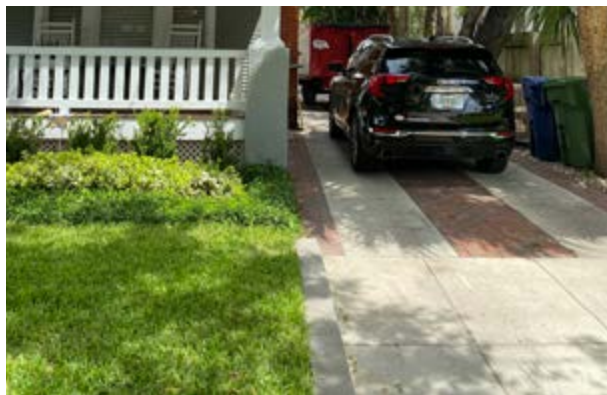

4.11.5 OFF-STREET PARKING

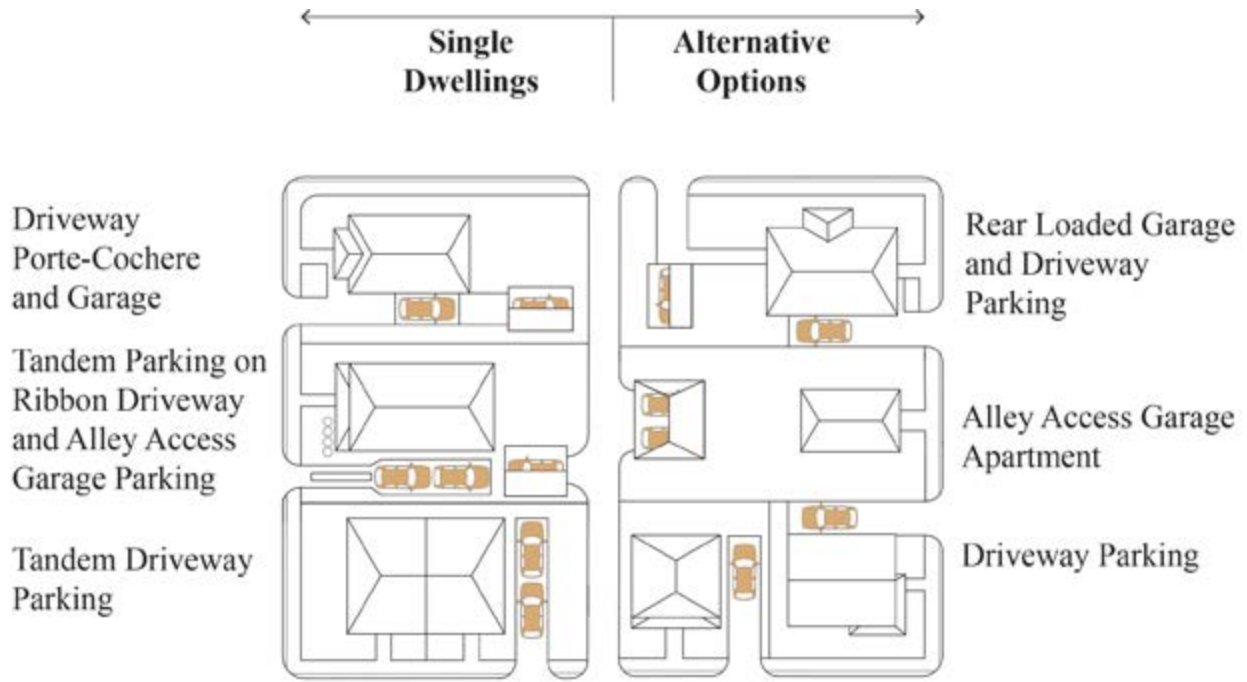

Figure 4.30: Off-Street Parking

The predominant parking pattern within historic districts is the driveway and garage, porte-cochere or carport. Aside from the driveway, all of these are prominent architectural features used to accommodate private vehicles and should be considered in the design of new infill structures.

As increased vehicle ownership in some areas may result in the need for additional on-site parking, broad expanses of front-loaded parking is discouraged. While tandem driveway parking is acceptable for up to two vehicles, additional driveway width for front yard parking on an ongoing basis detracts from the visual character of the house and the district.





ACCEPTABLE

- Site landscape features that are coordinated, installed, and maintained to complement the character of the principal structure.
- Preservation of mature trees on individual lots as natural assets and neighborhood resources.
- Where front yard tree removal is necessary, replacement tree planting should adhere to the standards identified in the City's Land Development Code.
- Retention, repair and maintenance of historic walls and fences.
- Use of compatible design configurations and consistent materials for sidewalk and driveway modifications and replacements.
- Driveways to accommodate tandem parking along the side of the principal structure.
- Fences and walls that harmonize with surrounding structures and streetscape.
- Removal of miscellaneous storage from yard.
- Use of brick for walls and pavements is encouraged.
- Brick, stone or decorative blocks for walkway materials.



NOT ACCEPTABLE

- Removal of healthy, mature front yard trees that contribute to character and setting of individual houses.
- Fencing or walls that exceed 48 inches in height for front yards and 60 inches in height for side and rear yards.
- Driveways that exceed ten feet in width.
- New fences and walls that do not reflect design characteristics similar the original, or those found in the district.
- Cutting down large shade trees; removal of old plants, trees, walkways, or outbuildings before evaluating their importance.
- Neglected and untrimmed lawn areas; keeping stored materials in the yard.
- Alterations to brick streets at curb cuts; changing paving material.
- Destroying relationship of buildings to their environment.
- Leaving trees too close to building which could cause structural deterioration.
- Too many plants and trees cluttering the lawn and obscuring the house.
- Large expanses of asphalt or concrete which increase heat and create an inhospitable atmosphere.
- Semi-circular driveways in all but the Beacon Hill Historic District.

- Retention of plants, trees, fencing, and walkways that reflect the property’s history and development.
- Trees, fencing, and walkways that enhance the character of the historic structure and its setting, rather than hide it.

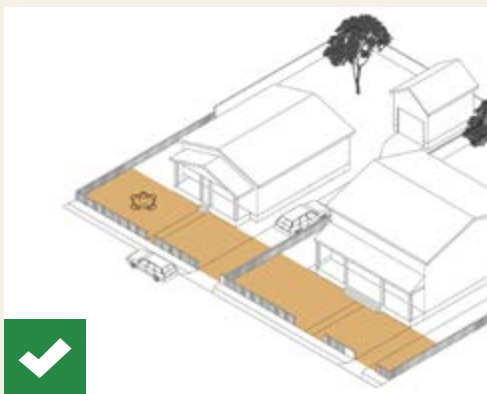
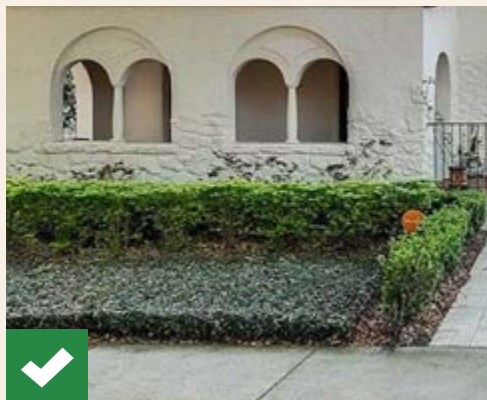

Figure 4.31: Acceptable Front Yard Conditions



Figure 4.32: Not Acceptable Front Yard Conditions



4.12 UNDERSTANDING COMMERCIAL AREA FORM

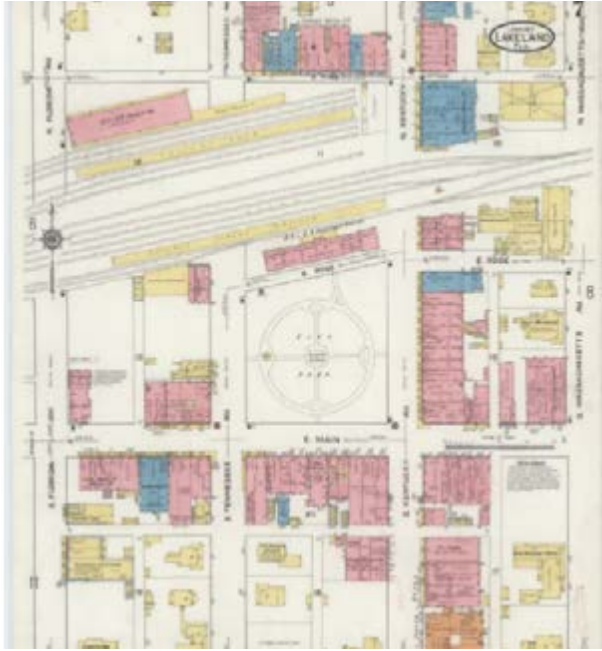

Figure 4.33: Historic Sanborn Map of the Munn Park/
Downtown Historic District.

Source: Library of Congress



Figure 4.34: Street View of Historic Block Face along
N. Kentucky Avenue.

Historic commercial areas in the City of Lakeland are situated in the Munn Park Historic District and along a portion of the South Florida Avenue Community Redevelopment Area (CRA) between the Dixieland and South Lake Morton Historic Districts. Unlike contemporary commercial development patterns with stand-alone structures, these areas are defined by one to three-story rectangular building masses that are contiguous with each other and grouped along a common block face. Understanding the formal conditions exhibited by these historic commercial environments establishes a good foundation for realizing preservation and for identifying best approaches for future infill development and other enhancements.

Commercial district form refers to the aggregate physical conditions and general development patterns of exhibited by buildings in these areas. These Guidelines for commercial areas have been

developed to ensure they retain their historic formal properties, their visual character and their historical commercial arrangement and building form. Similar to historic residential areas, buildings in these two historic commercial areas are irreplaceable assets and should be preserved as part of the City's cultural landscape. These areas also represent a physical record of how commercial activity in the early twentieth century helped shape the early economy of the City.

Historic commercial areas are often subject to redevelopment pressures and building renovations that could result in incompatible conditions or structures that are altered beyond contributing status. These Guidelines are not intended to hamper development or renovation opportunities, but provide property owners, developers, architects and others with information needed to undertake these activities in a manner that is sensitive to the local historic contexts.

4.12.1 COMMERCIAL BLOCK ORGANIZATION



Figure 4.35: *Typical Commercial Block Face*

Several historic commercial buildings in the Munn Park Historic District and a portion of the South Florida Avenue commercial corridor in Dixieland exhibit several unique two and three-dimensional formal design characteristics. Spatial development patterns in these areas reflect a “zero-lot line” building placement on individual parcels along the block face.

The footprints of individual historic commercial buildings in these areas cover most their respective parcels, often with a small open area at the rear for

building servicing and secondary access. This development pattern of commercial structures built “shoulder-to-shoulder” is similar to other small-town historic main streets built throughout the country prior to and just after the turn of the 20th century. The spatial development pattern created by these structures reflects the early development of the City’s concentrated commercial areas. Organized in this manner, these structures were developed to relate to both pedestrians along the sidewalk and vehicles along the street.



Figure 4.36: *Typical Historic Commercial Block Organization*

The second most prominent formal characteristic of the City’s historic commercial “storefront” buildings, is their three-dimensional form or shape. These structures are typically configured as simple one to three story rectangular box masses with



Figure 4.37: *Historic Commercial Block Face*

varying frontage widths and lot depths. While individual massing configurations vary between these structures, their rectangular geometry gives them a modular distinction relative to their integration in the overall block face.

4.12.2 HISTORIC COMMERCIAL BUILDING CLASSIFICATION

Historic commercial buildings are usually classified based on their height, architectural definition and orientation along the street. One-part commercial blocks are one-story structures that are part of a larger block face ensemble or a free-standing structure. The facades of structures may have a single storefront or be divided into multiple storefronts along the sidewalk. Two-part commercial blocks are historic buildings with ground floor retail storefronts and one or more upper stories. This commercial

building type is most often associated with historic “main street” conditions and represents the City’s first multi-use structures. The business block is a type of historic structure that was built at the end of a row of commercial storefronts or at the end of the block. This building type was usually a bank, theater, department store or public building; its location and larger size often serves as a visual anchor or landmark in a historic commercial area.



Figure 4.38: Two-Part Commercial Block



Figure 4.39: Business Block Historic Landmark

Another prominent formal characteristic of historic commercial structures is their facade orientation and architectural definition. Some of these structures are oriented in horizontal manner – often occupying a wider lot along the block face. This results in façade massing proportions that are usually twice as wide

as the height of the structure. Other buildings are oriented in a more vertical manner with narrower massing proportions. These structures usually occupy a narrow lot and have multiple floors stacked above a storefront ground floor.



4.12.3 HISTORIC COMMERCIAL BUILDING FACADES AND ARCHITECTURAL STYLE

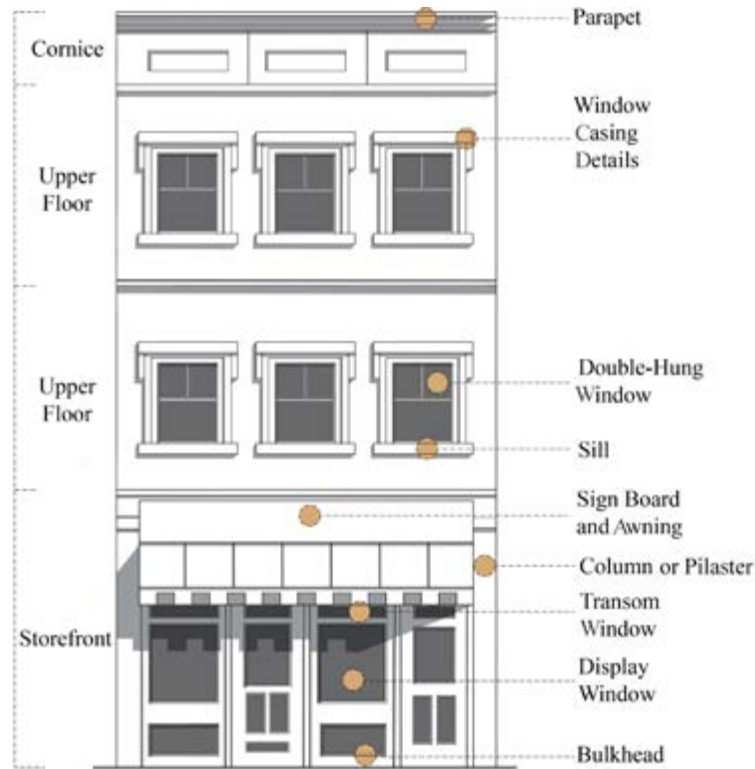

Figure 4.40: Typical Historic Commercial Façade Features

The facades of most historic commercial buildings in the Munn Park Historic district and along South Florida Avenue incorporate a range of architectural details and other features that define their stylistic identity. Commercial architectural style refers to how façade features, such as cornice details, brickwork patterns, window features, and ground-floor storefronts, are arranged to give the building its primary visual character. Architectural styles for historic buildings in Lakeland represent an eclectic mix of popular styles in use during the early part of the twentieth century. These buildings were often influenced by many of the prevailing architectural styles in use during this period, including Romanesque, Colonial Revival, Mediterranean Revival and Neo-Classical. Most historic commercial buildings in Lakeland can be classified as “Vernacular Commercial” – an eclectic style that does not relate directly to a popular or recognized architectural style. Vernacular commercial buildings tend to have more simplified architectural features and details.

This simple visual expression gives these structures a unique identity while contributing to the cohesiveness character of the block face.

Commercial Building Type vs. Style

Building type and style are often used interchangeably to describe historic commercial structures. However, these terms refer to different formal aspects of these structures. Type refers to the basic geometric mass and its floor plan arrangement.

Style refers to a structure’s architectural character and the way certain features, details and ornamentation are combined to define its visual appearance. Style is typically associated with popular design approaches that were in widespread use during a certain timeframe.

Another prominent formal characteristic of historic commercial structures is their facade orientation and architectural definition. Some of these structures are oriented in horizontal manner – often occupying a wider lot along the block face. This results in facade massing proportions that are usually twice as wide

as the height of the structure. Other buildings are oriented in a more vertical manner with narrower massing proportions. These structures usually occupy a narrow lot and have multiple floors stacked above a storefront ground floor.



Figure 4.41: Commercial Façade Horizontal and Vertical Orientation



Figure 4.42: Commercial Façade Fenestration Patterns



Source: Historic Lakeland, Inc.



Source: Historic Lakeland, Inc.

With all buildings situated at the front property line, the commercial block face exhibits a discernible “street wall” condition. This streetwall creates an implied frame for the edge of the street or an adjacent open space. In the Munn Park Historic District, these are some of its more perceptible formal

characteristics. The streetwall creates unique and enduring urban design conditions that are inherent to the area’s historic identity. They should be protected as part of the primary contextual framework for this area and serve as precedent conditions for future infill development.

4.12.4 NEW CONSTRUCTION AND INFILL DEVELOPMENT

New construction, or infill development is a normal activity in the evolution of historic commercial districts. Over time, these activities may have major implications on the preservation of individual buildings as well as the integrity of the district itself. New construction in these areas should both complement or enhance existing structures and blend in with the immediate context. Infill development generally refers to construction activity on a current vacant lot. It can also occur on property where a structure has been demolished or lost to some other event, or as a replacement structure for one that has been relocated. Infill development should always be sensitive to the established conditions and development patterns that exist on adjacent parcels. Building scale, setbacks, orientation, entries and façade character are primary considerations to ensure infill buildings are well integrated into a historic context.

The purpose of these Guidelines is to protect the integrity of the City’s historic commercial areas by

promoting infill development that achieves a good urban design fit. These guidelines are not intended to mandate architectural styles, require certain architectural features, nor limit creativity. They are however intended to promote infill design that enhances and strengthens the local historic commercial contexts.

Infill development in commercial areas should be well-suited to historic contexts and should incorporate construction methods that relate to the current time period. While existing historic structures can serve as inspiration for new infill development, these Guidelines do not require a direct replication of existing historic buildings. Doing so creates a false sense of historicism and may in fact detract from the authentic character that already exists. However, with the construction of buildings over three stories in height, historic buildings over three stories in height should be referenced in designing new, taller structures.



Figure 4.43: *Commercial Infill Conditions*

Historic commercial buildings in the Munn Park Historic District and a portion of the South Florida Avenue commercial corridor are grouped together along the block face to create a unique set of physical conditions. As some of the City’s earliest commercial structures, these buildings reflect a contiguous “street wall” along the block face. Over time, the consistency of this development pattern may change due to a structure being demolished or lost to some

other event. The loss of a structure along the block face creates a type of visual “missing tooth” condition. This vacant parcel presents an opportunity for a small-scale commercial or multi-use development that would fill in an otherwise prominent void along the block face. Commercial infill on historic blocks should re-establish the consistency of the street wall and reflect compatible scale, proportions, and massing with adjacent structures.

Relative to infill commercial development along a historic block face, or modifications to existing historic commercial buildings, these Guidelines are primarily concerned with maintaining compatible conditions with adjacent commercial facades. All new infill development along historic block faces should also adhere to the zero front setback or zero lot line

development pattern precedent that characterizes these areas. This “build-to” property line condition maintains a direct relationship between ground floor building uses, storefront windows and the adjacent sidewalk. These formal properties also contribute to the contiguous “streetwall” conditions that define the City’s historic commercial block faces.

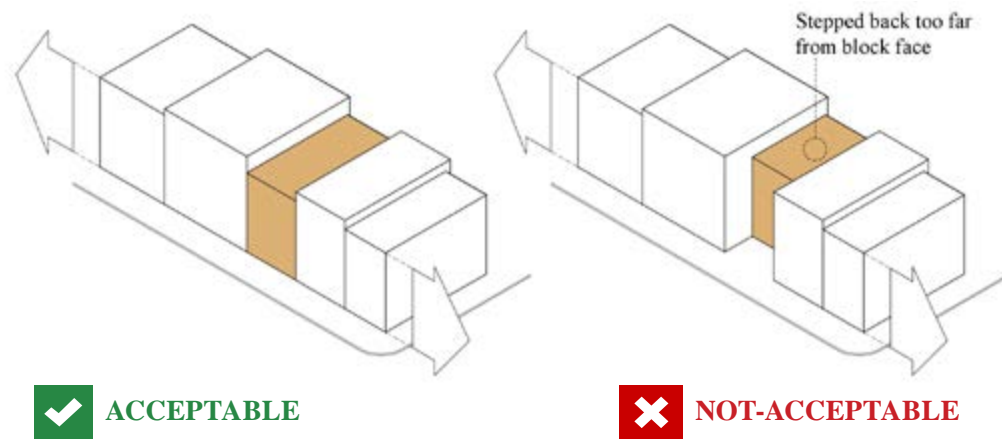

Figure 4.44: Acceptable and Not Acceptable Setbacks for Commercial Infill

New commercial multi-use infill buildings along a historic block face, or existing historic structures undergoing renovation should reinforce and support the established development patterns, building massing conditions, the unique identity of the building façade and the relationship between the building and the public sidewalk.

Unless located on a corner parcel, these structures typically have one primary street-facing façade. With limited commercial presence, the visual and

architectural expression of these buildings is concentrated here. As such, they are typically layered distinctive design features from the ground floor storefront, up to the cornice at the top. These include ornamental brick patterns, prominent window details and surrounds and decorative cornice details. Historic commercial structures that undergo renovations should preserve these façade conditions as integral features, while new commercial infill should recognize them as design points of reference.

4.12.5 PRESERVING HISTORIC COMMERCIAL FACADES

One of the most distinctive characteristics of these historic commercial buildings is the architectural composition of their facades. The facades of these structures can have a one or multi-story horizontal orientation or a vertical, multi-story massing orientation. Although each building facade is different, they are composed of both similar and unique architectural features such as a ground-floor storefront with large display windows, one or more entry doors directly adjacent to the sidewalk, overhead awnings, distinctive brick details, ornamental window surrounds on the upper floors and a decorative cornice at the top. These Guidelines are intended to assist property owners in preserving, restoring and rehabilitating these structures and their unique

façade conditions. Given their role in the evolution of the City, these structures should be preserved cultural assets that reflect the historic identity of the downtown commercial area.

The design, form and materials of commercial buildings are significant components of their individual historic character and the visual integrity of the block face. The main character-defining features of their facades convey the developmental history of the City's first commercial district. Retention and maintenance of these features are strongly encouraged as essential processes to ensure their ongoing preservation and that of the district.

4.12.6 CORNICES

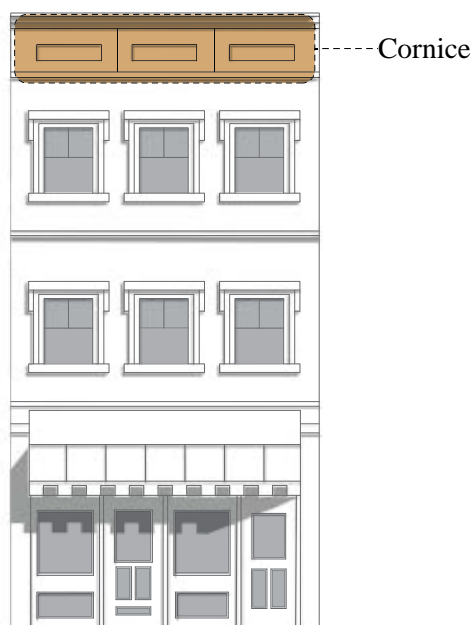

Figure 4.45: *Historic Commercial Building Cornice Details*

Cornices are horizontal architectural features that extend across the top of individual buildings. Cornices often create a vertical extension to the roof behind and are often referred to a roof parapet. From the front, cornices are typically comprised of bands of architectural details that terminate the building's



overall height in a visually expressive manner. These features include the cornice band at the very top, the frieze band and the architrave. Depending on the building's design, cornices use one or more different materials including brick, concrete block, wood and occasionally stone or terra cotta.

Guidelines for Commercial Cornices



ACCEPTABLE

- Retention and maintenance of all original cornice details and materials.
- Repair, rather than replace deteriorated cornice features.
- Where necessary, replace cornice features with “in-kind”, similar historic materials, or compatible substitutes.



NOT ACCEPTABLE

- Removal of an entire cornice feature when only a portion is deteriorated.
- Significant alterations of cornice features to “modernize” a building’s façade.



4.12.7 WALL ARTICULATION

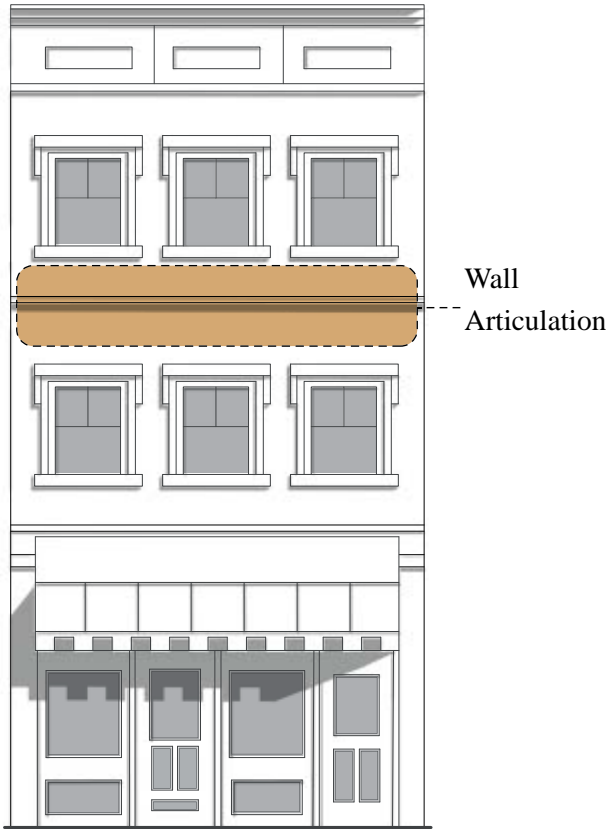

Figure 4.46: *Historic Commercial Building Wall Articulation*

Historic commercial buildings often have one major façade that may appear as a flat wall plane. However, closer examination often indicates a wall plane with a combination of subtle, yet visible articulations. These include changing brick patterns with

indentations and corbelling, and other architectural features such as pilasters, brackets and arches. Many of these features appear above the ground floor, but they are all integral components of a historic commercial building’s architectural expression.

Guidelines for Wall Articulation



ACCEPTABLE

- Retention and maintenance of all original wall articulations, details and materials.
- Repointing brick details.
- Replacement of brick details with similar or compatible materials.



NOT ACCEPTABLE

- Removal or covering up original wall details or materials to “modernize” a building’s façade.

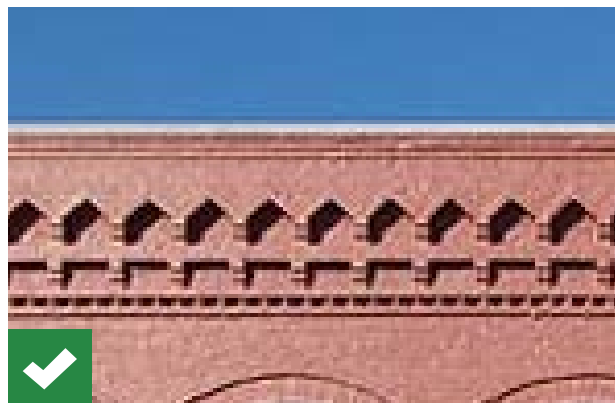

4.12.8 WINDOWS AND DETAILS

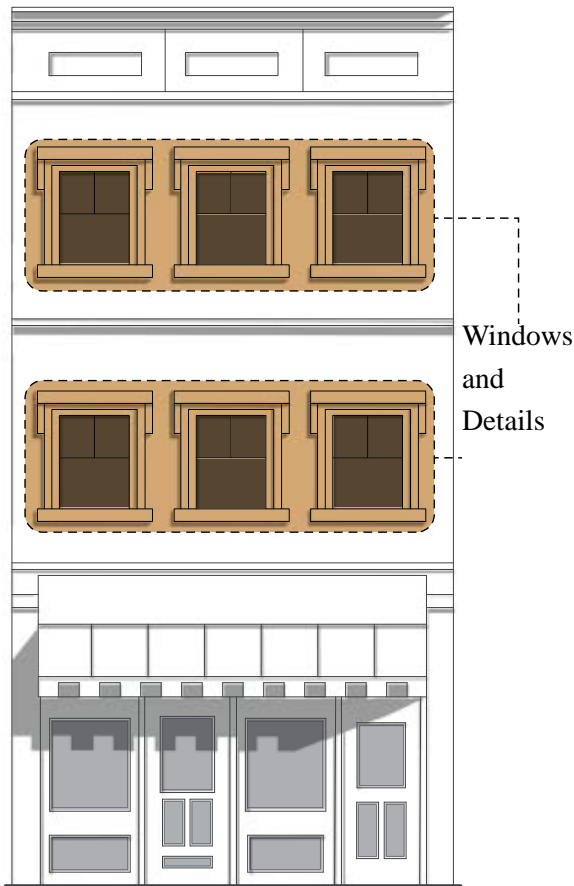

Figure 4.47: Historic Commercial Building Windows and Details

Windows on the upper floors of historic commercial buildings are configured in different ways. Commercial structures built prior to the 1930s typically had vertically-oriented wooden, “punched” windows, or window groupings. These windows often had window detail surrounds or decorative features above, on the sides and below the window opening. These details essentially celebrate individual windows as prominent features of the building’s façade and help to visually anchor windows into the larger wall plane.



Historic commercial buildings constructed between the 1930s and the start of WWII often incorporated larger metal frame windows that were more horizontal in orientation. Commercial buildings with these window patterns and less ornate wall planes began to incorporate more contemporary preferences and signaled a departure from revivalist design.

4.12.9 WINDOW FILM POLICY

The Historic Preservation Board established a window film policy on June 17, 2010 for commercial structures located within any historic district as well as the Lakeland Downtown Development Authority area and the Dixieland CRA. This criterion was developed after consultation with the State Historic Preservation Office architect, the Secretary of Interior’s Standards, the Munn Park Design Guidelines for Non-contributing Buildings, and the Dixieland Commercial Corridor Design Guidelines.

The use of reflective glass and reflective film is prohibited. Glass shall be transparent without color except for stained or art glass provided that is in character with the style of the building. Glass block is not considered transparent and is not permitted when visible from the public right-of-way.



Window Film Properties

First floor street level windows are considered pedestrian scale and must meet the following or equivalent specifications:

Visible light transmittance	67%
Total solar transmittance	50%
Total solar reflectance	11%
Total solar absorbance	39%
Visible light reflectance – interior	11%
Visible light reflectance – exterior	11%
Winter U-value	1.06
UV rejected	99%
Glare reduction	24%
Shading coefficient	0.66
IR rejection	77%
Total solar energy rejected	43%

Second floor windows and above must meet the following or equivalent specifications:

Visible light transmittance	38%
Total solar transmittance	39%
Total solar reflectance	16%
Total solar absorbance	45%
Visible light reflectance – interior	11%
Visible light reflectance – exterior	14%
Winter U-value	1.08
UV rejected	99%
Glare reduction	57%
Shading coefficient	0.46
IR rejection	85%
Total solar energy rejected	60%

Figure 4.48: Window Film Properties

Guidelines for Windows and Details



ACCEPTABLE

- Retention and maintenance of all original windows and window details.
- Repair, rather than replace original wooden windows and details that are not deteriorated.
- Replacement of deteriorated windows and details with similar materials.



NOT ACCEPTABLE

- Covering up, altering or removal of original windows and details that are not deteriorated.
- Introduction of dissimilar windows and details that create contrasting conditions.

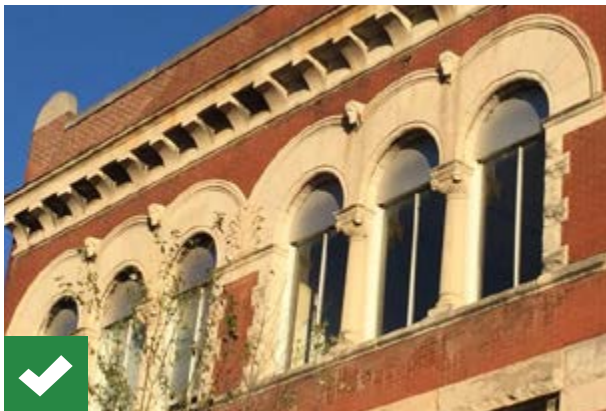

4.12.10 SIGNAGE AND AWNINGS

Principles for Signage

Respect the Historic Context

New signs should complement, rather than compete with, the character of a historic building and the surrounding district. Not all allowed signage types are appropriate to individual historic districts or landmarks. Therefore, careful consideration should be given to historic context, building forms, and site layout when selecting, designing, and reviewing new signage. New signs should be pedestrian-oriented and appropriately designed in terms of size, placement, and materials. The covering or obscuring of the character-defining features of a building will be avoided.

Encourage a Visually Interesting Streetscape Free of Clutter

Signs can create a visually pleasing streetscape as well as improve pedestrian and traffic safety;

however, they can also be distracting if not designed properly. Consider the overall number, type, size, and design of signs used on individual buildings and along the streetscape to ensure new signs respect the historic surroundings and do not result in visual clutter.

Reinforce the Pedestrian-Oriented Nature of Commercial Uses

Signage was most prevalent historically in areas and on buildings that were used for commercial purposes; however, as Lakeland's historic districts evolve over time, the adaptive use of individual structures may result in the introduction of signage in more areas and on more building types. Regardless of the location or building type, signage should be designed and scaled with pedestrians in mind.



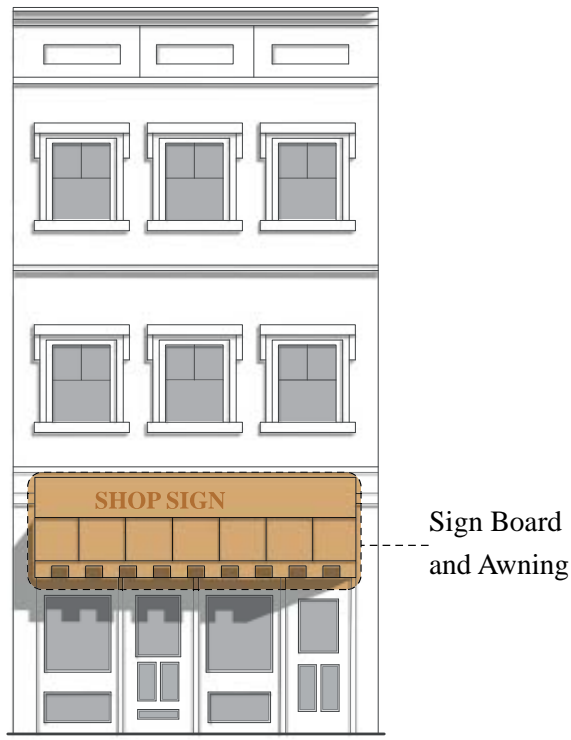

Figure 4.49: *Historic Commercial Building Signage and Awnings*



Signage is an important component of historic building facades. Signs can be placed in a number of different locations and can vary in size. Some signs are integrated into the wall plane, while others are applied or installed. When these structures were initially built, signs were one of the primary features for gaining public recognition of your business and location. Signs are the most flexible and versatile features of historic commercial facades and are regulated by [Section 4.9 of the City’s Land Development Code](#).

Awnings and canopies extend over ground-floor shop windows were common façade features on historic commercial buildings. Projecting from the building face and over the sidewalk, these features provided shade for potential patrons and storefront windows. These features play an important role in how the general public interacts with these structures and should be preserved as unique architectural features that lend character to the entire commercial block face.

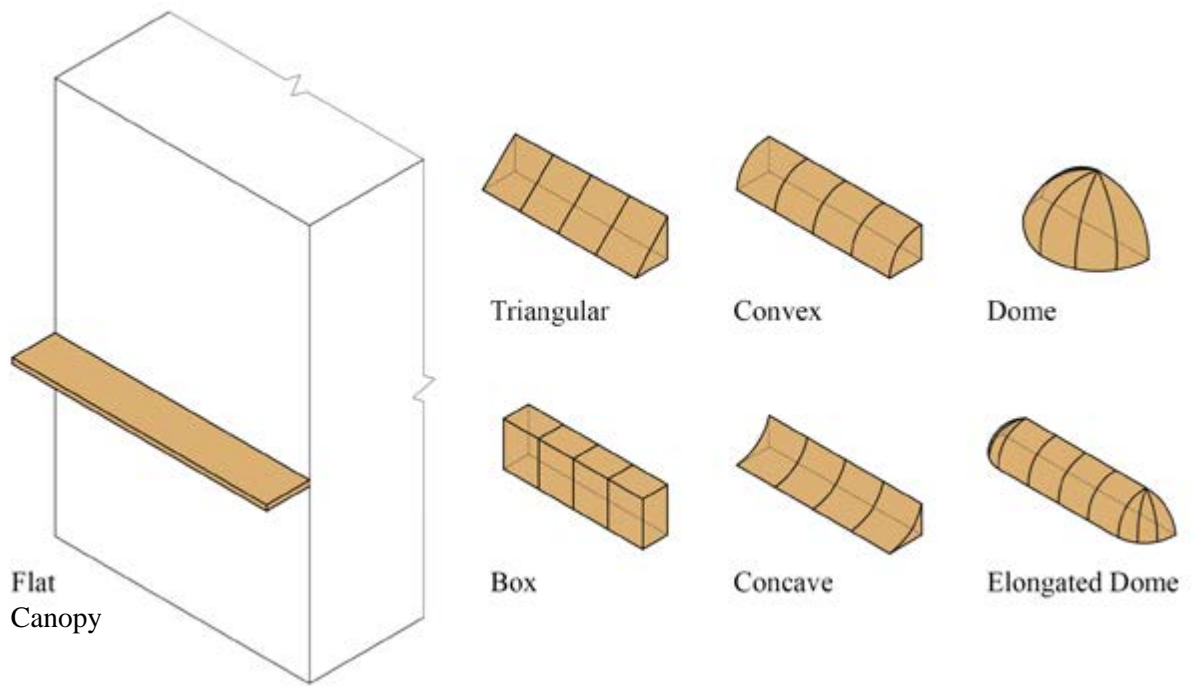

Figure 4.50: Types of Awnings



Guidelines for Signage and Awnings



ACCEPTABLE

- Retention and maintenance of original signage and awnings.
- Replace original signage, awnings and canopies that are deteriorated with similar features that are compatible with the host structure.



NOT ACCEPTABLE

- Signage, awnings and canopies that create contrasting conditions or incompatible with the requirements in the Land Development Code.



4.12.11 STOREFRONTS

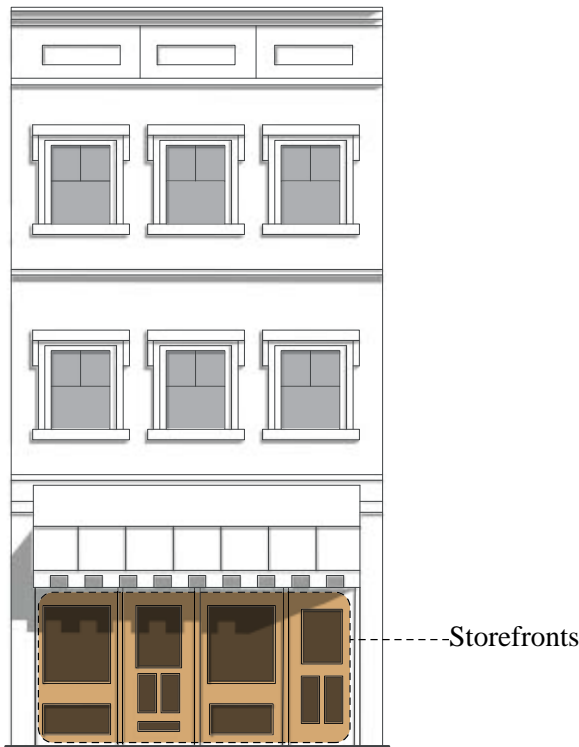

Figure 4.50: Historic Commercial Building Storefronts

Storefronts or shop windows are some of the most important character-defining features of historic commercial buildings. Storefronts are large glazed areas on the ground floor of these buildings and were intended to provide visual and physical access to potential patrons. Storefronts are comprised of various architectural features, such as bulkheads (solid panels at the base of the display window), recessed entrances, and transom windows above the display window.

Although they are an integral architectural component of these buildings, storefronts are also a façade feature that is likely to be altered over time. As property owners seek to enhance their business



entrances, appeal to potential patrons, introduce other ground-floor uses, or for other reasons, storefronts in these buildings have demonstrated a type of flexibility in accommodating changes in building usage and ownership.

In other parts of the country, some adaptive reuse trends for historic commercial structures reflect alternative strategies for storefronts. In many situations, building owners are attempting to expand their presence along the public sidewalk adjacent to historic storefronts. This trend often results in the relocation of storefront windows to create an outdoor patio space at the entrance. While the Downtown area has a few examples of this practice,

it can have a detrimental effect on the historic character of the host structure and the district. This practice often results in the removal of the original storefront windows and the addition of a new window wall ten or more feet behind.

renovation projects that include this condition must coordinate it with other components of the façade to ensure the historic integrity of the structure is not compromised.

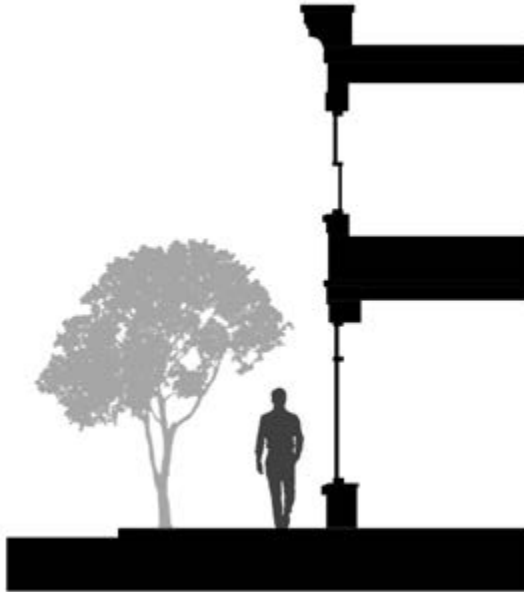

Figure 4.52: Original Storefront Location

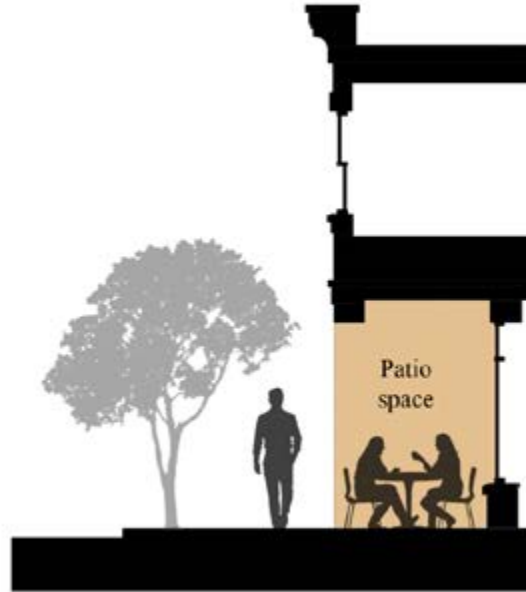

Figure 4.53: Relocated Storefront



Guidelines for Storefronts



ACCEPTABLE

- Storefronts that retain their original configurations, glazed areas and architectural character.
- Preserve and repair storefronts in a manner that is compatible with the historic character of the structure itself.
- Design strategies for storefronts that extend the useful life of the structure or brings it up to current day building codes and standards.
- Use of replacement storefront materials that are comparable to original materials in size, color, shape and texture.



NOT ACCEPTABLE

- Original storefronts that are destroyed, covered up or modified beyond recognition.
- Significant storefront alterations that detract from the character of the host structure.
- Removal of an entire storefront when only a portion is deteriorated.



5



HOUSE STYLES



5.1 HOUSE STYLES IN LAKELAND’S HISTORIC DISTRICTS

The City of Lakeland has a broad range of single-family residential structures that reflect different popular architectural styles used from the late 19th century until the mid-20th century. Often referred to as “period styles,” these houses reflect the prevailing stylistic preferences and available materials used during a certain time period. These house styles represent the first eighty or more years of community development in Lakeland from its founding in 1885 to the period just after World War II. Initially, house styles in the city evolved from basic wood frame “folk” structures built by some of the City’s earliest settlers to the higher architectural styles that were erected by prosperous local residents, as well as newcomers. As the city became more affluent, and the railroad brought visitors to the area, several

more sophisticated architectural styles were imported from other places to Lakeland. Many of these styles, such as the Bungalow and the Mediterranean Revival/Spanish Colonial became more prevalent during the Florida Land Boom era and incorporated familiar regional and national trends in residential design. While many of the house styles were often influenced by others, most were the result of architects and builders interpreting classical design trends, local environmental conditions, modern lifestyle adaptations and economic circumstances. Today, hundreds of historic houses of varying architectural styles define the visual character of the City’s residential historic districts. They create a visual brand for each district and give each a unique identity and sense of place.



HISTORIC HOUSE STYLES TIMELINE

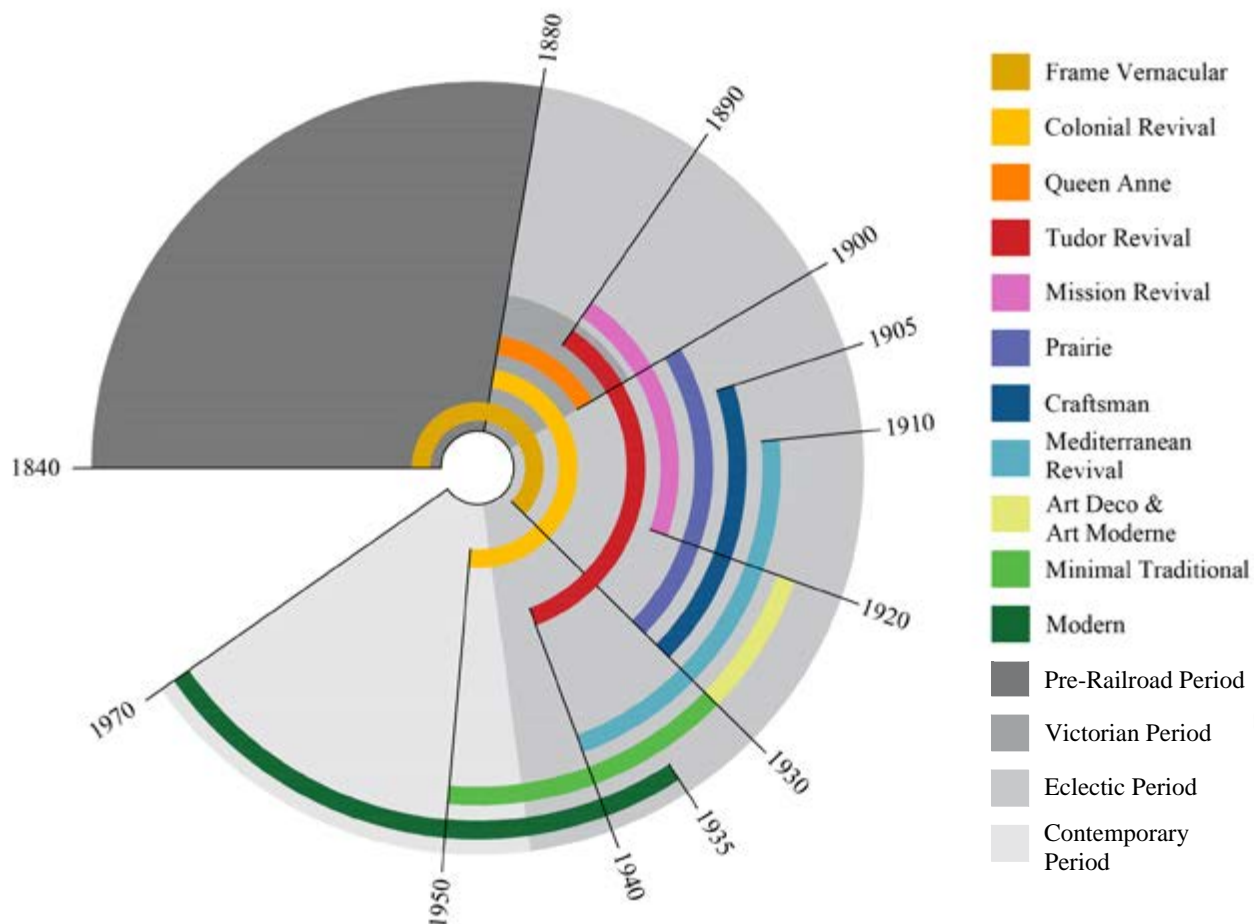

Figure 5.1: Historic House Styles Timeline





Source: City of St. Petersburg “Design Guidelines for Historic Properties”.

This section of the Design Guidelines was created to assist property owners properly identify their house styles, understand many of the style defining features and serve as a point of reference for future infill development in the City’s historic districts. Understanding the stylistic features and other significant architectural characteristics of the different historic houses in the City’s historic districts is critical in preserving their integrity when making repairs, modifications and additions.

There are over a dozen house styles in Lakeland that are considered historic today. These include house styles used from 1870, when the City was founded, up to 1945 which coincides with the end of World

War II and the start of a new era in residential design in much of the United States. These houses represent an eclectic mix of vernacular styles that evolved from traditional building methods used during the City’s pioneering days, residential styles popular with local builders, and more sophisticated “imported” styles introduced to Lakeland by new residents. Several of these styles coincided with the first twenty-five years of growth during the twentieth century. This period is often referred to as the Florida Land Boom era – a short period of enormous growth and residential speculation that touched every existing community and fostered new communities throughout the State.

HOUSE STYLES MATRIX

 <p><i>Frame Vernacular</i></p>	<ul style="list-style-type: none"> • Rectangular or L-shaped one and two-story mass • Simple gable roof • Full-width porch • Exposed rafter tails • Wood siding
 <p><i>Bungalow</i></p>	<ul style="list-style-type: none"> • Rectangular mass with broad façade conditions • Gable or hip roof variations • Wide roof eaves and overhangs • Accentuated porch and features • Exposed rafter tails • Divided upper window sashes
 <p><i>Mediterranean Revival</i></p>	<ul style="list-style-type: none"> • Rectangular or square mass • Flat roof • Decorative parapet features • Stucco wall finishes • Barrel tile wall overhangs
 <p><i>Colonial Revival</i></p>	<ul style="list-style-type: none"> • Rectangular mass • Cross gable roof • Symmetrical façade composition • Multiple street-facing windows with shutters • Ornamental entrance features • Wood siding or brick wall material



Queen Anne

- Two story asymmetrical mass
- Multiple roof profiles
- Contrasting tower or vertical massing feature
- Broad, wrap-around porch with decorative “gingerbread” features



Four Square

- Two-story rectangular or square mass
- Hip roof
- Symmetrical façade arrangement
- Full-width front porch
- Wide eaves and overhangs



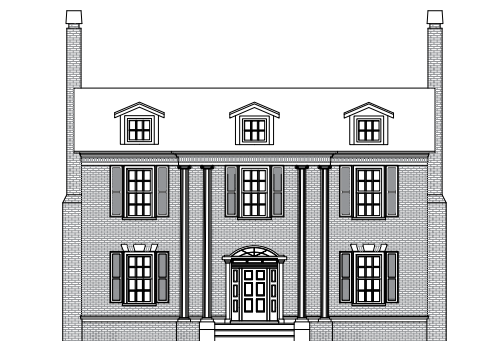

Greek Revival

- Two-story rectangular mass oriented parallel with the street
- Cross gable main roof
- Full-height entry portico with slender columns and gable roof
- Symmetrical façade composition
- Decorative entry door surround



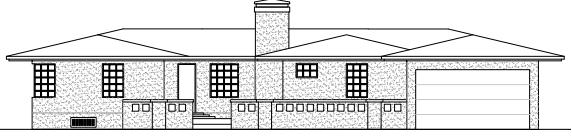

Neo-Classical

- Two-story rectangular mass oriented parallel with the street
- Full height entry portico with slender columns and flat roof
- Cross gable roof
- Symmetrical façade composition
- Three street-facing roof dormers

 <p><i>Modern</i></p>	<ul style="list-style-type: none"> • One-story horizontal mass oriented parallel with the street • Low-pitched, simple gable or hip roof • Off-center front entrance • Asymmetrical façade composition • Attached garage as part of main structure
 <p><i>Tudor</i></p>	<ul style="list-style-type: none"> • Rectangular, square or L-shaped mass • Steeply-pitched cross gable roof • Prominent front-facing gable • Grouped, tall narrow windows with multi-plane glazing

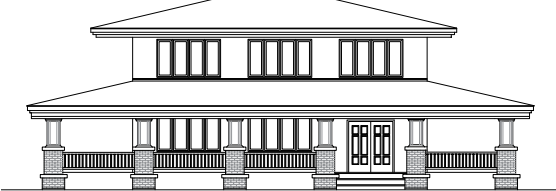
Other Unique Variations

 <p><i>Prairie</i></p>	<ul style="list-style-type: none"> • Two-story mass • Low pitched hip roof with deep overhangs • Full front porch with large columns and support piers • Symmetrical façade composition • Façade details emphasizing horizontal profile
 <p><i>Dutch Colonial</i></p>	<ul style="list-style-type: none"> • Gambrel or side gable roof • Large second floor dormers • Multi-paned, double-hung windows • Covered porch or entryway • Ornate front door with sidelights and overhead fan light

5.2 FRAME VERNACULAR



Figure 5.2: Facade Conditions from Frame Vernacular House Styles

Frame Vernacular architecture is not defined by a formal architectural style, rather refers to a regional or “folk” architectural style. These houses were built with local materials and local labor, without formal plans, and for the most were economically priced at the time of construction. A Frame Vernacular home will typically have a rectangular or L-shaped plan to maximize cross-ventilation and will be supported by spaced masonry piers (usually brick) to further aid in natural ventilation and protect the structure from high waters. The Framed Vernacular is fronted with a simple entrance or end porch and is typically not built with railings. The columns, built out of wood, are evenly spaced

across the façade and are narrow with few details. Similarly, the window and front door are built out of wood with simple ornamental woodwork. The windows are evenly spaced across the façade and are generally 2- or 4-pane double-hung sash windows. The exterior walls are most commonly horizontal drop siding and weatherboard. Lastly, depending on when the home was built, the roof can either have a steep pitch with wood shingles (earlier periods) or a lowered roof pitch roof with metal shingles/sheets (later period homes). The roof is supported by unornamented rafters that extend beyond the face of the wall.





Figure 5.3: Frame Vernacular Facade Features



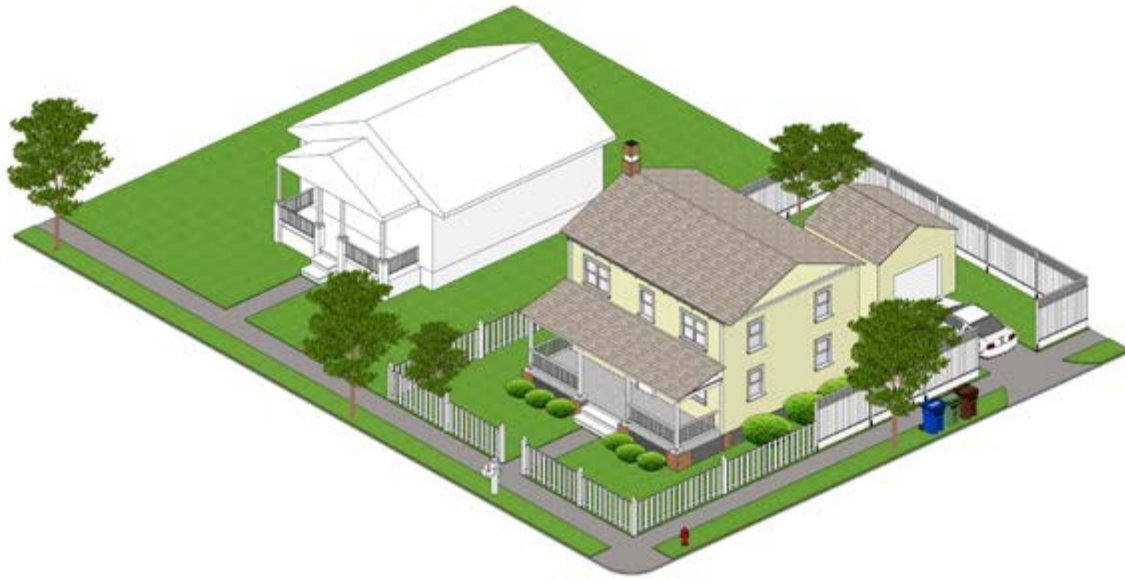

Figure 5.4: Frame Vernacular House and Neighborhood Context

The Frame Vernacular house style was one of the first residential styles to emerge in the City of Lakeland’s formative years. In several historic districts, this informal house style predates most of the other “period-styles” that emerged just prior to

and after the turn of the 20th century. These modest house styles reflect the longevity of their respective neighborhoods and reinforce many of the community design principles still in use today.



5.3 BUNGALOW/CRAFTSMAN



Figure 5.5: Facade Conditions from Bungalow / Craftsman House Styles

The Bungalow, or Craftsman, style was the most common housing form in the United States in the early 20th Century. It was economical to build; as affordable housing, it became widely used in the early development of suburban residential areas across the country. The Bungalow is known for its height, one or one-and-a-half stories that was nestled into the earth. The plan of the house is typically rectangular, and like the Framed Vernacular, is supported by spaced masonry piers (usually brick) to aid in natural ventilation and protect the structure from high waters. Fronting the Bungalow is a wide and spacious porch that sometimes wraps around the side, serving as an outdoor living room. Its front porch encouraged an informal life-style that began to take root in American society after World War I. Enclosing the porch are thick, tapered square columns that are made of wood, concrete or masonry. Railing and balustrade (an extension of the foundation masonry piers) are sometimes used. The exterior walls are most commonly wood siding and clapboard. Windows and door are made of wood and are either double-hung or casement sash. The wood

doors are simple and are often with panes of glass, and the windows are often grouped in clusters of two or three windows and can be single-pane (lower sashes), or 2- or 4-pane (upper sashes).

Bungalow roofs are typically constructed from one of two types of materials - shingles or metal panels. Each Bungalow has a chimney made out of brick topped with a decorative cap. Rake beams sometimes extend from the wall to the roof overhang and are supported by knee braces, while decorative and ornamented rafters extend beyond the face of the wall. Multiple roof configurations are typically utilized. The first roof type is a hip roof over one or one-and-a-half story, with a low dormer on the main façade; the second has one or more gables perpendicular to the street, with one being the most dominant, usually above the porch; the third roof type has a gable parallel to the street with a cross gable intersecting, typically covering the front porch and entrance; and the fourth type is a large one-and-a-half story home with a gable parallel to the street which incorporates a dormer.



Figure 5.6: Bungalow / Craftsman Facade Features



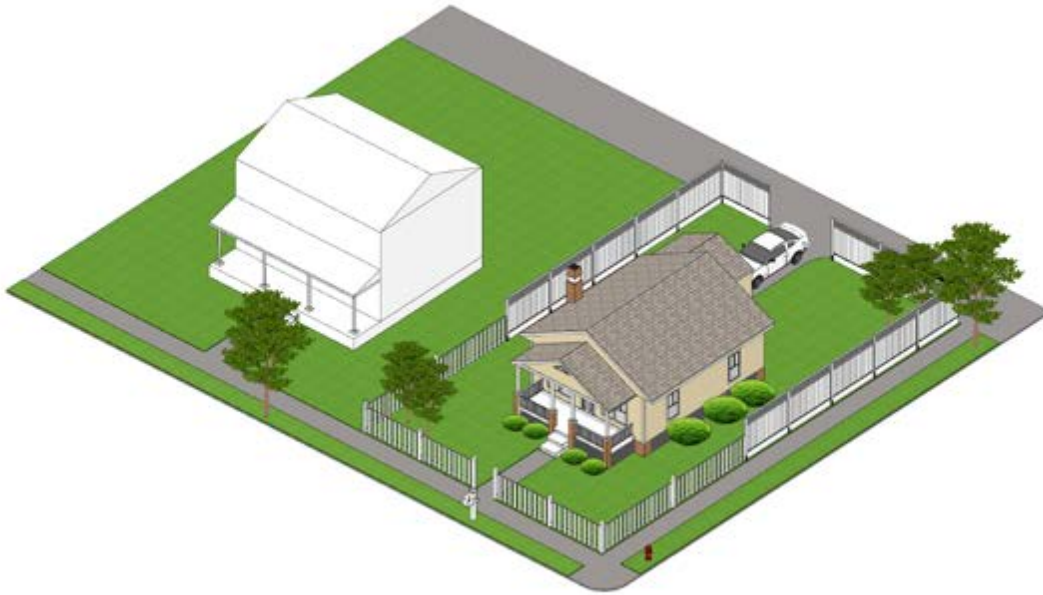

Figure 5.7: Bungalow / Craftsman House Style and Neighborhood Context

The Bungalow is the most prevalent historic house style in the city’s six residential historic districts. When first introduced, the Bungalow was the “standard” single-family structure for fast-growing residential neighborhoods throughout the city. Today,

the many Bungalow variations of one and two-story masses often modulate the overall form of the street, while their horizontal massing proportions and façade compositions contribute to the visual rhythm of the block face.



5.4 MEDITERRANEAN REVIVAL/SPANISH COLONIAL



Figure 5.8: Facade Conditions from Mediterranean Revival / Spanish Colonial House Styles

Found in those states with a Spanish colonial heritage, Mediterranean Revival contains architectural elements from Spain and the Middle East. Mediterranean Revival was a popular building style in Florida in the 1920s and 1930s. It was adapted for a variety of building types, ranging from grandiose tourist hotels to two-room residences. Many commercial and residential buildings underwent renovation in the 1920s, to reflect the Mediterranean influence. The floor plan is typically rectangular with an extension on either the side of the front walls to accommodate an arcaded entrance or porch. A Mediterranean Revival structure will range from one to two stories and is supported by a continuous

concrete and stem wall footing. The front porch will typically have a flat roof and be supported by square columns. The exterior surfaces are usually stucco with the windows and doors being framed with decorative wood or iron grills. The building is typically ornamented with wrought iron grill work, small second-story balconies, and ceramic tile decoration. The Mediterranean Revival has a low-pitched or flat roof typically paired with some form of a parapet with the most dominant characteristic being the ceramic tile roof, also known as clay roof tiles. The tiles are usually hung in parallel rows, with each row overlapping the row below it to exclude rain-water and to cover the nails that hold the row below.





Figure 5.9: Mediterranean Revival / Spanish Colonial Facade Features



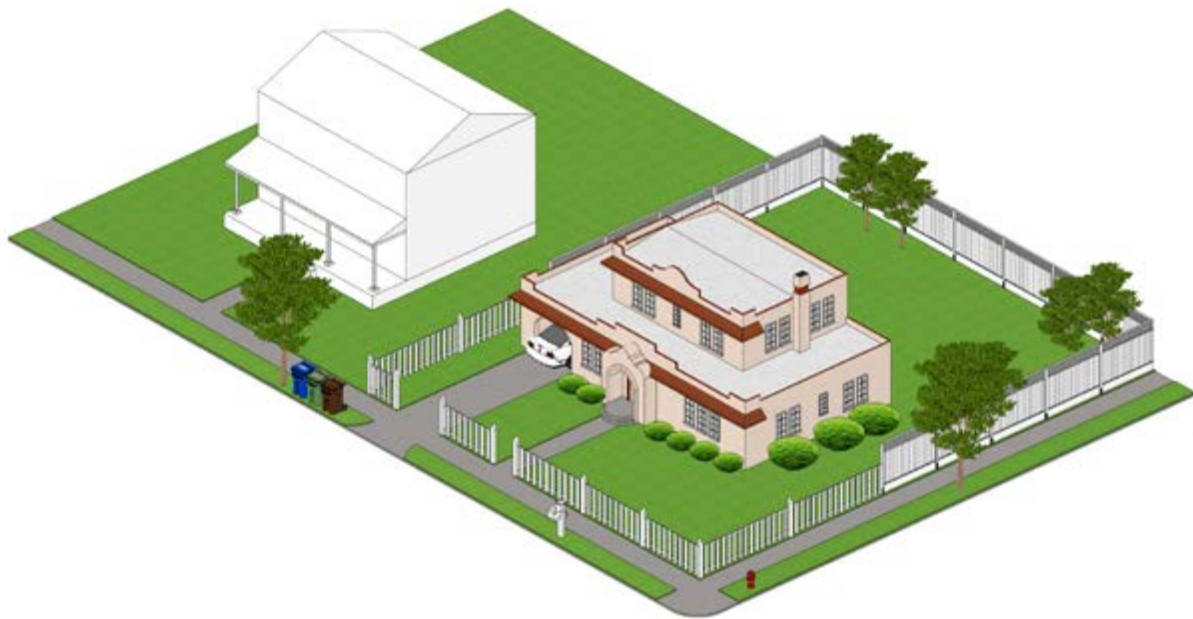

Figure 5.10: Mediterranean Revival / Spanish Colonial House and Neighborhood Context

Mediterranean Revival houses combine a number of different architectural features to make a visual statement along the street. Their simple geometric massing serves as a palette for ornamentation of the roof parapet, entryway, doors and windows - all meant to enhance the visual character of the main

façade. This house style was popular throughout the State prior to and during Florida’s Land Boom years of the 1920s. The many features from traditional Spanish architecture that define this style have contributed countless architectural interpretations in both size and configuration.



5.5 COLONIAL REVIVAL



Figure 5.11: Facade Conditions from Colonial Revival House Styles

The Colonial Revival style was introduced at the Philadelphia Exposition of 1876. This celebration of the centennial of the United States fueled a nostalgia for early America and sparked a renewed interest in the architecture of the colonial period. There are three basic types of Colonial Revival buildings: the historically accurate reproduction of 17th century Georgian and Federal styles; the Colonial or Classical elements applied to Victorian or Post-Victorian buildings, and lastly, simple vernacular homes with Colonial details. The typical Colonial Revival house in Florida, which emerged in the late 1880s, is a mix of several colonial designs rather than a direct copy of a single style. Colonial Revival is typically two stories with a front porch stretching the length of the building or simple entry porches (some buildings may have porches in the rear). The façade is symmetrical with an entrance stair centered on the main façade and classical columns spaced evenly across the front. Like other

historic structures, the Colonial Revival is supported by brick (earlier periods) or concrete (later periods) piers that are spaced out to allow for ventilation and for protection from high water. The exterior is typically made of horizontal wood siding and is decorated with pediments, broken pediments, and wood shutters. The doors have a simple classical trim and are often flanked by fixed glass sidelights. The windows have simple trims and are sometimes framed by wooden or wrought iron grills. The windows are paired double-hung wood sash with 6/6 or 2/2 divided panes. Colonial Revival either has a gable, hip, or gambrel primary roof with the porch roof being a shed or low-sloped configuration. Dormers with hip, gable or shed roofs are a defining characteristic with rafter ends typically exposed and decoratively cut. The roof is covered with composition shingles or occasionally metal roof coverings. All chimneys are brick with simple coursing, shoulder and corbel details.



Figure 5.12: Colonial Revival Facade Features



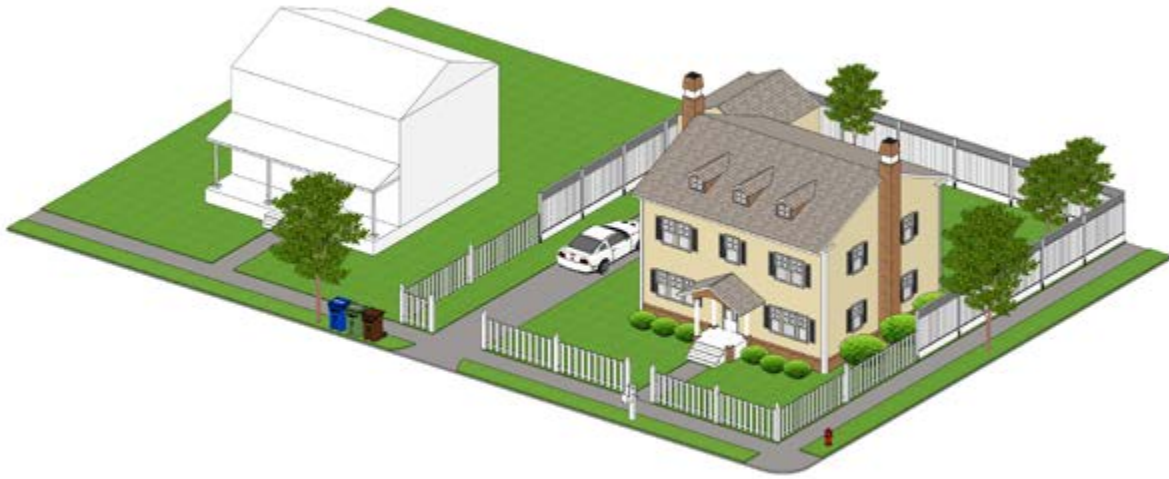

Figure 5.13: Colonial Revival House and Neighborhood Context

The Colonial Revival house style and its many variations were the main house styles used in emerging communities throughout the country, from the 1880s to the early 1950s. The broad two-story front façade and its symmetrical, stately proportions gives this

house style a commanding presence along the block face. This is one of few historic house styles that has evolved throughout much of the twentieth century and continues to influence form and character of contemporary neighborhoods.



5.6 QUEEN ANNE



Figure 5.14: Facade Conditions from Queen Anne House Styles

The Queen Anne style was initially inspired by English country cottages of the late Medieval period, and is named for an 18th century English queen. A group of English architects were primarily responsible for the popularity of this style in the late nineteenth century. Queen Anne buildings are highly decorative, often combining a variety of colors and textures. The emphasis on decorative details, vertical orientation, and asymmetrical layouts encouraged individualistic and free-flowing designs. A Queen Anne can range from two to three-and-a-half stories and has an asymmetrical plan. It is typically supported by brick (earlier periods) or concrete (later periods) piers that are spaced out to allow for ventilation and for protection from high water. The porch is intended to accentuate the characteristic asymmetrical façade and can partially or fully stretch across the façade. Simple, classical columns are sometimes grouped and raised to the railing level with pedestals. The railings are un-decorative and simple. The exterior of a Queen Anne is usually horizontal wood siding but can sometimes have

a combination of shingles, clapboard, and decorative wood panels on one house. The house is often decorated with shingle patterns in the gable ends, decorative bargeboards, sunburst detailing, triangular pediments or iron roof cresting. Windows may be a mixture of sizes and shapes and are typically double-hung wood sash windows with single and divided panes. Windows commonly have decorative glass, such as diamond-shaped panes, and are detailed with simple surrounds. Doors have decorative carvings and details often with glass panes in the upper part of the door. The roof of a Queen Anne is a steeply-pitched main hipped roof with one or more lower cross gables; occasionally a pyramidal roof with no ridge, or a small flat deck crowning the main hip roof. Typically placed at one corner of the front façade are polygonal towers with a conical roof. There are multiple dormers and gables present with metal or composition shingles covering the roof. All Queen Anne homes have brick chimneys with decorative patterns or coursing, decorated chimney caps.



Figure 5.15: Queen Anne Facade Features





Figure 5.16: Queen Anne House and Neighborhood Context

The Queen Anne house style proliferated throughout the country during the last two decades of the nineteenth century. It is largely associated with the expansion of the railroad – which made pre-cut building materials available through the use of pattern books and mail order house kits. This house style

was chosen for its “fanciful” architectural character and was often situated on corner or other prominent sites. During its short period of construction, the Queen Anne house style became the “grand dame” of neighborhood development because of its prestige and visual prominence.



5.7 FOUR SQUARE



Figure 5.17: Facade Conditions from Four Square House Styles

The American Foursquare, sometimes called the “Prairie Box”, was a widely popular architectural style in almost every part of the country. After 1900, it was one of the most popular house styles in both rural settings and on small city lots. Its efficient layout fit perfectly onto the compact lots of growing city neighborhoods as Americans moved from rural areas to cities for the new manufacturing jobs of the time. They were sensible two- to two-and-a-half-story homes that were economical to build, comfortable to live in, and aesthetically pleasing in their simplicity. The American Four Square showed a tendency toward a narrower front and back with longer sides to fill the site. It takes its name from its simple, cubic shape and floor plan which is divided into quarters on each floor. It is typically supported by a fully enclosed raised masonry, stone, or brick foundation with pierced openings to allow for ventilation

and for protection from high water. The Four Square has a symmetrical façade, sometimes with an offset porch. The porch is always accessed by wide entry stairs and runs the full width of the house with classical, rectangular columns under a hipped-roof with wide overhangs. The exterior can be found in many different materials and sometimes in combination of horizontal wood siding, brick, stone, stucco, shingle, clapboard siding. The house features simple, double-hung, often irregularly shaped windows with a sheet of plain glass for the lower portion and, a grouping of smaller panes united in a single frame divided by thin mullions for the upper portion. The roof configuration of the typical Four Square house is a combination of hipped planes that result in a pyramidal shape. Other characteristics of this roof type include wide or deep overhangs and a large, hipped central dormer facing the front.



Figure 5.18: Four Square Facade Features



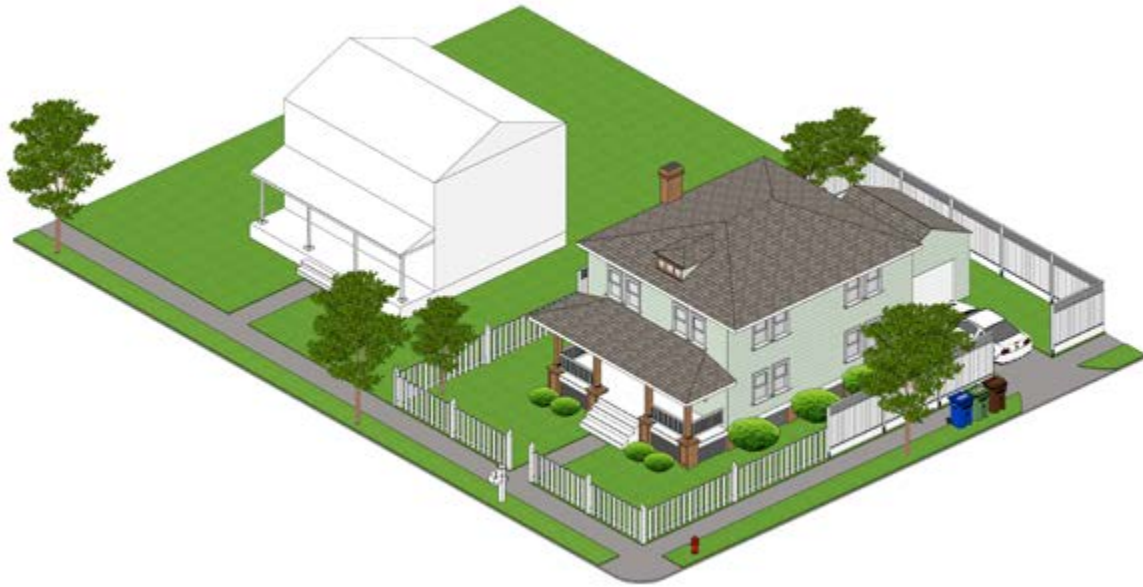

Figure 5.19: Four Square House and Neighborhood Context

The Foursquare was the first Prairie house style that emerged in the mid-west during the late nineteenth century. This house style was developed as a plain, more affordable alternative to the more ornate houses built during this era and better suited for narrow

lots. The Foursquare was popular in communities where the railroads had a presence because they could be delivered to a community as mail-order kit houses. Today, these house styles exist in various forms in all of the City’s residential historic districts.



5.8 GREEK REVIVAL



Figure 5.20: Facade Conditions from Greek Revival House Style

Greek Revival was the dominant architectural style in the United States between 1830 and 1860 and even became known as the national style, with the most notable feature being the temple-fronted façades on the nation's churches, banks, town halls, and houses. Greek Revival houses have a regular rectangular plan and are typically one to two-and-one-half stories in height supported by brick piers that are spaced out to allow for ventilation and for protection from high water. The façade is symmetrical with windows evenly placed and either a single or double height full width porch with wood columns without bases and are fluted or smooth. The exterior can be stucco, wood, and occasionally stone to resemble the construction of temples. The buildings were usually painted white or enhanced

with a faux finish. The windows are mostly double hung with six panes to each sash. Decorative windows were frequently in three-part assemblages and among the style's unique features are the small rectangular windows set into the frieze beneath the cornice that replaced the common dormer. Window surrounds tended to be less elaborate than doorways. The doors, single or double, divided into one, two, or four panels, have elaborate surrounds with small-paned sidelights and a rectangular transom framed by heavy, wide trim, and sometimes recessed. The Greek Revival roof is typically a low-pitched gable with a hip. The cornice line is typically embellished with a wide band of trim to resemble a temple-like roof. The roof is covered with standing seam tin or cedar shingles.



Figure 5.21: Greek Revival Facade Features



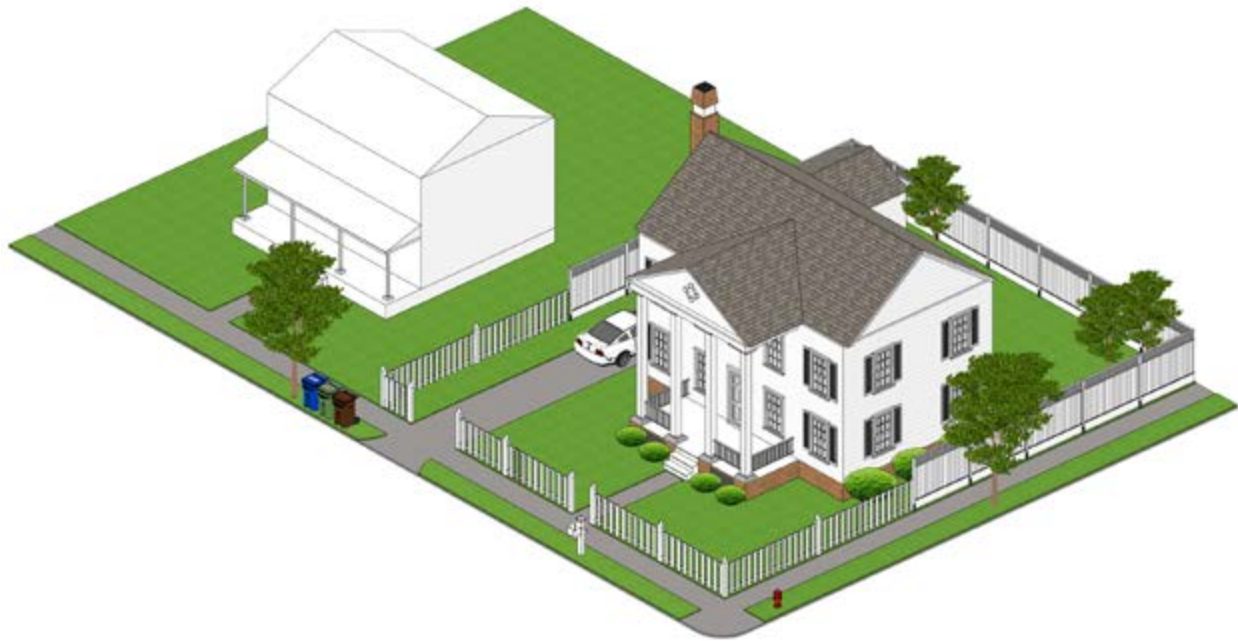

Figure 5.22: Greek Revival House and Neighborhood Context



5.9 NEO-CLASSICAL



Figure 5.23: Facade Conditions from Neo-Classical House Style

The Neoclassical style emerged in the mid-18th century as a reaction to the decorative Baroque and Rococo styles. Neoclassical architecture has an uncluttered and balanced aesthetic, characterized by grandeur of scale, simplicity of geometric forms, Greek or Roman detail, dramatic use of columns, and a preference for blank walls. A Neo-Classical home is typically 1 to 2 1/2 stories with a roof supported by classical columns, often fluted, fronting the building. The typical style has a two-story porch, with symmetry exhibited by balanced

windows and a centered door. The doorways often have decorative surrounds and fan lights above the entranceway, while the windows have double-hung sashes, most often divided into six or eight panes. The windows are always evenly spaced across the home's facade and typically flanked by shutters. The roof is typically low-pitched or flat with a balustrade and the building is ornamented by broken or unbroken pediments and side lights surrounding the entry. Classical detailing at the eave is common with embellishments like modillions or dentil molding.





Figure 5.24: Neo-Classical Facade Features



Figure 5.25: Neo-Classical House and Neighborhood Context



5.10 MODERN

Not much construction of residential homes occurred in the Country during the Depression. When construction resumed in the late forties, Modern styles were preferred over the classical styles. The earliest Modern style used was the Minimal Traditional, a simplified form loosely based on the Tudor style of the 1920s and 1930s. By the early 1950s, this style started being replaced by the Ranch style, which dominated American domestic building through the 1960s and is still popular in many parts of the country. Other styles observed during this period included the Contemporary and Split Level. Locally, there were other variations of these Modern styles, which, for the purposes of this document, will be called Modern Masonry Vernacular and Modern Frame Vernacular. The Modern Vernacular style still represents the common wood (or masonry)

frame construction technique employed by lay or self-taught builders.

The first Modern styles show a transition from the craftsman-built homes to a mass production building process. With the development of the cement asbestos material for siding and roofing, and the hollow concrete structural blocks and fired clay tiles (lighter and less expensive than fired brick or stone), construction became more affordable. The Modern period brought in a combination of affordable wood frame and masonry construction.

This section describes the various Modern styles appropriate for the Biltmore Cumberland Neighborhood: Minimal Traditional, Hip Cottage, Ranch, and Modern Vernacular (Frame and Masonry).



Figure 5.26: Minimal Traditional



Figure 5.27: Hip Cottage



Figure 5.28: Ranch



Figure 5.29: Modern Vernacular (Frame and Masonry)

5.10.1 MODERN/MINIMAL TRADITIONAL



Figure 5.30: Facade Conditions from Modern / Minimal Traditional Style

The Minimal Traditional is an early Modern Style loosely based on the Tudor style of the 1920s and 1930s. The predominant features of this style include a dominant front gable and massive chimneys;

although the use of chimneys was not as popular in Florida as it was in northern states. The roof pitch is lower than in previous styles and the facades were simplified by omitting most of the detailing.



Plans

- Irregular, compact form
- Front displays protruding volume (front gable)
- Form following function
- Usually one story with floors above grade
- Ceiling heights reduced to 8 feet
- One-car carport or garage setback from main façade (attached or detached)

Foundations

- Raised masonry (usually block), fully enclosed
- Pierced openings in the foundation to allow for ventilation

Porches and Facades

- Asymmetric facade
- Sometimes tongue and groove siding on gable ends; dog-ear detail on bottom of siding
- De-emphasis or lack of articulation at main entrance
- Small portico instead of wide porch common prior to this period. Usually to the side of the front gable volume, or integrated into the volume
- Wrought iron or simple wood porch supports, often with railings
- Concrete porch surface
- Porch roof is usually extended gable
- Subdued colors. Usually two colors used for main body and another for trims

Roofs

- Cross gable with one protruding front facing gable
- Low or intermediate pitch
- Eaves and rakes are close rather than overhanging
- Asphalt shingles
- Simple attic vents in gable ends

Exterior

- Locally, asbestos siding and painted concrete block
- Wood frame buildings sometimes have a masonry

(concrete block) carport/garage

- Rounded edges on concrete block (see Figure 5.31)

Windows and Doors

- Predominantly steel casement windows, or combination of picture and casement
- Some awning windows with louvers in kitchen, bathroom or sunroom areas
- Windows and doors placed just below the eave line
- Solid wood doors, sometimes with a small window on top half
- Sometimes combination of wood or metal and louver window

Exterior Decoration

- Lack of ornamentation
- Decorative shutters, some with cut-out shapes

Garages and Carports

- Earlier buildings have carports
- Garages and carports are secondary to the main building/facade. They are either recessed from main façade or detached and placed in the rear.
- Normally one-car space only. Very few examples have a double car garage, and in those cases, there are two doors, instead of a double-wide door.
- Some carports have been enclosed for use as garages.



Figure 5.31: Concrete Block with Rounded Edges

5.10.2 MODERN/HIP COTTAGE



Figure 5.32: Facade Conditions from Modern / Hip Cottage Styles

There are several homes in Lakeland that are a mix between the Ranch and Minimal Traditional style. For the purpose of this document, they have been classified as Modern/Hip Cottage. They have similar plans, scale, orientation and massing to the Minimal Traditional homes, but instead of the dominant gable front they have a hip roof on that wing.

They do not belong in the Ranch group either because their floor plans seem more compact, less horizontal. They were not grouped with the Vernacular styles because of the amount of homes with the same stylistic features, not only in Lakeland but also in other Florida cities.



Plans

- Irregular, compact form
- Front displays protruding volume with hip roof
- Form following function
- Usually one story with floors above grade
- Ceiling heights reduced to 8 feet
- One-car carport or garage setback from main façade (attached or detached)

Foundations

- Raised masonry (usually block), fully enclosed
- Pierced openings in the foundation to allow for ventilation

Porches and Facades

- Asymmetric facade
- De-emphasis or lack of articulation at main entrance
- Small portico instead of wide porch common prior to this period. Usually to the side of the hip volume
- Wrought iron or simple wood porch supports
- Concrete porch surface
- Porch roof is usually extended gable
- Subdued colors (Usually two colors used for main body and another for trims)

Roofs

- Hip
- Intermediate pitched roofs
- Moderate or wide overhang
- Asphalt shingles

Exterior

- Locally, asbestos siding or painted concrete block

Windows and Doors

- Predominantly steel casement windows, or combination of picture and casement
- Some awning windows with louver in kitchen, bathroom or sunroom areas
- Windows and doors placed just below the eave line
- Corner windows
- Solid wood doors, sometimes with small window on top half

Exterior Decoration

- Lack of ornamentation
- Decorative shutters, some with cutout shapes
- Concrete or brick window sills

Garages and Carports

- Earlier buildings have detached carports
- Garages and carports are secondary to the main building/facade. They are either recessed from main façade or detached and placed in the rear.
- Normally one-car space only. Very few examples have a double car garage, and in those cases, there are two doors, instead of a double-wide door.

5.10.3 MODERN/RANCH

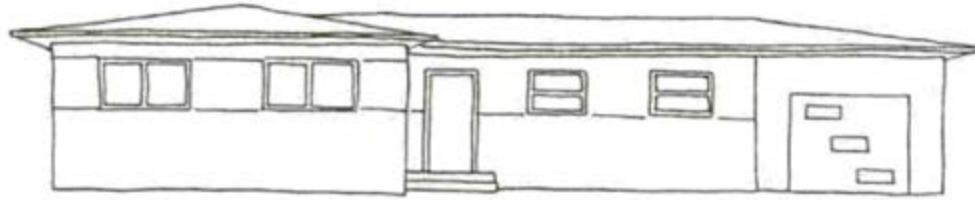

Figure 5.33: Facade Conditions from Modern / Ranch Styles

The Ranch style dominated American domestic building through the 1960s and is still popular in many parts of the country. Ranch houses stressed three basic concepts: livability, flexibility and unpretentious character.

Ranch houses are one-story houses with very low-pitched roofs and broad, rambling facades. Some lack decorative detailing, but most have decorative shutters, porch-roof supports, and other detailing, loosely based on colonial precedents. Outdoor living areas extending beyond the house on the same level were also emphasized, so that interior space merged with the exterior, separated merely by large areas of glass and sliding glass doors. Other typical characteristics included a linear arrangement of rooms, elevations composed asymmetrically, and a telescopic effect of low wings spreading out from the rectangular core of the plan. Additions and alterations to a ranch house were foreseeable since

they were part of its architectural tradition. Picture windows, broad chimneys (not so much in Florida), horizontal bands of windows, and exterior terraces or patios became distinguishing features of the forward-looking yet lower-cost suburban home.

There are several Ranch homes in Lakeland without the projecting and receding planes of the typical rambler facades. The floor plan is rather rectangular, and is usually less "high-style" in character. The facade usually has a large picture window on one side of the front door, with one or two short banks of ribbon windows on the other side of the door. Occasionally, picture windows will be located on both sides of the front door. The rectangular ranch often does not have an integrated garage, and when it does occur, it is often attached to the rear as opposed to the prominent location on the front of the house, as seen with the rambler.



Plans

- One-story
- Built-in garages are an integral part of the house, generally in line with main façade
- Generally rectangular, elongated form maximizes lot width; may or may not incorporate a cross gable
- Usually one story
- Ceiling heights reduced to 8 feet

Foundations

- Most homes built at grade, or with minimal elevation.
- Slab with poured concrete footings. Most local examples have raised masonry foundation (usually block).
- Pierced openings in the foundation to allow for ventilation

Porches and Facades

- Asymmetrical façade, except on duplex buildings
- Wide facades, further increased by the built-in garages
- De-emphasis or lack of articulation at main entrance
- Integral/incised small porches, or small porticos/stubs in the less elaborate examples
- Wrought iron or simple wood porch supports
- Concrete porch surface
- Porch roof is usually extended gable or integral
- Subdued colors (usually two colors used for main body and another for trims)

Roofs

- Low pitched roofs
- Moderate or wide eave overhang; either boxed or open, with the rafters exposed
- Three common roof forms used: the hipped version is probably the most common, followed by the cross-gabled, and, finally, side-gabled examples
- Asphalt shingles

Exterior

- Wood and brick wall cladding are used, sometimes in combination; locally, asbestos siding and painted concrete block are also used

Windows and Doors

- Large picture windows in living areas
- Ribbon windows
- Predominantly steel casement windows, or combination of picture and casement
- Some awning windows with louver in kitchen, bathroom or sunroom areas
- Windows and doors placed just below the eave line
- Solid wood doors with no detailing

Exterior Decoration

- Some include modest bits of traditional detailing, usually loosely based on Spanish or English Colonial precedents
- Decorative iron or wooden porch supports
- Decorative shutters, some with cutout shapes

Garages and Carports

- Garages and carports are in line with the main facade
- One or two-car garages; two doors, instead of a double-wide door

5.10.4 MODERN VERNACULAR (FRAME AND MASONRY)

Vernacular architecture refers to a regional or “folk” architecture, built with local materials and local labor, without formal plans, and for the most economical price at the time. The Vernacular, while considered a style, is defined by its not belonging to any particular formal architectural style. Frame Vernacular was typical of the period before the Great Depression, when the classical styles were predominant and the Frame Vernacular was loosely based on those styles, or a combination of them. The Frame Vernacular of the period following the Depression represents the basic construction of the time, when the goal was to produce low cost, flexible, expandable, comfortable, and unpretentious buildings. Ideals emphasizing simplicity and efficiency called for house designs that reflected less hierarchical relationships, technological innovations, and a more informal and relaxed lifestyle. Designed to be small but expandable, the houses built from the early 1930s through the 1950s have typically been enlarged as homeowners have added garages, porches, sunrooms, family rooms, and additional bedrooms.

Builders of middle and upper income homes mimicked the architect-designed homes of the southwest, offering innovations such as sliding glass doors, picture windows, carports, screens of decorative blocks, and exposed timbers and beams, which derived as much from modernistic influences as those of traditional southwestern design. These one-story vernacular homes generally have low-pitched roofs, a small entrance porch at the front door, and minimal decorative architectural details. Enclosed, raised masonry foundations with minimal ventilation are typical. Steel casement windows replaced wood and permitted wider expanses of windows. In Lakeland, the Masonry Vernacular style often makes use of locally produced rusticated concrete block known as “Ocala” block.

The Masonry Vernacular style in Lakeland also depicts a slight influence from the Art Deco style popular in Florida in the 1930s. Some of the borrowed features include the screen blocks (blocks with patterned holes), metal awnings, colors, decorative shutters done in masonry, and matching masonry planters adjacent to the building.



Plans

- Usually rectangular or square, or long, low forms sometimes made up of a series of “box” shapes
- Usually one-story with floors above grade
- Ceiling heights reduced to 8 feet
- Single car garage set back from main façade

Foundations

- Raised masonry (usually block), fully enclosed
- Pierced openings (cinder block placed sideways) in the foundation to allow for ventilation

Porches and Facades

- Small, simple entrance porches
- Wrought iron or simple wood supports (not columns), in most cases with railings
- Porch surface of concrete or broken quarry tile
- Porch roofs that are hip, gable, or shed
- Masonry walls with shadow blocks or “honeycomb” blocks to allow for ventilation

Roofs

- Long low-pitched roofs with side gables, or hip roofs
- Exposed unadorned rafter ends finished with a fascia board or enclosed with a continuous screen vent
- Simple wood vents in the gable ends
- Asphalt shingles

Exterior

- Concrete block construction
- Gable ends covered with tongue & groove siding, often with a tapered or dog-ear detail on the bottom of the board

Windows and Doors

- Most often: 3- or 4-pane metal casement windows
- Elongated horizontal windows placed just below the eave line
- Living room: generally, steel casement window unit with a fixed center pane
- Structurally supporting corner casement windows
- Solid wood entry doors
- Decorative wood screen doors with wrought iron designs
- Single panel metal overhead garage door

Exterior Decoration

- Minimal; some decorative or textured block often bracketing windows or doors to mimic shutters
- Matching block or brick planters against the building
- Decorative wrought iron or wood features on porches
- Metal awnings over windows
- Screen block walls used as an occasional architectural highlight

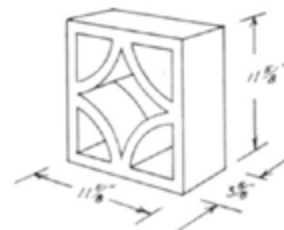

Figure 5.34: Screen Block Wall

5.11 TUDOR



Figure 5.35: Facade Conditions from Tudor House Style

A Tudor house possesses an eclectic style largely influenced by English architectural design from the sixteenth to the nineteenth centuries. The character of these houses is based on a combination of features loosely associated with English country cottages. This house style was popular throughout much of the United States from the 1920s to the 1930s. It was used for houses of varying size and often incorporated brick cladding and diverse roof combinations that gave it a sense of elegance. Its asymmetrical massing was another distinct

architectural condition. Tudor houses were often built with a steeply-pitched cross gable roof over the main part of the house, with a perpendicular gable over a smaller room extension facing the street. This feature usually created more architectural interest by using a type of roof called a “cat slide” – where one side of the gable is only one story in height, while the other is two stories in height. The main entrance would be located beneath this feature and was further emphasized with brick details and other ornamental elements.





Figure 5.36: Tudor Facade Features

Tudor houses were constructed in many parts of the United States during the early part of the twentieth century. Here, this house style was built as an interpretation of its traditional English cousin. It's often referred to as a “mock” Tudor or Tudor revival house style because some of these houses do not have the characteristic exposed timber framing members, or they use faux timber details. This house style blends some of the old-world features with modern building practices to create a distinctly unique variation.

Historic Tudor houses in Lakeland are characterized by their asymmetrical geometry, massing proportions and façade features. These houses typically have steeply pitched roofs and multiple gables. They incorporate basic rectangular geometry in one, two or three-story volumes. Cross gable roof configurations are common with this house style – usually with one main gable parallel with the street and a secondary gable facing the street. This smaller gable was often configured as a steeply pitched, gently

curving “cat slide” roof. This name comes from its slope configuration, which has one taller and shorter plane on one side and a longer plane on the other side usually covering a lower area. Portions of the roof may also extend outward to create porch areas on the ground floor.

Tudor houses are also recognized by their use of decorative brickwork and stone on the primary facades, occasionally with stucco and false half-timber insets. Entryways are typically a focal point the facades of Tudor houses. They are framed by covered openings that create small porch-like spaces in front of the main entry door. Windows on these houses are usually taller in shape and have glass panes with square or diamond-shaped divisions. Chimneys with ornate brick detailing is also a prominent feature of this house style. Lakeland’s residential historic districts have several examples of modest Tudor cottages that stand out along streets with other larger historic houses

5.12 OTHER UNIQUE STYLES

5.12.1 PRAIRIE



Figure 5.37: Facade Conditions from Prairie House Style

The Prairie house style originated in the Chicago area just after the turn of the twentieth-century and is largely credited to the architectural designs of Frank Lloyd Wright. Wright was interested in a type of house that was based on organic principles – an integration of structural and aesthetic beauty and human life. The formal properties of this house style were intended to have a direct relationship with the horizontal landform of the mid-western prairies. This house style was made popular through pattern books and magazines. Most Prairie style houses were built during a short period from 1900 to 1930, however this style began to fade after World War I.

Prairie style houses are typically two-stories with strong horizontal massing proportions. These features, along with their low hip roofs with broad overhangs and prominent porches made them ideal for the Florida climate and outdoor living. The facades of this house style are typically composed of grouped vertical windows, contrasting trim separating the two floors and large rectangular columns and piers across the front porch. The front porches of Prairie houses were most expressive architectural features. Details such as column variations, boxed eaves, wood siding, decorative windows and brick accents gave this house style a more contemporary expression and stately appearance facing the street.



5.12.2 DUTCH COLONIAL



Figure 5.38: Facade Conditions from Dutch Colonial House Style

The Dutch Colonial house style is primarily characterized by a broad, double-pitched gambrel roof. This feature commands visual attention because it has a fairly flat roof pitch at the top, which then changes angles and slopes almost straight down. This roof configuration is often accompanied by a wide second floor dormer extending across the front of the house, which is always narrower than the main façade. This design feature was ultimately classified as a one-story structure, allowing homeowners additional living space directly under the roof. Initially, it allowed some homeowners to get around paying taxes on a two-story structure.

This house style is considered a Revivalist subtype because of its resurgence in the early 1900s as Americans began to reconsider its colonial roots.

During this time, houses built in this style were typically built of wood, with clapboard, shingles and occasionally brick siding. Each facade of the Dutch Colonial house is typically symmetrical, except when a side or rear wing addition is present. This house usually has a fully exposed chimney at each gable end. Variations of this house style includes houses with full front porches. Other have small porches created by extending the eave out in front of the main part of the house creating a small overhead hood that was supported by decorative brackets or two columns at the edge of a stoop. Another distinguishing characteristic of this house style is its sparing use of ornamentation – except at the front entrance. The main entryway is the focal point of this house style. It often has a paneled front door, full-height side lights and surrounding wood trim.

The windows on this house are typical double-hung with multi-light sash variations with six-over-one, six-over-six, or eight-over-eight glass panes.

The Dutch Colonial was one of the most popular house styles during the 1920s. Several versions of

this house were offered as mail-order kit-houses from Sears Roebuck and Company during this time. This house style would fall out of favor during the 1930s as Americans began to embrace more modern house styles after the after the Great Depression.



6



EXTERIOR ARCHITECTURAL FEATURES: ALTERATION AND MAINTENANCE



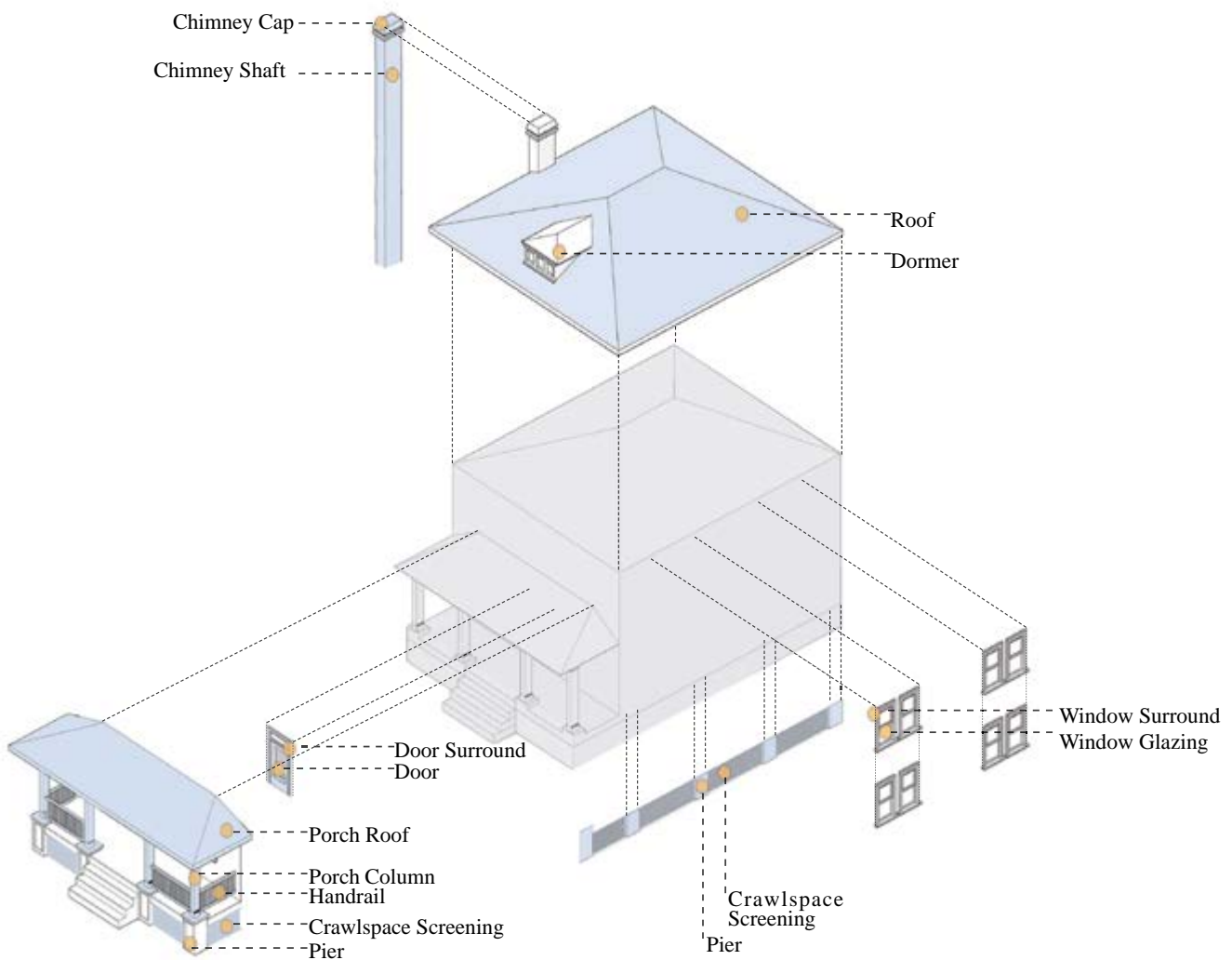

Figure 6.1: Exterior House Features and Details

Exterior architectural details are the individual features of historic houses that define their stylistic identity. Along with a home’s massing and materials combination, the composition and location of architectural details differentiates individual house styles in each of the City’s historic districts. For these houses, their architectural details convey a sense of

variety and originality. Maintaining these features in a manner that is compatible with the house style is essential to its long-term preservation. This section will describe the major features of historic houses and provide guidelines and recommended practices for each feature.

Principles for Normal Exterior Maintenance and Repair and Alterations

Routine Maintenance is Essential for Preservation

With proper maintenance, most historic buildings can last for centuries. Poorly functioning gutters, downspouts, and flashing; standing water at foundations; water splashing onto walls from the surrounding hard surfaces; and water-entrapping vegetation such as vines and shrubs on or near walls and foundations can all contribute to the deterioration of historic structures. Each of these issues can be prevented or corrected through proper maintenance.

Preservation of Features in Place is Preferred Over Replacement

Maintaining and repairing features is preferred over replacing features as to maintain the high-quality materials, character, and embodied energy of historic buildings and to reduce the amount of waste that goes to a landfill. However, if features are deteriorated beyond repair (more than 50%), in-kind

replacement using new components that match the original in form, finish, and materials is favored while replacement with comparable substitutes will be considered.

In Locations Not Visible from the Public Right-of-Way, Flexibility in Treatment and/or Replacement May be Considered

Building features not visible from the public right-of-way are less likely to detract from the character of the structure or district. More flexibility in the treatment and/or replacement of features in these locations may be considered if the historic integrity of the structure has already been lost or compromised and/or other unique circumstances exist that warrant consideration of a more flexible approach. However, proposed alterations will be reviewed on a case-by-case basis to determine whether they are appropriate.

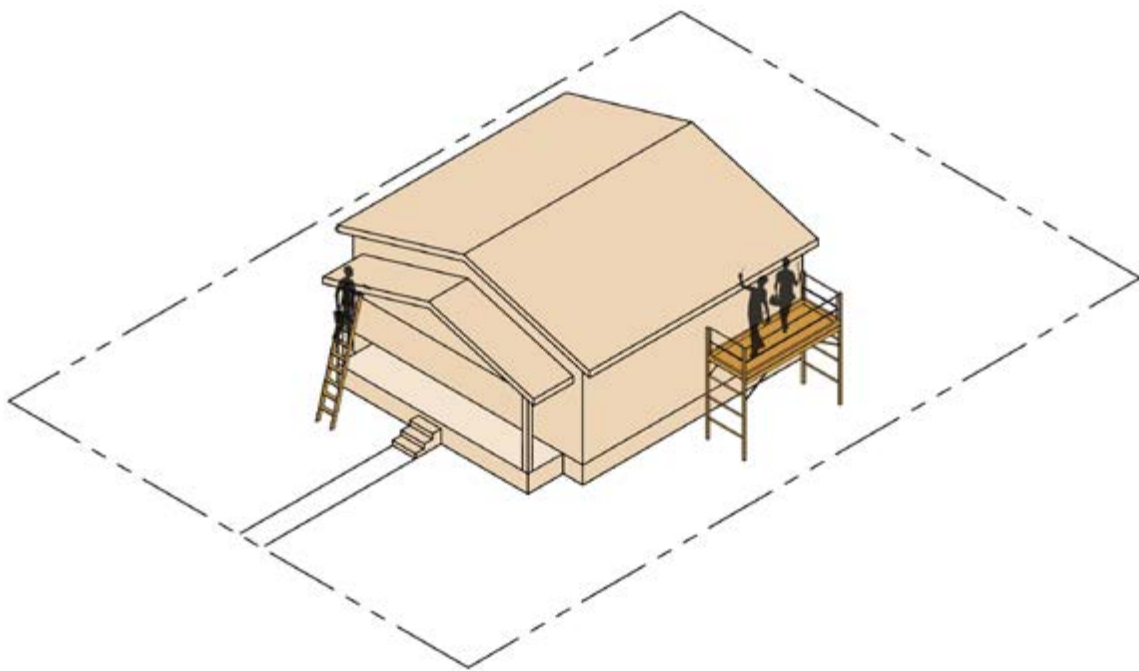

Figure 6.2: Maintenance, Repair and Alterations to Existing Historic House

GENERAL GUIDELINES

- Architectural details should be compatible with the architectural style of the building's original design.
- Protect existing architectural details, and retain distinctive features such as size, scale, mass, color, and materials of buildings, including roofs and porches that give the neighborhood its distinguishing character.
- Remove unsuitable or dilapidated sheds or garages (demolition permit required) if restoration or relocation is not possible.
- Retain the basic plan of the building.
- Repair or replace deteriorated material with new material that duplicates the old as nearly as possible. If the original detail cannot be maintained or replaced in its original form, it should be modified without disturbing the character of the structure.
- Align common elements, such as windows, doors, canopies, etc.
- Provide proper site and roof drainage to prevent water splashing against or draining toward the building.



6.1 ROOFS AND EAVES

Historic houses in the City’s six residential historic districts exhibit a range of different roof configurations. Although each roof configuration is influenced by the style or design of a building, they all serve a primary purpose – to protect the building from the elements. To do so, roofs typically incorporate a combination of sloped or flat planes to shed water away from the structure and provide shade over portions of the façades.

As a character-defining feature of historic buildings, the roof is one of the most important features to consider in preserving and maintaining a historic structure. It must continue to provide the same primary function over the life of the structure to retain its structural and aesthetic integrity. As the uppermost portion of the house, the configuration of the roof and its relationship to the main body of the house is visually prominent. Roof shapes should

complement the host structure with proportions that unify its overall massing composition. While roof materials may be replaced or changed during the extended life of the structure, roof configurations should not change. Extensive roof modification should never compete with other features of the house and should not alter the stylistic originality of the house. New roofs that are too steep or shallow in pitch relative to a particular house style, would detract from these conditions, look awkward or even overwhelm the original character of house.

In addition to the sloped surfaces, roofs also have a number of other smaller features that are part of the roof composition. These include features such as, chimneys, dormers, vertical projections, eaves, gable trim and other features that enhance the architectural character of the house.



6.1.1 FLAT ROOFS

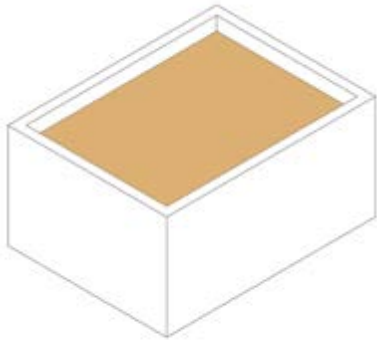

Flat Roof with a Parapet Wall

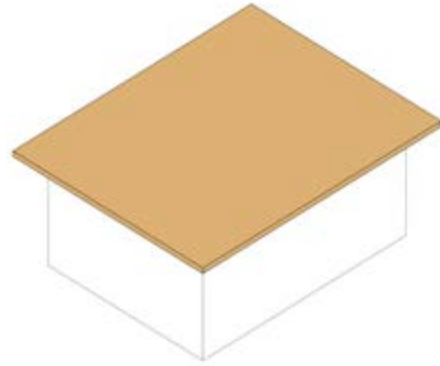

Flat Roof with Overhang

Figure 6.3: *Common Flat Roof Types*

Flat roofs on historic houses may be completely flat or have a slight pitch to help drain or divert water. On historic structures, flat roofs are most used on various types of Mediterranean or Spanish Revival house styles, as well as some Mid-Century Modern houses. Flat roofs are typically used in conjunction

with a parapet wall – a vertical extension of the house’s outer walls above the roof itself. This type of roof often incorporates smaller ornamental and decorative features as expressive architectural elements.



6.1.2 GABLE ROOFS

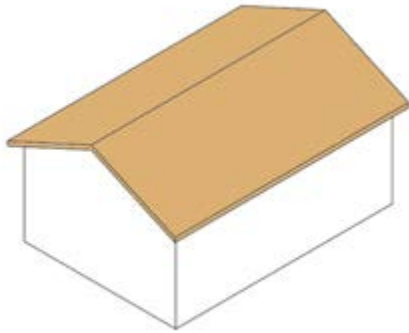

Front Gable

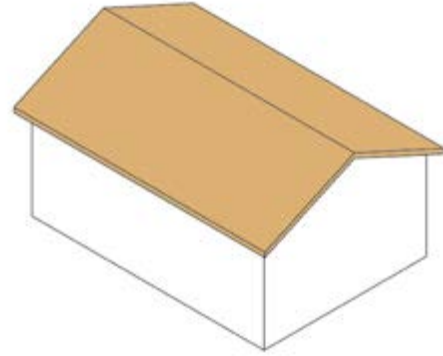

Side Gable

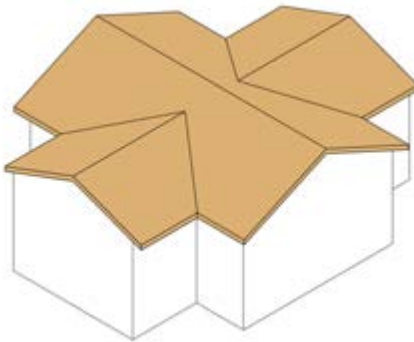

Cross Gable

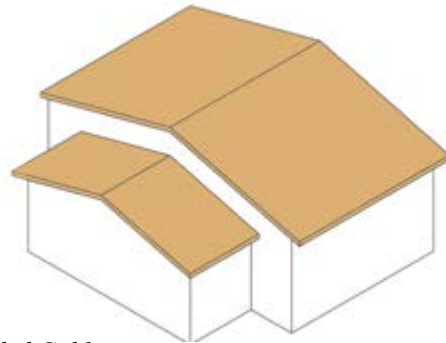

Extended Gable

Figure 6.4: *Common Gable Roof Types*

Gable roofs are the most common roof type seen on historic houses in Lakeland. They are easily recognized by two roof planes that slope in opposite directions, connected by a common ridge line that forms the roof's highest point. Gable roof profiles are efficient in diverting water away from the main

structure below and depending on their slope, gable roofs often provide interior attic space or additional interior extra space for the property owners.

This roof type can be configured in a variety of ways and combined with other roof types as well.



6.1.3 HIP ROOFS

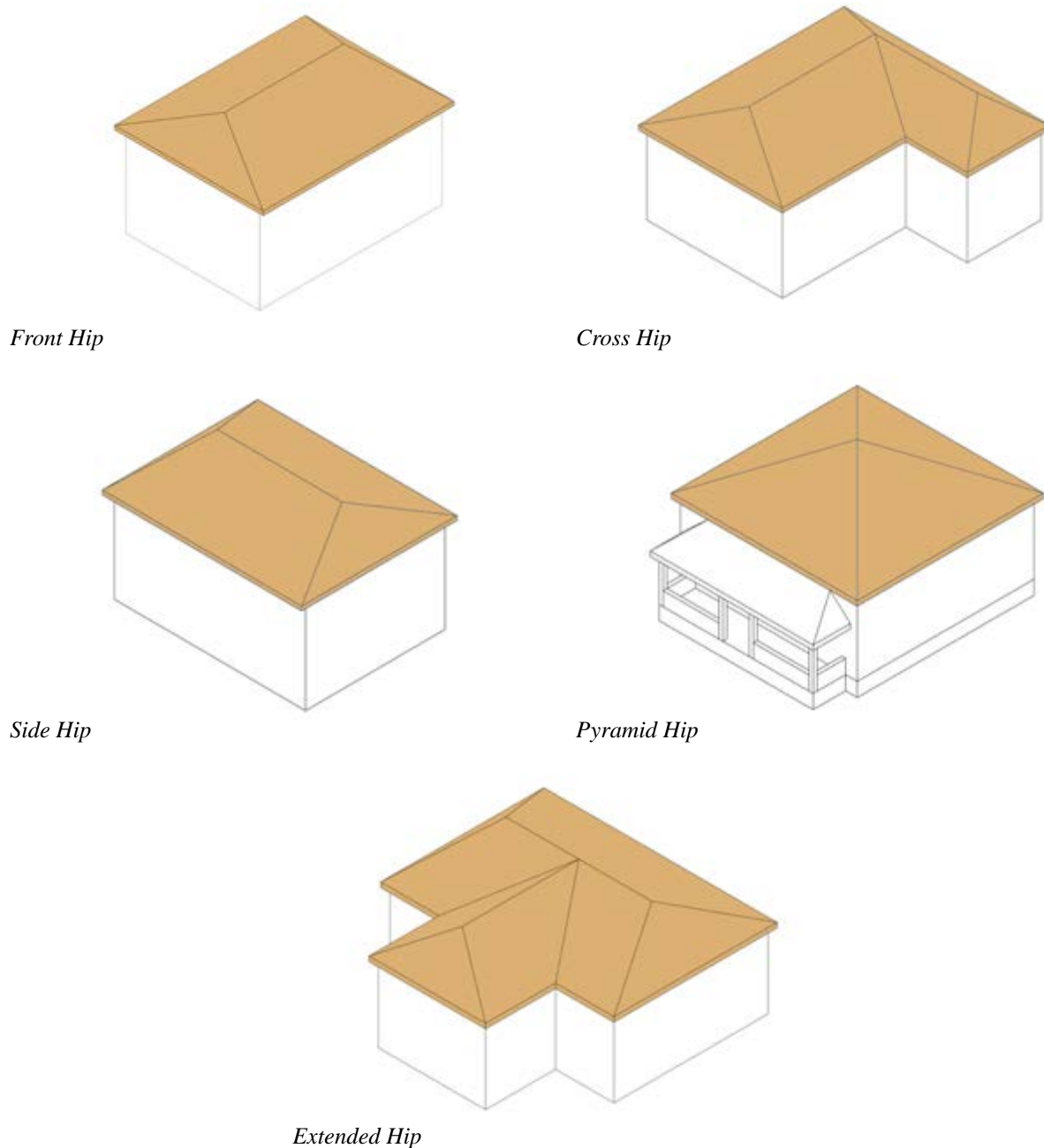

Figure 6.5: Common Hip Roof Types

Hip roofs are typically configured with opposing sets of sloping roof planes that converge at a common ridge line. While the slope of these roof planes vary depending on the architectural style of the house, they typically share a common eave and fascia at the base of the roof that extends around the

entire perimeter of the house. Hip roofs do not incorporate open gable ends.

With its four (or more) sloping roof planes, hip roofs incorporate more roof surface than gable roofs, but they divert rainwater away from all four sides of the

house, rather than just two. Hip roofs are considered more structurally stable in high wind events because all four sloped planes work together to facilitate

better airflow across the top of the house. Like gable roofs, hip roofs can assume a variety of configurations as well as be combined with other roof types.



6.1.4 OTHER COMMON ROOF TYPES

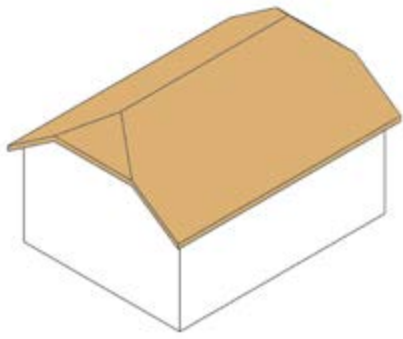

Gable/ Jerkinhead

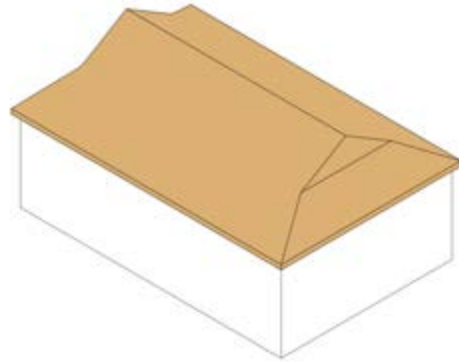

Gable on Hip

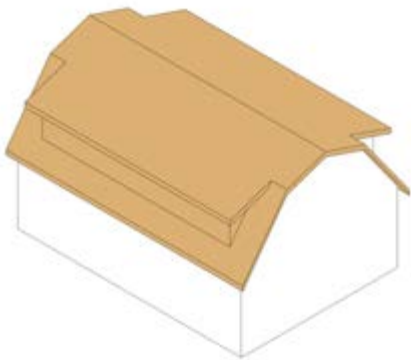

Gambrel

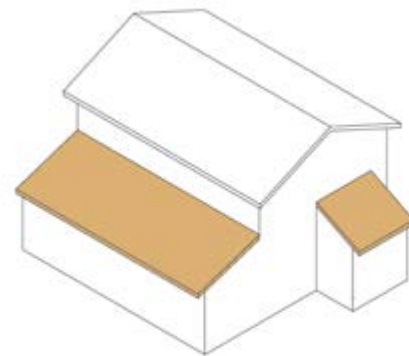

Lean-To or Shed Roof

Figure 6.6: Other Common Roof Types

These less common types of roofs can be seen on historic homes in Lakeland. While Hip on Gable and Gable on Hip roofs were built as aesthetic enhancements to traditional gable and hip types, Gambrel roofs are most commonly associated with the Dutch

Colonial architectural style. Except for some Mid-Century Modern house styles, shed roofs are not considered a primary roof type and are seen more often on porches or building additions.



6.1.5 ROOF MATERIALS

Roof materials vary from house to house in the City's historic districts. For the Central Florida Region, these most common roof materials include fiberglass or asphalt shingles, clay tiles and

metal panels. When installed properly, roof materials should complement the style of the house and contribute to its visual identity.

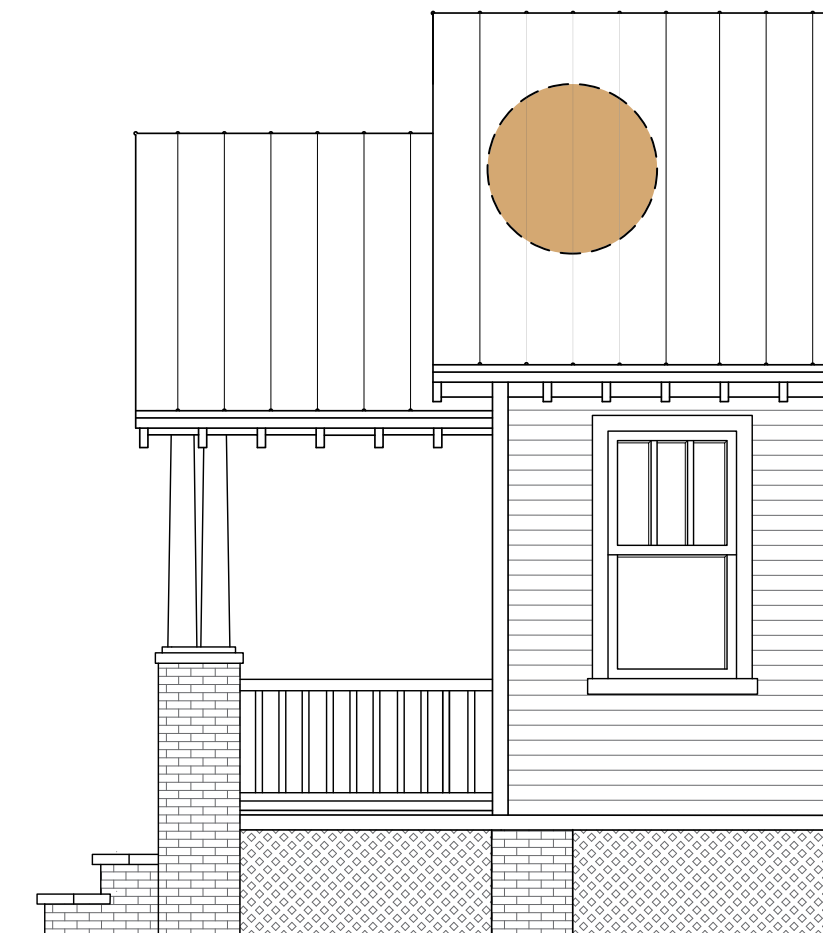
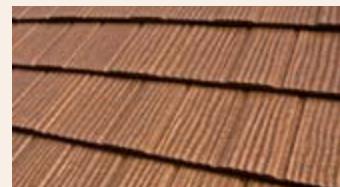

Figure 6.7: Roof Materials

Common Roof Materials on Historic Houses



Metal Shingles



Asphalt Shingles



Metal Panels



Barrel Clay Tiles



Asbestos Shingles

Metal Roofing Policy

**Historic Preservation Board,
Approved December 18, 2008**

The Historic Preservation Board's policy for roofing materials is based on the recommendations from the Secretary of Interior Standards for Rehabilitation Standards: 2, 4, 5, 6, 9 and Preservation Brief #4; *Model Guidelines for Design Review*, Division of Historical Resources, Florida Department of State, and *Traditional Construction Patterns: Design and Detail Rules-of-Thumb* by Stephen Mouzon and Susan Henderson.

The Secretary of Interior's Standards for Rehabilitation recommend that deteriorated roof surfacing should be replaced with matching materials or new materials in dark shades that match

the original in composition, size, shape, color, and texture. Replacement material must be compatible with the overall design of the building. Colonial Revival, Queen Anne, Frame Vernacular, Shotgun, and Craftsman Bungalows are appropriate styles of housing in Lakeland that are compatible with metal roofing material.

New materials, such as roll roofing, whose composition, size, shape, color, and texture alter the appearance of the building, are not recommended. The two acceptable metal roofing types are 5V crimp and flat-panel standing seam. Flat-panel standing seam roofing utilizing hidden fasteners should be installed in panels 16 to 18 inches wide. The seams should be as thin as possible (1/4 inch wide maximum) and as short as possible (1 1/2 inches tall maximum). Colors must be either plain metal or dark, subdued shades.



Guidelines for Preserving Roofs on Historic Houses



ACCEPTABLE

- Retention of original roof slope(s) and roof form.
- Retention of roof features that contribute to the architectural character of the house.
- Original dormers that are maintained as a character - defining architectural features.
- Replacement roof materials that are compatible with the design of the host structure.
- Retention of original chimneys.

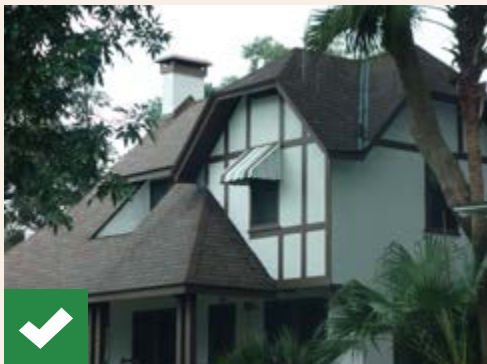

NOT ACCEPTABLE

- Alteration of original roof profiles.
- Roof materials that are incompatible with the architectural style and character of the structure.
- Removal or alterations of original dormer features.
- Removal of original chimneys that are structurally sound.



Recommended Best Practices for Maintaining and Preserving Roofs:

- Homeowners should perform regular inspections of roof materials that cover the entire house, as well as flashing along valleys and roof penetrations to identify signs of leaks, deterioration, or water damage underneath.
- When replacing a roof on a historic house, homeowners should replace roofing materials with similar or in-kind materials. Where there is a requested change in roofing material, consult Historic Preservation Board staff.
- Homeowners should refer the National Park Service’s Preservation Brief #4 - Roofing for Historic Buildings, Preservation Brief #30 - The Preservation and Repair of Historic Clay Tile Roofs and Preservation Brief #50 - Lightning Protection for Historic buildings for further guidance on maintaining and preserving roofs on historic houses.



6.1.6 CHIMNEYS

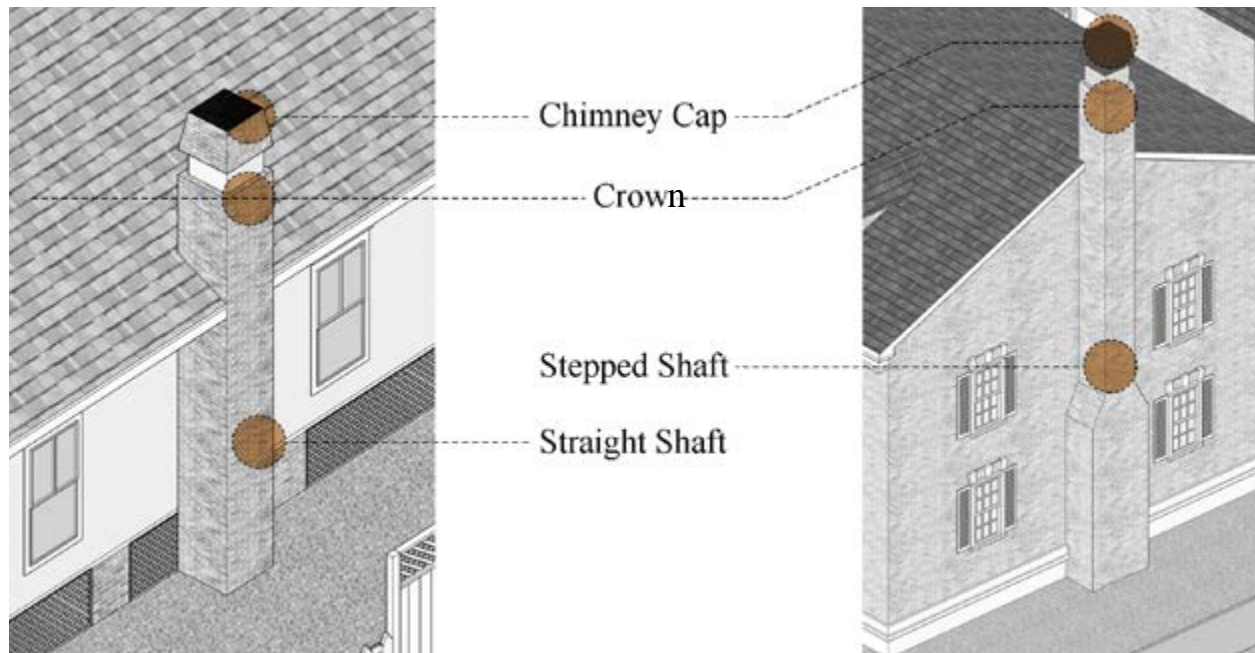

Figure 6.8: Fully Exposed Straight-Shaft and Stepped Masonry Chimneys

All historic houses in the City’s historic districts were built before technology advances such as central air and heat and relied on practical methods for interior thermal comfort. During cold-weather months, homeowners relied on one or more fireplaces. As such, historic houses tend to have one or more chimneys on their exterior walls or protruding through the roof. The shape, size and height of these chimneys becomes a part of the overall aesthetics of the house. In the City’s historic districts, some chimneys are fully visible on the exterior of the structures, from the ground up to the top. On other structures, the chimney may be more internal and only visible above the roof. Chimneys are typically rectangular, with straight vertical shafts, while others have a stepped, sloped or exhibit some other decorative features as they reach their ultimate height.

Chimneys are typically made of brick, stone and concrete - some with a stucco finish. Depending on the style of the house, some chimneys incorporate decorative brickwork, while others incorporate a

simple running bond brick pattern. When fully exposed on the façade of a house they become prominent architectural features as they extend above the roof and often contribute to the architectural character of different house styles. Parts of a chimney visible from the outside include: the base – typically a solid base material to support the chimney’s weight; the shaft – the vertical portion of the chimney; the crown – this is the feature at the top of the brickwork; the cap – the metal or clay flue that directs smoke from the very top of the chimney; and flashing – metal strips at the joint between the house and the chimney that provide a watertight closure.

While some chimneys may no longer be in use, they are part of the original structure’s design and should be maintained and preserved as significant architectural features. Some chimneys are totally or partially exposed to the elements and should be inspected on a regular basis to detect moisture infiltration, loose mortar and cracking. These conditions could lead to other problems in historic structures.

Guidelines for Preserving Chimneys on Historic Houses



ACCEPTABLE

- Retention of original chimney as a permanent architectural feature.
- Chimneys that are not altered or modified when not in use.



NOT ACCEPTABLE

- Alterations that change the character of original chimneys.
- Painting unpainted brick or stone chimneys.

Recommended Best Practices for Preserving Chimneys on Historic Houses:

- Homeowners should inspect the different parts of the chimney on a frequent basis to identify signs of weathering, settling, cracks, moisture damage, separation from the house and proper draw.
- Flashing at points where the chimney connects with or extends through the roof should be inspected to ensure its still intact and working properly to keep water out.
- Ensure that chimney caps are still intact and not cracked or damaged.
- Homes built before 1920 may not have a chimney flue liner. If not, homeowners should have a professional inspect this part of the chimney and have it cleaned to insure ongoing safe usage.
- Brick chimneys with efflorescence, the white powdery substance on the

surface, is a sign of moisture penetration. Homeowners should address this issue immediately by calling in a chimney professional. If this is a moderate condition, homeowners can remove it with appropriate cleaning agents and apply a waterproof sealer. Pressure washing to remove efflorescence is not recommended as it can further damage the chimney surface.

- Homeowners can refer to the National Park Service's Preservation Brief #1: [Assessing Cleaning and Water-Repellent Treatments for Historic Masonry Buildings](#) and [The Chimney Institute of America](#) for further guidance on maintain and preserving historic chimneys.

6.1.7 EAVES AND OVERHANGS

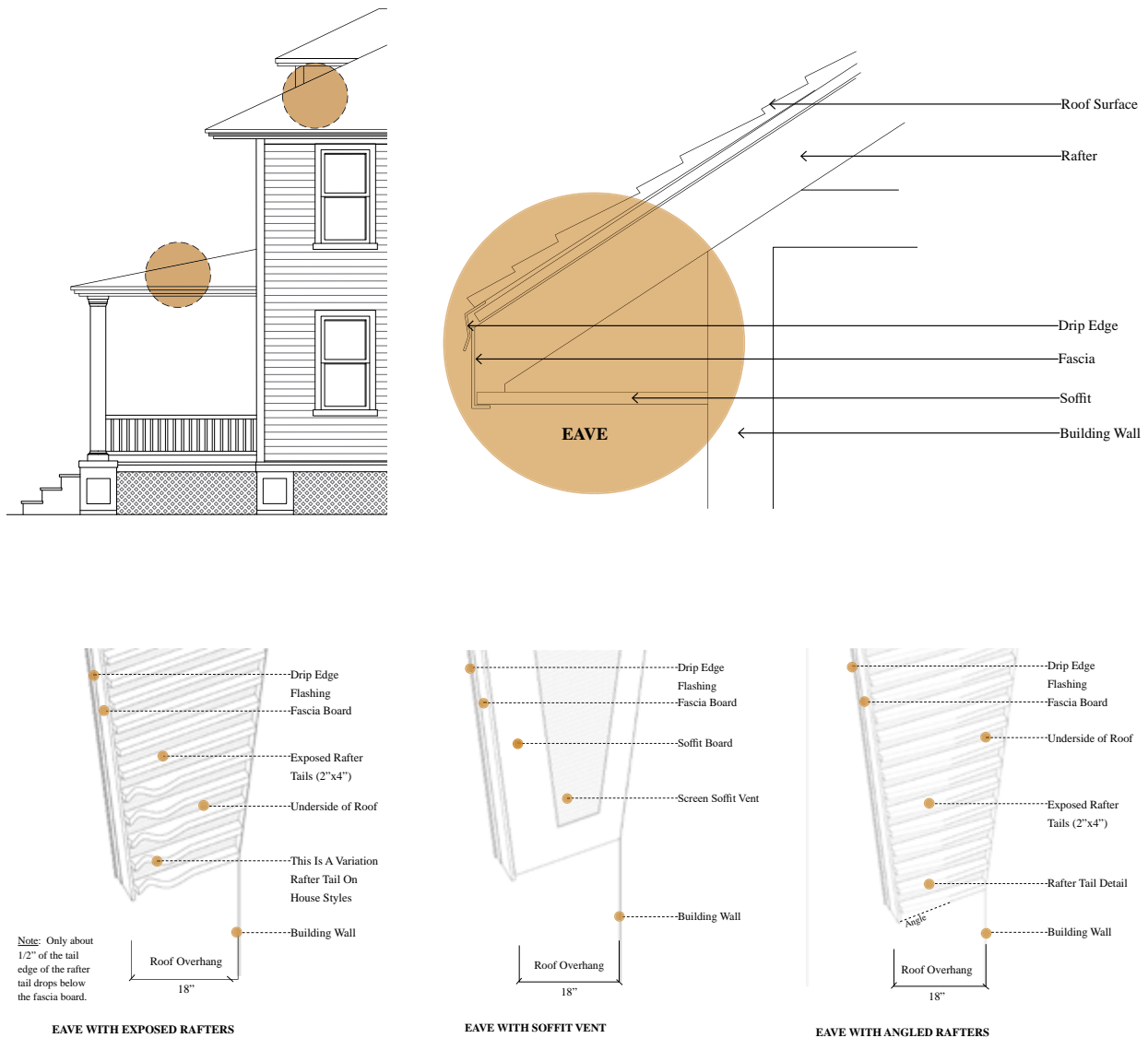

Figure 6.9: *Eaves and Overhangs*

Eaves are the lower portions of a roof that extends beyond the walls of the house. As an integral component of its design and an extension of the roof, eaves serve several practical functions. They divert rainwater away from the house and its foundation, provide locations for attic ventilation and help shade window openings.

House eaves are assemblages of smaller architectural features that range from overhangs with open and

closed soffits on most of the simple historic house styles, to those with more visible details and ornamentation on the Revivalist house styles. The various components of an eave often includes the roof's rafter tails – exposed or enclosed in the soffit; eave vents; fascia boards with metal drip flashing; rain gutters; and decorative brackets. The composition of these eave assemblages is directly related unique stylistic character of each historic house style and should be maintained as essential architectural features.

Guidelines for Preserving Eaves on Historic Houses



ACCEPTABLE

- Overhangs and eaves that are maintained as originally designed and constructed.
- Eaves that use similar materials and elements when replacing deteriorated features.
- Low profile and rounded gutters that do not cover up architectural features.



NOT ACCEPTABLE

- Addition of soffits and eave features that were not original house design.
- Soffits and fascias that cover exposed rafter tails.
- The addition of new features that would irreversibly damage or obscure original trim and other architectural features.
- Eaves returns with a “bird box” or “pork chop” closure feature.
- Large box-type gutters and/or gutters that cover up architectural features.



Recommended Best Practices for Maintaining and Preserving Eaves and Overhangs:

- Homeowners should perform regular inspections of eave assemblages and their individual components to identify signs of deterioration or water damage.
- Historic houses that are under mature tree canopies may require additional attention to ensure leaves and other organic debris does not clog gutters or hamper the diversion of rainwater away from the structure.
- Unless significant deterioration exists, original eave details should be repaired and maintained with approved materials, rather than modified or replaced.
- Because eaves have upper and underside exposure, deteriorated roof decking in these areas should be replaced with tongue-and-groove decking, not plywood. Deteriorated rafter tails should be repaired using Dutchmen-type repairs, or replaced with the same dimensional lumber that is “sistered” on to the existing rafter.
- Homeowners should refer the National Park service’s Preservation Brief #47 - Maintaining the Exterior of Small and Medium Size Historic Buildings for further guidance on eave maintenance and preservation.



6.2 PORCHES

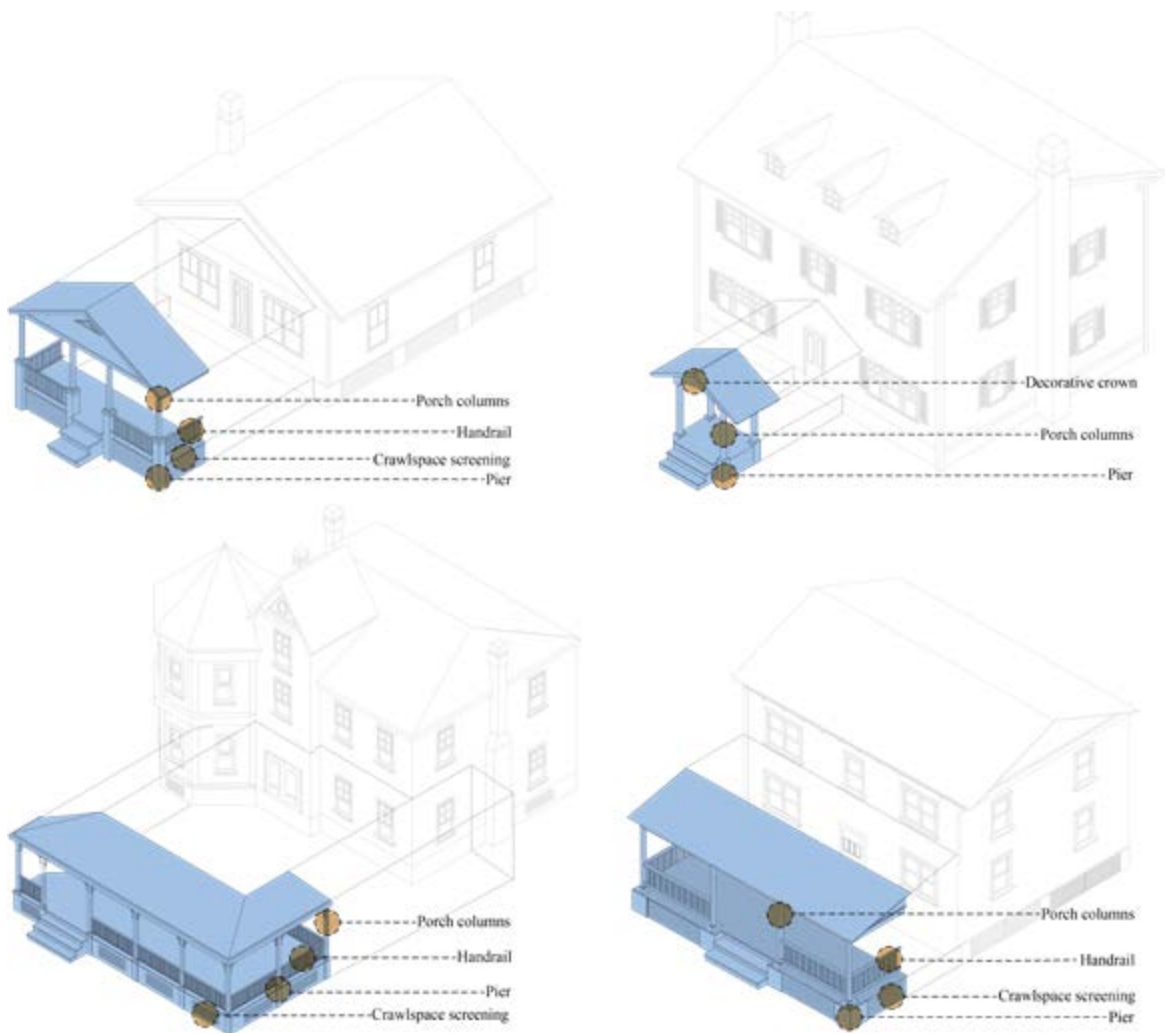

Figure 6.10: Porches of Historic House Styles

In each of the City’s historic districts, houses that were built until the mid-1930s often had a prominent front porch feature that oriented the structure towards the street. As such, porches are integral to the design and architectural styles exhibited by these structures and help to define the character of the neighborhood block face. At the scale of individual houses and the neighborhood, porches reinforce a tradition of visually embedding the house into its neighborhood context. They further distinguish historic districts as front porch communities with architectural variety, but with common features that convey a sense of tradition and familiarity.

Porches are semi-private outdoor living spaces on historic houses that were considered ideal for the Central Florida climate during Lakeland’s formative years. Most porches were designed to provide overhead protection from the intensity of direct sunlight, rain downpours and a safe transition from the outdoors to the house’s private domain. These shady spaces quickly became family gathering spaces and defined a type of lifestyle that extended opportunities for outdoor living throughout much of the year. As this trend expanded, front porches became the visual symbol of traditional residential areas and allowed residents to engage their neighbors on a more frequent basis and afforded a safe location to monitor activities along the street.

6.2.1 PORCH TYPES

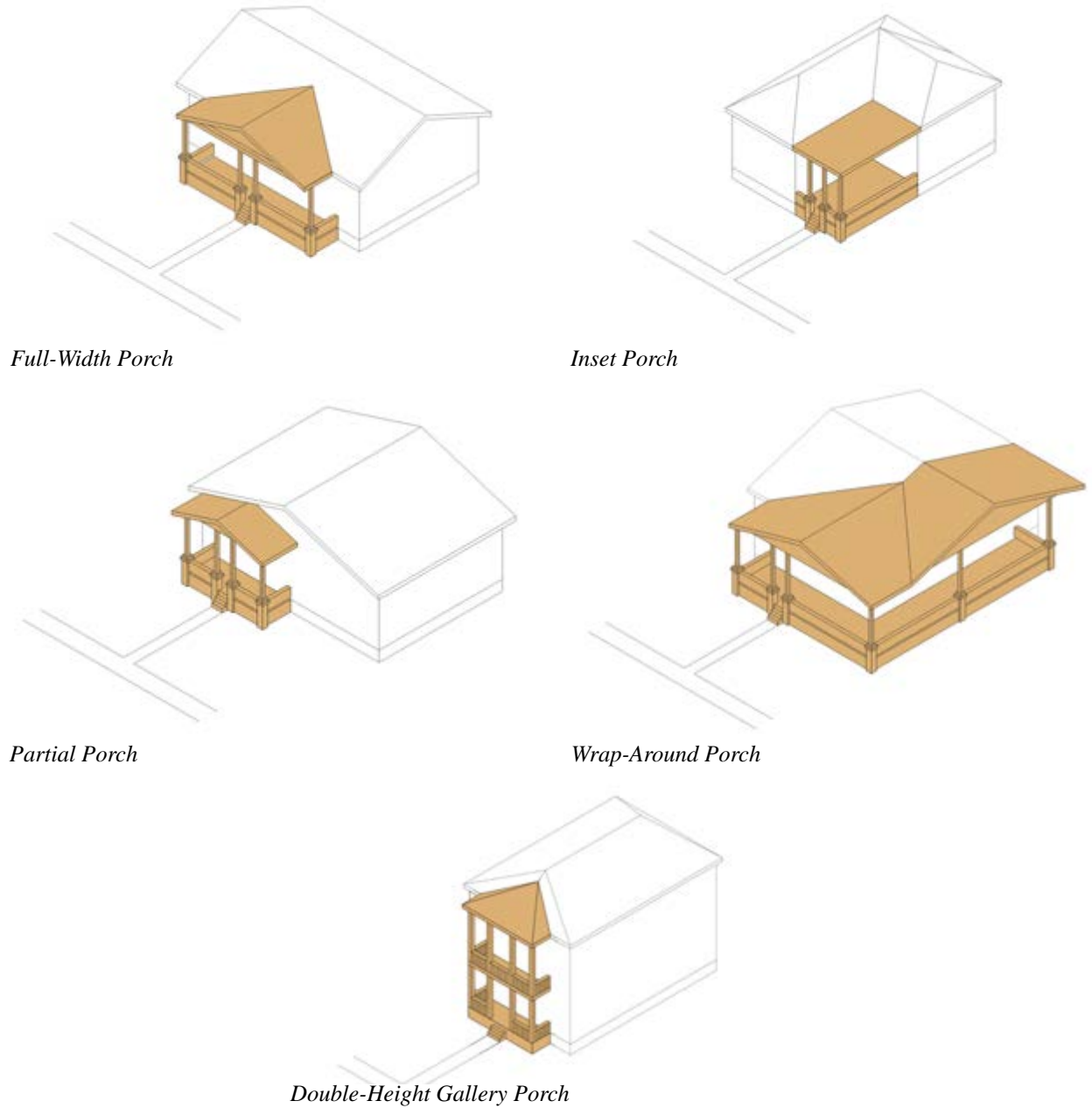

Figure 6.11: Common Porch Types on Historic Houses

As one of the most visible architectural features of a historic house, the front porch took on numerous configurations and stylistic compositions. They were integrated into a number regional and imported house styles as early “sustainability” features prior to the widespread availability of residential air conditioning after the mid-twentieth century.

Although they vary from one house style to another, front porches were flexible design features that were based on variations of five common configurations: a full façade-width porch, an inset porch, a partial porch, a porch that wrapped around two sides of the house and a multi-story porch.

6.2.2 PORCH FEATURES

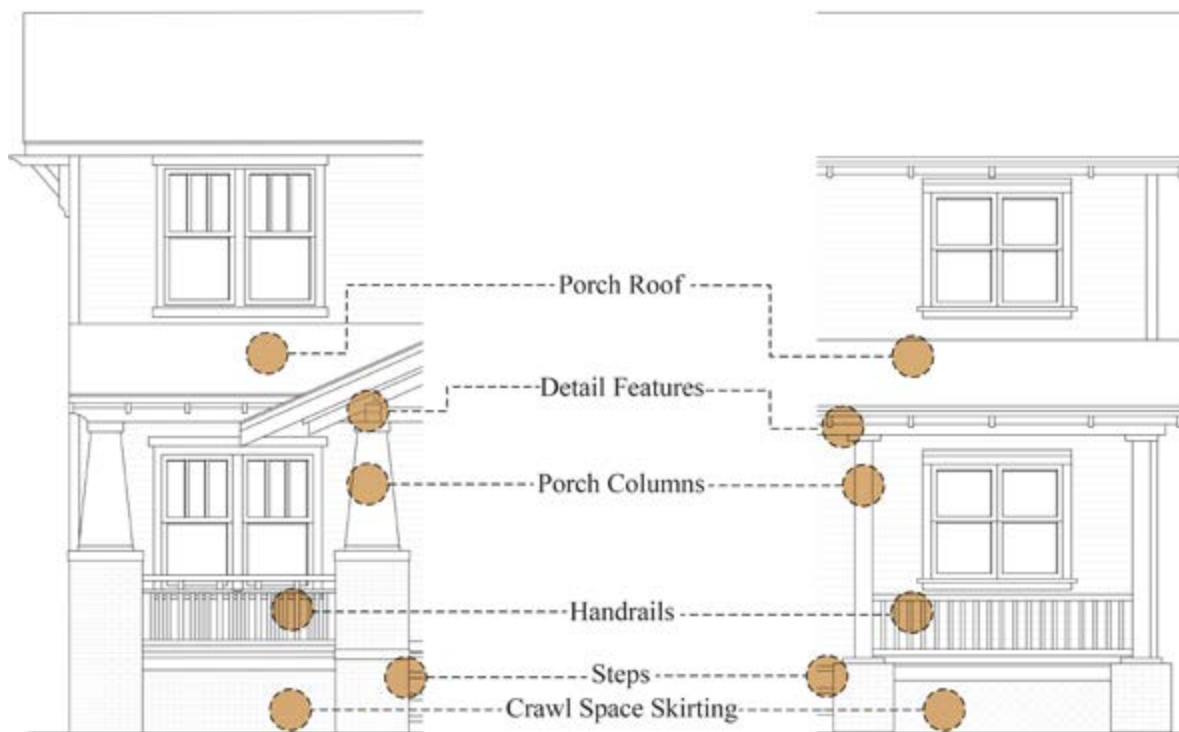

Figure 6.12: Common Porch Features on Different Historic House Styles

Front porches are assemblages of smaller architectural features and details that contribute to the general appearance of the front of historic houses, including the roof area, the space underneath, columns and other porch supports, decorative elements, the porch floor, front steps, foundation walls and crawl space skirting.

Most of the original front porch components were built of wood. During the late nineteenth and early twentieth centuries, a range of milled lumber, wood details and ornamentations were made available from distant mills – facilitated by the arrival and expansion of local railroad networks. These included components such as dimensional lumber, turned columns, ornamental scrollwork and decorative trim

features and handrails. While certain features were associated with a single house style, the availability of these materials led to some hybrid house styles that combined porch features from different houses for enhanced aesthetic appeal.

Brick and other masonry materials were also used for porch features. The best examples of these diverse materials in Lakeland are the various Bungalow house styles in the historic residential districts. Although brick was not a locally-produced material, it was used on some porch plinths, knee walls, and other porch elements to complement the house. As these structures were built in larger numbers, they incorporated more masonry, stucco and cement-based front porch materials.

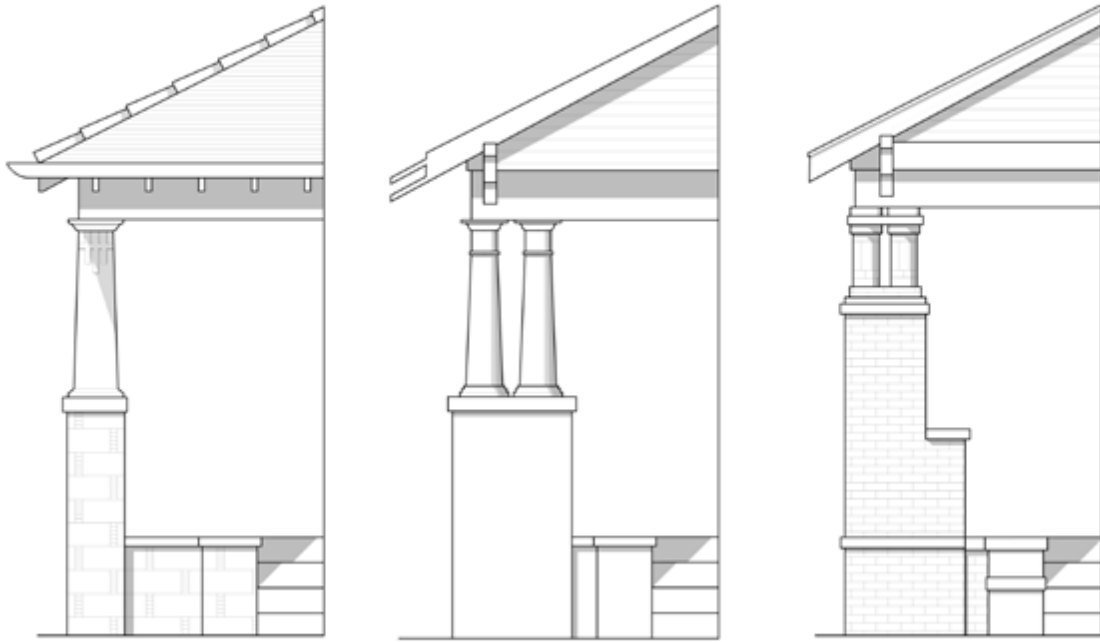

Figure 6.13: Bungalow and Craftsman Porch Column Variations



6.2.3 SCREEN PORCHES



Screening in porches are common modifications to different historic house styles in Lakeland. Screen enclosures expand the utility of porches and provide an “insect-free” outdoor living space. The idea for screening in porches emerged during the late nineteenth century just after window screens became widely available. Today, screened porches and glassed enclosed porches may be implemented by a homeowner at any time during occupancy.

When screen porches or porch enclosures are added to a historic structure, they should take into consideration the design of the host structure. These modifications should complement the front porch and façade of the structure and not detract from the visual clarity of the house style.

Guidelines for Screen Porches and Porch Enclosures



ACCEPTABLE

- Screen porches that are well-integrated with the porch proportions, configuration and original design.
- Screen porches and enclosures that complement the front porch and primary house façade.



NOT ACCEPTABLE

- Screen porches and enclosures that detract from the original character of the historic house style.
- Screen porches that use materials, features and configurations that are out of scale or detract from the visual clarity of the historic structure.



6.2.4 FOUNDATIONS AND CRAWL SPACE SCREENING

Most historic residential structures in the City are elevated approximately 18 inches to 30 inches above grade on foundation piers of brick or concrete. As a result of the elevated ground floor in these structures, the open space that occurs underneath is commonly known as a crawl space. Some houses may leave this space open, while others may use screening or skirting along the front and sides to limit access to the crawl space underneath. Although screening is not required, it is highly encouraged.

This screening usually comes in contact with the ground and regardless of material, it will likely require maintenance over time, or may need to be repaired or replaced periodically.

Compatible Modifications

Wood or vinyl lattice panels are appropriate crawl space screening materials for most historic structures. Where used, the grid of the lattice panel can be installed vertically or on a diagonal. The finish color of these screens should complement the base color of the structure and not detract from its visual character. Framed or unframed panels should fill the entire crawl space opening from the sill line to the ground and from pier to pier. Staggered or lattice brick may also be used as crawl space screening where appropriate.

Incompatible Modifications

Lattice panels should not be installed against walls or on the front of foundation piers. Concrete masonry units (CMU's), plywood, pavers, or faux stone are not allowed as screening materials for crawl spaces.

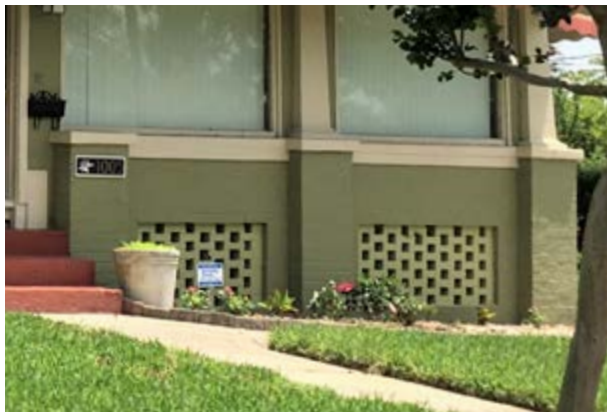

6.2.5 FRONT PORCH RESTORATION AND REHABILITATION

A very distinctive historic feature which is common among the several styles of architecture found in the Historic Districts (Bungalow, Vernacular, Colonial, Mediterranean, and Queen Anne) is the front porch. Because of the prominent part the front porch plays as an element of the exterior of the house, it is important to ensure that any alterations do not threaten the original character of the building. In addition to exhibiting distinctive features which characterizes the individual structure and its architecture, the porch also serves a number of very practical functions:

1. Provides protection from the elements for the main entrance of the house,
2. Assists in meeting social needs by providing a place to meet and greet,
3. Lends a sense of security and privacy to those within the house,
4. Exhibits distinctive architectural features which have come to identify the neighborhood, and
5. Extends the usable space of the house.

As is the case with many historically significant homes, we have seen an “evolution” of modifications occur over the years. The front porch has been no exception. Originally designed to remain open, the porch functioned as a breezy gallery or veranda with distinctive columns, railings, and decorated brackets, often with a lattice foundation enclosure. With the porches remaining open, the beauty and grace of the entry ways, with their elegant doors and side and top lights, were visible from the street. Once screens became commonplace, many porches were “screened-in” to provide protection from insects, especially mosquitoes. In most cases, “screened-in” porches were still able to retain their architectural

features – i.e. railings, columns, brackets, etc.; however, the architectural significance of doors and windows was generally hidden from direct view.

Now that we are a society accustomed to a climate-controlled environment, we are seeing porches becoming completely enclosed. This provides the home with added living-space within an air-conditioned setting. Unfortunately, without very careful attention to detail, many porches have lost their architectural and historical significance once they’ve become enclosed. Individual features of the porch become difficult to discern and the architectural patterns of the neighborhood are lost.

With these thoughts in mind, here are some suggested guidelines for front porch modifications:

1. If at all possible, retain the porch as an “open” porch, and maintain its original features. This is the preferred means of preserving the architectural and historical quality of the homes, especially in relation to its porches.
2. The second preferred means of preserving and/or rehabilitating porches is by creating a “screened-in” porch. In this case, structural components, including screen doors, should be made of wood rather than aluminum. Distinctive architectural features, such as railings, column, brackets, etc. should be retained.
3. The third option is to close in the porch by means of constructing walls, windows (fixed glass has worked well in some cases), and doors. This is the most difficult and costliest modification and requires sensitivity to the unique features of the building. It is strongly discouraged and requires approval by the Historic Preservation Board.

Some examples include:

BUNGALOW: Continue with the original window sizes and patterns. Leave roof supports and exposed rafters visible. Retain the “bulky” bungalow style porch columns or heavy piers.

VERNACULAR: Leave visible turned posts and simple balustrade, as well as the decorative brackets.

COLONIAL/NEO-CLASSICAL: Retain original width siding, windows and molding, columns, doors, side-lights and transoms.

MEDITERRANEAN REVIVAL: Use arches, decorative tile, doorways to accent any enclosure.

QUEEN ANNE: Avoid modifying projecting bays and pavilions, the variety of roof forms, decorative gables and mill work (especially those features which accentuate corners and edges). Retain the original turned posts and columns, doors, windows, etc. The Queen Anne style is probably the most difficult to enclose without compromising the integrity of its architecture.

MODERN MASONRY: The small front-entry porches should not be enclosed.



Guidelines for Preserving Porches



ACCEPTABLE

- Porch columns, railings and trim details should match the original architectural style of the house.
- Deteriorated features of the porch should be duplicated in shape and character as close to the original as possible.
- Corner boards on wooden porches should be preserved and not covered up or replaced with narrower features.
- Enclosing porches may be permissible if approved by the Historic Preservation Board. The original appearance of the porch should be retained.
- Glass enclosures or weathered-in porch modifications should allow the original porch elements to be clearly visible.



Porch Skirting in a Frame



Historically Correct Handrail Height



NOT ACCEPTABLE

- The removal, wholly or in part, of a porch, balcony, railings or steps if they exist as part of the original structure.
- Replacement of original porch features with inappropriate materials or features that conflict with the original porch design.
- Removal or covering up original porch deck or steps.



Porch Skirting Without a Frame



Handrail Height Too Tall

Recommended Best Practices for Maintaining and Preserving Front Porches:

- Homeowners should perform regular inspections of porch assemblages and features to identify signs of deterioration or water damage.
- Historic houses that are under mature tree canopies may require additional attention to ensure leaves and other organic debris does not clog gutters or hamper the diversion of rainwater away from the structure.
- All original wood porch features should be retained unless deteriorated beyond repair.
- Where replacement of porch features is required, homeowners should use wood

features (structural or decorative) similar to those being removed.

- All new structural wood porch features must use approved pressure treated, structural grade lumber.
- Homeowners should remove all growth and organic material from porch fronts that might otherwise hide cracks or trap moisture against the structure.
- Homeowners should consult Preservation Brief #45 – Preserving Wooden Porches for further guidance on the maintenance and preservation of porches on historic houses.



6.3 FRONT DOORS AND ENTRANCES



Figure 6.14: Historic Door Styles - Bungalow / Craftsman



Figure 6.15: Historic Door Styles - Mediterranean Revival / Spanish Colonial

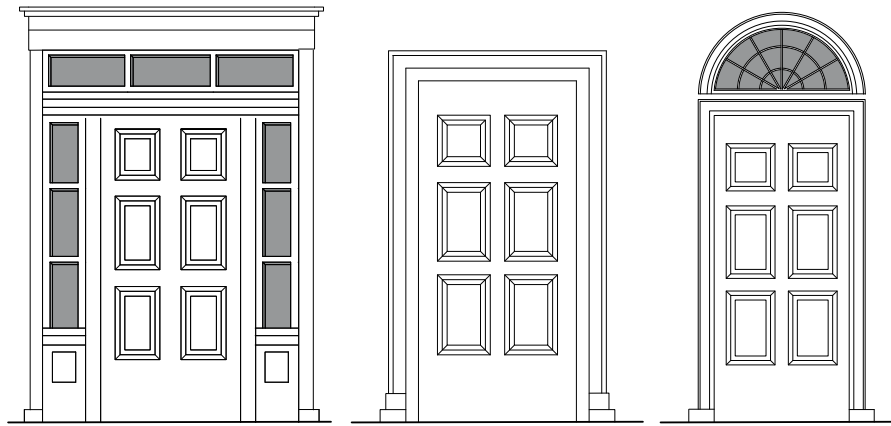

Figure 6.16: Historic Door Styles - Colonial Revival

In addition to their most practical functions, doors and entrances on many historic houses were often incorporated as expressive architectural elements. Late nineteenth and more ornate Revivalist house styles built in the City shortly afterwards included

ornamental entry doors and casework to accentuate this feature both inside and outside the house. Doors were often considered a focal point on house facades and were the most visible features to visitors.



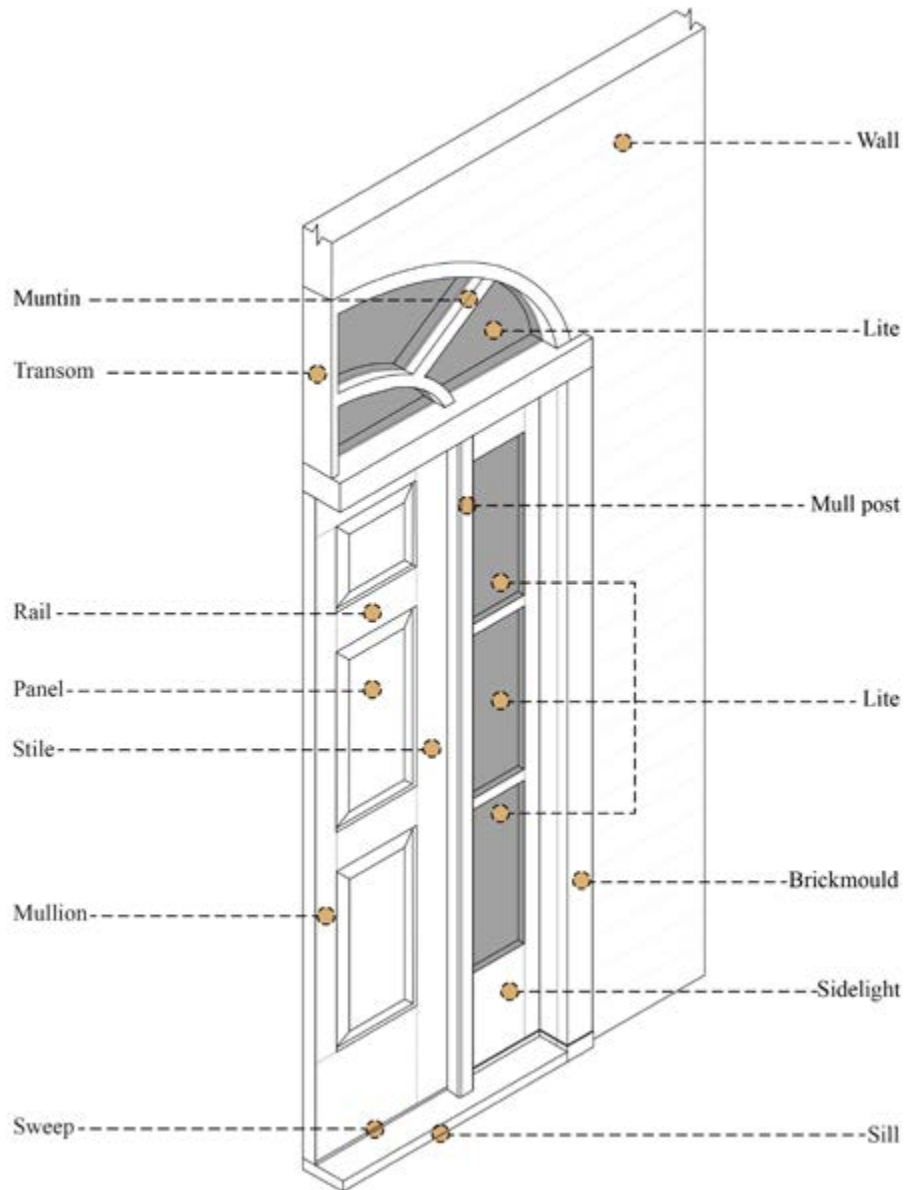

Figure 6.17: *Anatomy of a Door*

Original doors and entrances on historic houses built before the mid twentieth century were constructed of old-growth wood which made them durable and long-lasting. These early doors were built with wood planks fastened together or wood frames with panel coverings that formed a flush door surface. The addition of glass to doors as decorative feature evolved as a common practice for certain house styles. These features provided daylight in the entrance hallways and allowed homeowners to see visitors from inside. In addition to these, entry doors

in some of the larger historic houses often included decorative transom and fanlight windows above the door, stained glass elements and sidelight panels. Original doors with multiple glass openings were constructed with wood muntins that separated each pane of glass. This created relief and visual interest across the entire door panel. These more elaborate doors appeared in several house styles in the City’s historic districts and displayed a level of artistry and craftsmanship that was often visible in other parts of the house as well.

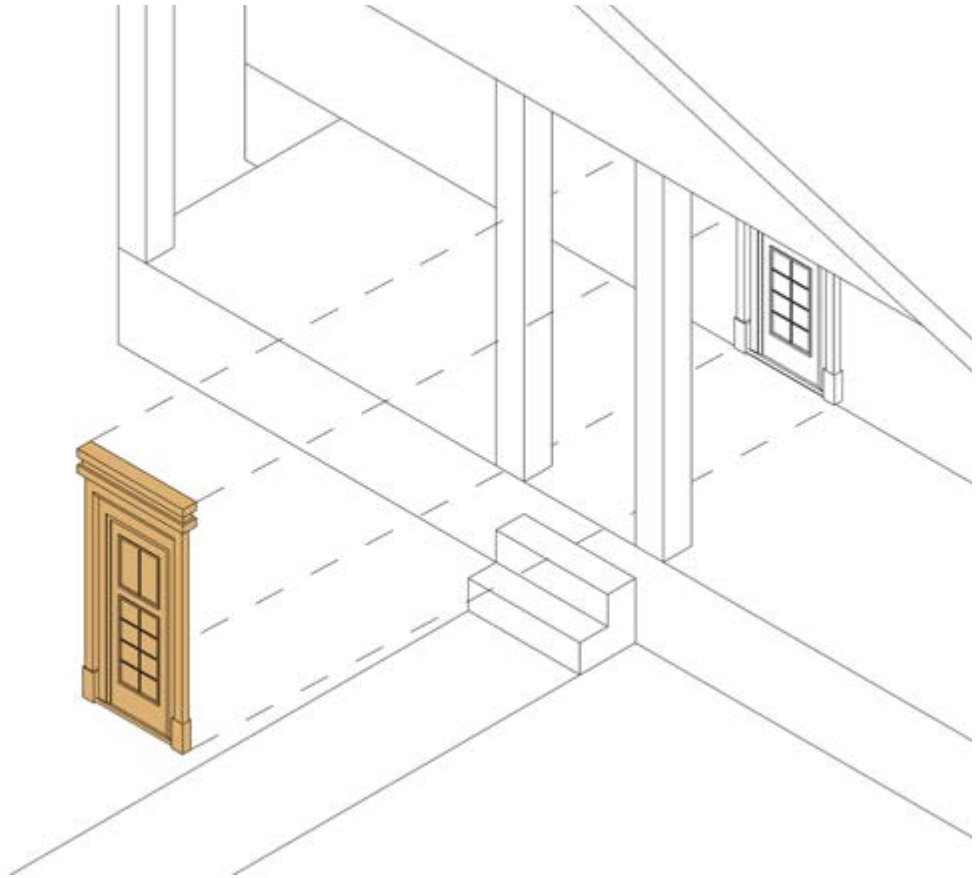
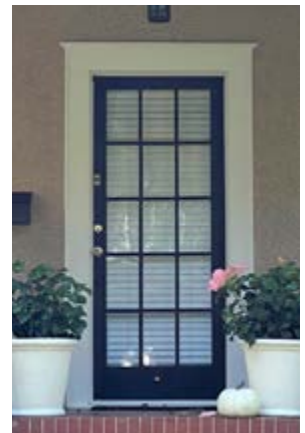

Figure 6.18: *Entry Door and Ornamental Trim*

Several houses in the City’s historic districts with elaborate entry doors also had complementary ornamental trim details at the top and sides of the door as well. As entryway assemblages, these features further distinguished the front façade of the house and enhanced the experience of transitioning from

outdoors to inside. On some historic house styles, these ornate entryways were often larger than normal and were used in conjunction with high porticos or shallow front stoops. This allowed for higher visibility of the front entrance from the sidewalk and street.



Guidelines for Preserving Front Doors and Entrances



ACCEPTABLE

- Doors and entrances that are preserved and maintained as original features that contribute to the architectural character of the structure.
- Doors and entrances that are compatible with the style of the house.
- Door openings that keep the same proportions as originally built and not enlarged to accommodate different size doors.
- Door head heights that are consistent with widow heights throughout the structure.
- Entryways and doors that retain as many of their trim features as possible.
- Replacement doors, storm doors and screen doors that are appropriate to the style of the host structure.



NOT ACCEPTABLE

- Doors and entryways that change the character of the house and are not compatible with its original style.
- Doors that do not contribute to the architectural character of the house.
- Removal, covering up or destroying original entryway and door trim or other architectural features.
- Doors and entryways that do not retain original sidelight or fanlight configuration.
- Removal of original screen doors.

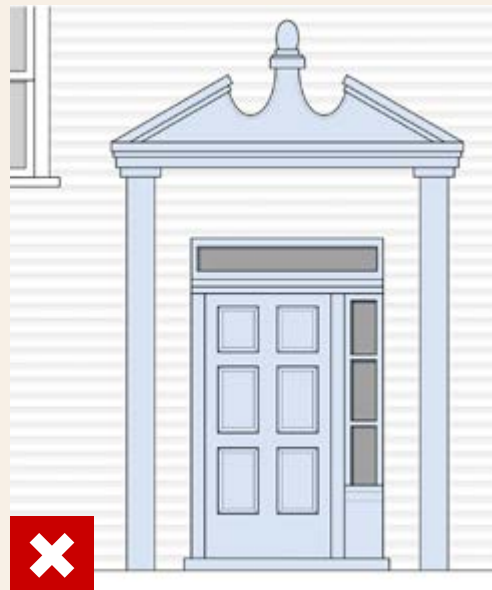

Recommended Best Practices for Maintaining and Preserving Front Doors and Entrances:

- Homeowners should perform regular inspections of front door and entrance details to identify signs of deterioration or water damage.
- Original doors on historic houses should be preserved and maintained to protect the architectural integrity of the structure.
- Door features and details should not be removed or altered unless deteriorated beyond repair.
- Where repair or replacement of original doors are necessary, homeowners should use similar wood components or use new doors that replicate the design of the original door.
- New door entrances should not be installed in historic houses where they did not previously exist.
- Original screen doors should be preserved as an integral feature of the structure's design. If storm doors are needed, they should have a full-view glass panel.
- Homeowners should refer to Preservation Brief #47 – Maintaining the Exterior of Small and Medium Size Historic Buildings for further guidance on maintaining and preserving front doors and entries on historic houses.

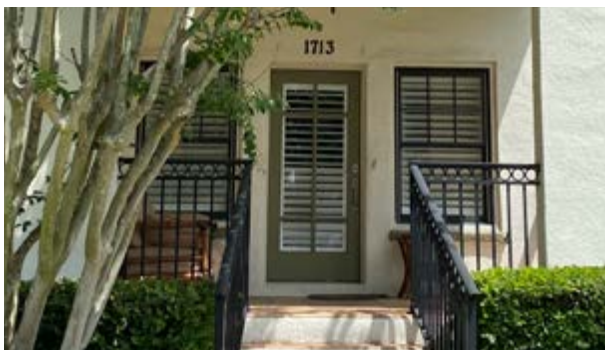

6.4 WINDOWS AND SHUTTERS

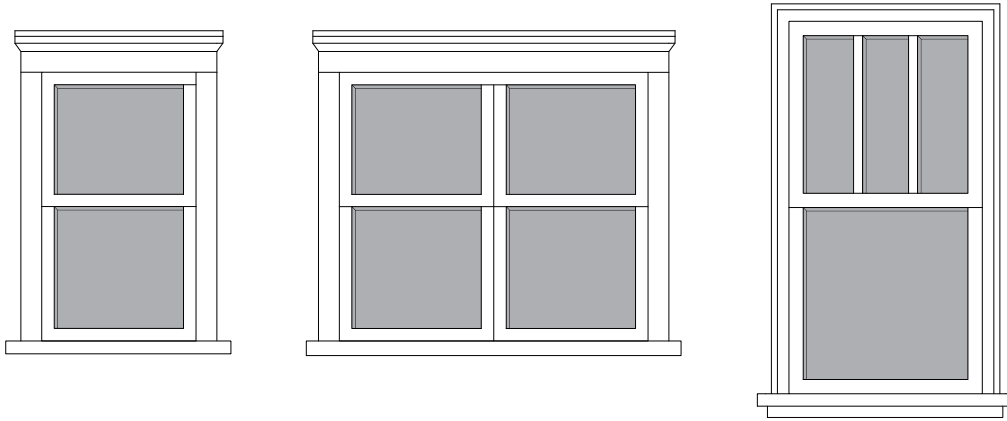

Figure 6.19: Historic Window Styles - Bungalow / Craftsman

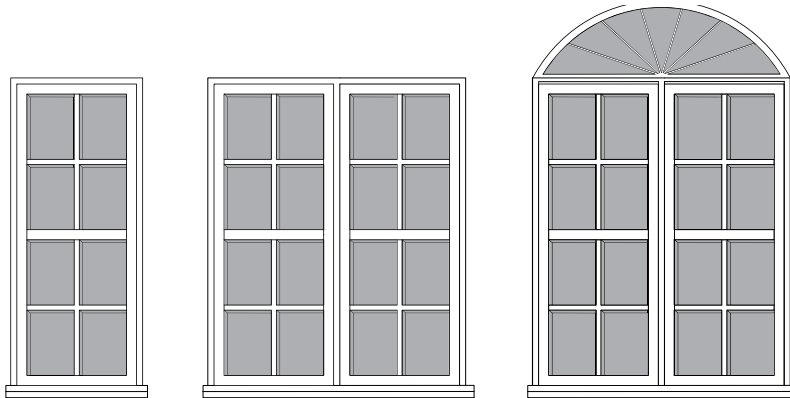

Figure 6.20: Historic Window Styles - Mediterranean Revival / Spanish Colonial



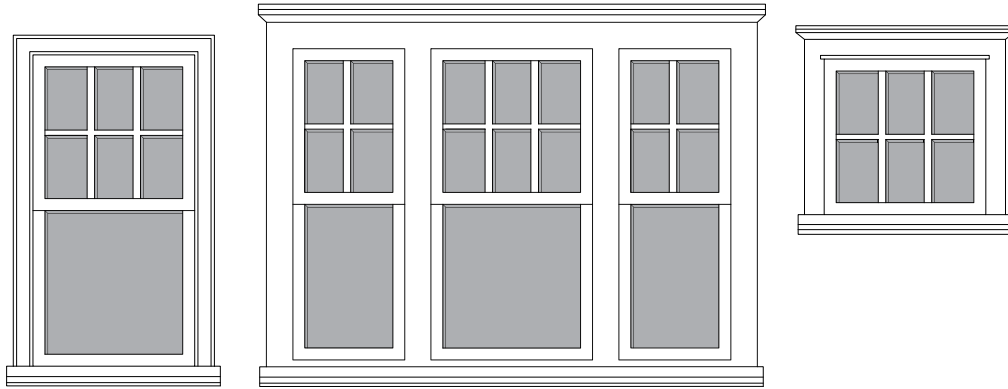

Figure 6.21: Historic Window Styles - Colonial Revival

Windows on historic houses in Lakeland are character-defining features. Along with other prominent elements and details, they reinforce the unique character of each architectural style. In addition to their primary functions for interior daylighting and outdoor visibility, windows also contributed to the interior thermal comfort of the house itself. All of the historic houses in Lakeland were constructed well before air conditioning was available and were located and sized to take advantage of natural air flow in and around the structure. This is evidenced by the widespread use of double-hung windows. These

windows often have taller, vertical proportions so that one or both window sashes could move up or down to induce cross ventilation and interior air flow.

Windows are also major contributors to the stylistic variations of historic houses. Their location in the façades of houses create a discernible rhythm and sense of order for each exterior wall plane. The patterns they exhibit by the division of glass panels and their outer trim features adds to their visual interest, as well as the character of the house.



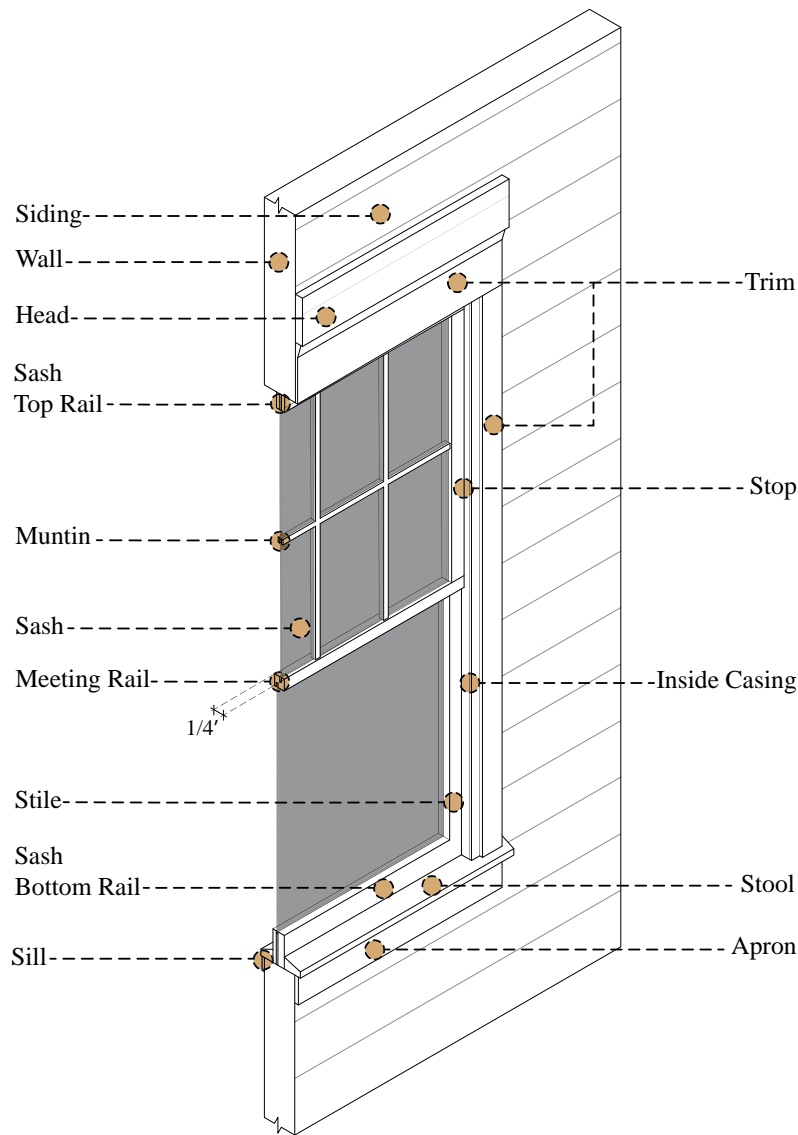

Figure 6.22: *Anatomy of a Window*

Historic wood windows were constructed of small milled wood components and small pieces of cut-glass panels. Some were made locally or on-site for the City’s oldest houses, but most arrived by train along with lumber and other pre-made house components. The arrangement of these features in the window frame is what gives each its unique identity. For some historic houses, the more decorative windows were reserved for the street-facing façade with more simplified windows for the sides and rear of the house. Larger, “high-style” historic houses were meant to be seen from different sides and used the same windows or similar variations in a more

consistent manner. In addition to the window itself, other related features are part of many historic window assemblages. These include numerous types of window trim elements that gives the window its integrated appearance in the wall of the house and in many instances, window shutters. Exterior window casings were made of a number of milled boards and moulding profiles. Original window shutters were integrated in with windows of certain house styles as a functional feature. These shutters were operable and when closed, provided protection over the glazed window sashes during inclement weather.

Guidelines for Residential Windows

For Contributing Buildings

- Preserve original windows. Original windows should be repaired and restored, rather than replaced.
- Use clear replacement glass to repair broken panes. Do not use tinted, reflective, opaque or other non-traditional glass types.
- Existing window trim, casing, and other decorative details contributing to the building's character should be preserved and retained. Any replacement of trim, casing, or other decorative details surrounding the window must use the same or similar material of the same design, profile, and dimension.
- Window openings should be kept in the same proportion as originally provided. Window head heights should be consistent throughout the building. Avoid enlarging or reducing window openings to fit air conditioning units.
- Preserve historic window shutters. Shutters should be used only when their previous existence can be documented, and the details reproduced as closely as possible. Shutters should match the height and width of the window opening and be mounted to



be operational or appear to be operational. Operational shutters should cover the entire window when closed.

- Preserve historic window screens. Use wood screen window frames matching the profile, size, and design of those historically found when the existing screens are deteriorated beyond repair. Ensure that the tint of replacement screen matches or is similar to the original screen or those used historically.
- Full-view storm windows are permitted to be installed on the interior of window openings for improved energy efficiency. Storm windows may be installed on the exterior as long as the visual impact is minimal and original architectural details are not covered.
- See the City's Historic Preservation [Website](#) for window restoration grant and assessment resources.



Guidelines for Residential Windows

For Contributing Buildings

- Replacement of original windows should only be considered in cases where original windows have **deteriorated beyond repair** (see sidebar).
- Replacement window requirements:
 - ◇ Window design should reflect the architectural style of the building (see Chapter 5: House Styles for window designs appropriate for specific architectural styles).
 - ◇ Must retain the opening size of the original window.
 - ◇ Must use the same type of window as the original. Double-hung sash windows may be replaced with a double-hung sash or single-hung sash window.
 - ◇ Must retain the same divided lite/pane pattern as the original window. Muntins/grids must be dimensional and mounted to the exterior glass, approximately of the same dimension as the original window.
 - ◇ Must be installed with a recess inside the casing of the window opening to produce a shadow line (flush installation is not permitted); box or block frame windows are recommended as fin/flange windows do not produce an adequate recess.
 - ◇ Double or grouped windows may not be separated by a standard mull bar and must be separated by a wood or similar material mullion of the same dimension as the original mullion.
 - ◇ Window must be trimmed out with wood or similar material of the same design, profile, and dimension as the original, including angled sill and top drip edge. It is recommended that the original window trim and casing be preserved.

Repairable Window:

- Glass missing or broken
- Meeting rails not aligning
- Cords broken or hardware missing
- Sill or frame rotted
- Partially rotted rails and stiles that require patching



Beyond Repair:

- Missing components or units
- Extreme wood rot
- Where 50% or more of a window's components must be reconstructed, a replacement may be considered
- Replacement sashes may also be constructed to fit within the original frame

- ◇ Non-historic windows such as jalousie, awning, and aluminum single-hung sash windows, may be replaced with windows that are typical for the architectural style of the building.
- ◇ Replacement windows differing from these requirements must be approved by the Historic Preservation Board.
- Replacement of original steel casement windows is discouraged because a compatible alternative is not generally available.

For Non-Contributing Buildings including New Construction

Windows are a very important element in establishing the architectural character of buildings. As such, seemingly small changes in window configuration can have surprisingly large and potentially adverse effects on the over-all appearance of a historic district. The windows of any non-contributing or new structure in a historic district should reflect the proportions and stylistic features of windows on surrounding historic buildings.

- Frame windows in materials, casing, and trim that appear similar in scale, proportion, and design to those used traditionally in the neighborhood. Concrete block and stucco homes should also include window and door sills.
- Use single-hung sash, double-hung sash, awning, horizontal slider, or casement windows where appropriate.
- Existing jalousie, awning, and metal and vinyl replacement windows may be replaced with windows that are typical for the architectural style of the building.
- New windows should be similar in shape and type to historical windows in the surrounding historic district. Odd window shapes, such as octagon, round, diamond, etc., should be avoided.

- Grouping pattern of windows should mimic those of adjacent historic buildings. Historic windows were often installed in pairs or groupings of three especially on the front façade.
 - If insulated glass is used, muntins should be included on the exterior with a significant depth and dimension to provide a suitable reveal.
- New and replacement windows shall be installed with a recess inside the casing of the window opening to produce a shadow line; flush installation is not permitted. Box or block frame windows are recommended as fin/flange windows do not produce an adequate recess. For large scale multi-family buildings, fin/flange windows may be used as long as the trim/ casing surrounding the window has an adequate depth, dimension, and profile to produce a shadow line.
- Shutters should match the height and width of the window opening and be mounted to be operational or appear to be operational. Operational shutters should cover the entire window when closed. Bahama shutters are permitted to be used on non-contributing and new buildings.

Guidelines for Residential Windows



ACCEPTABLE

- Repair and restore original windows rather than replacing them.
- Maintain original window trim, casing, mullions, and other window details.
- Shutters that match the opening size of the window and are historically appropriate in material and color.
- If replacement windows are necessary due to severe deterioration of the historic windows, a replacement window that matches the divided lite pattern (if applicable) and type of the original window, matches the size of the original window opening, provides an adequate recess into the wall, and has exterior muntins (if applicable) and dimensional muntins (if applicable) may be acceptable.
- Windows that relate directly to the architectural style and character of the structure.
- For new construction, windows that are oriented in a vertical manner to relate to those in historic structures, and are consistent or coordinated in size



NOT ACCEPTABLE

- Modification of windows or window openings that alters the character of the building.
- Removal of window trim, casing, and other details.
- Reducing or enlarging window size.
- Use of stock windows not compatible with the architectural style of the building.
- Replacement windows that are not the same size as the original.
- Window pane patterns that are not the same as the original.
- Mill-finished metal sash windows are not compatible with the architectural styles of the neighborhood, with the exception of Modern Masonry Vernacular.
- Mill-finished metal storm windows and screens, with the exception of Modern Masonry Vernacular.
- Purely decorative non-functioning shutters and blinds which are undersized/oversized and inoperable, except for the decorative masonry shutters typical of the Modern Masonry Vernacular buildings. The use of security bars on windows and doors, except for Mediterranean styles.
- Use of overly decorative hardware.
- Replacement of original steel casement windows is discouraged because a compatible alternative is not generally available.

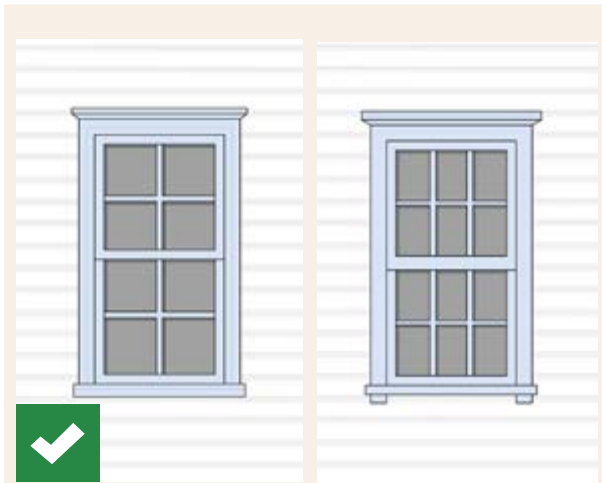

Original wood windows with six over one glazing configuration

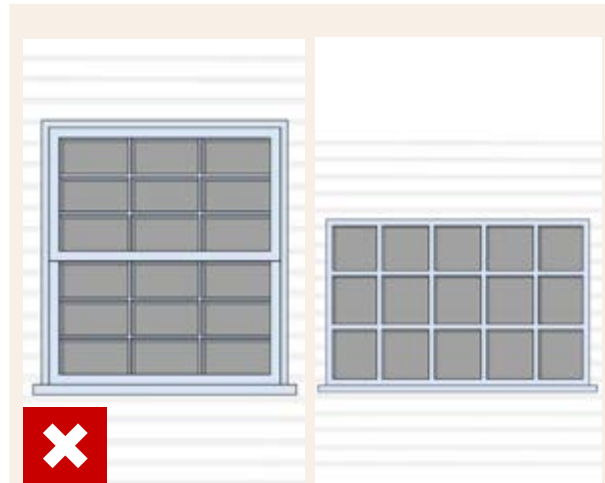

Replacement windows with four over one glazing configuration

Recommended Best Practices for Maintaining Windows in Historic Structures

- Historic structures with original wood windows should inspect all portions of these features on an annual basis to detect signs of moisture penetration and deterioration.
- Lower wood window sashes and sill areas are particularly prone to moisture damage and should be monitored for interior leaks and to ensure all glazing panes remain secure.
- Wood window casings and other trim surrounds should be inspected frequently to detect signs of deterioration and identify strategies for repair.
- As most windows in the City's historic houses

are traditional double-hung windows, they should also be inspected for operational soundness on a frequent basis.

- Homeowners should refer to the National Park Service's Preservation Brief #9: The Repair of Historic Wooden Windows for further guidance on repairing and maintaining original wooden windows; Brief #13 - The Repair and Thermal Upgrading of Historic Steel Windows; and Brief #47 - Maintaining the Exterior of Small to Medium Size Historic Buildings for further guidance on preserving and maintaining historic windows.

6.4.1 STAINED GLASS WINDOW GUIDELINES

Based on a strict interpretation of the City’s Design Review Guidelines, stained glass windows are not in keeping with the historic character of the neighborhoods. However, the City does not desire to be overly intrusive with its regulations in the Historic Districts and completely prohibit stained glass windows. At the same time, the architectural and historic character of the neighborhood should be preserved and protected. These guidelines will attempt to balance these two competing interests.

Background

Most of the homes in the South Lake Morton, East Lake Morton and Dixieland areas were built in the 1920s and 1930s. The Bungalow and Mediterranean style homes, which are (along with a few Frame Vernacular homes) the dominant architectural styles in the Lake Morton and Dixieland areas, were designed for simplicity. Unlike the Victorian home which is more ornate and cluttered, the Bungalow and Mediterranean style homes are simple in design and appearance and offer a warm, casual atmosphere. Bungalow homes were fairly inexpensive and often served as the owner’s second home. The Bungalow, Frame Vernacular and Mediterranean style homes were designed as a place to escape pressures of city life and relax. Therefore, stained glass windows were not a feature sought by a homeowner building these homes.

Stained glass windows were not popular in the United States until after World War II. In the past they were commissioned primarily for churches. Only the wealthiest of homeowners could afford stained glass windows in their homes. Victorian homes or other architecturally ornate homes were the most likely places to have them.

Many stained glass windows were as expensive as having the best artist of that day paint an individual portrait and were custom made and signed by the artist. For example, stained glass windows created by Louis Tiffany are almost priceless. Today, modern production techniques have made stained glass windows affordable to the average homeowner.

There were two great design movements in stained glass window designs during the late 19th Century and early 20th Century in the United States (1860-1930). The Romantic movement brought back bold contrasting colors and medieval, classical Gothic, and Renaissance designs in stained glass windows. This imitation of classical styles in windows was altered in the 1880s by the Art Nouveau movement in which iridescent and opalescent colors and design were a reaction against the Romantic movement. Stained glass windows became more popular in the United States after World War II when technological innovations, new building methods and a post-war housing boom allowed stained glass windows to assume greater prominence in the building of new homes. Few, if any, Modern homes in Lakeland included stained glass windows.

Recommendations

If stained glass windows are to be used in the Historic Districts and maintain compatibility with the neighborhood, the following principles should be observed when installing them:

1. The shape and size of the original window should remain the same to the greatest extent possible. Enlarging the window or changing its shape may alter the architectural integrity of the home.

2. Stained glass windows and doors have to be appropriate for the style of home in the district. Large windows on the front of the house must be examined carefully, while smaller windows on the sides and rear of homes are better candidates for stained glass.

Victorian homes are more compatible with the use of stained glass windows than Bungalow, Frame Vernacular, or Masonry Vernacular homes. Stained

glass windows with bold contrasting colors are suitable for a Victorian home while a simple elegant design for stained glass windows typical of the Art Nouveau period is more appropriate for Bungalow and Vernacular homes. It should be noted that many Bungalow homes and Tiffany stained glass windows are influenced by the Japanese in style and design. Tiffany's use of pastel colors is compatible with the Bungalow home which was designed to flow or imitate natural surroundings.

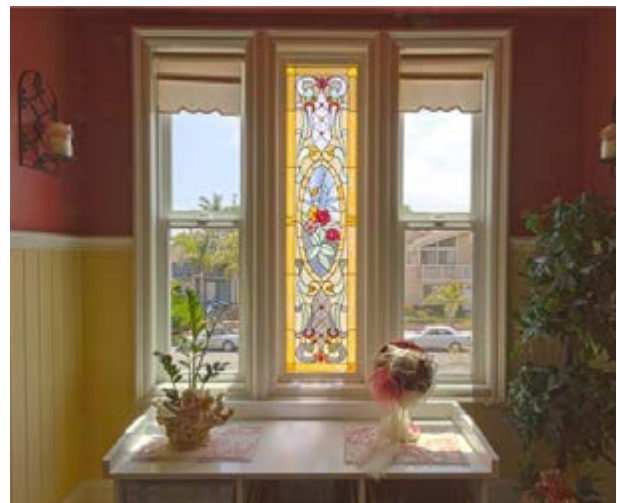

6.5 SIDING AND EXTERIOR WALL CLADDING



Horizontal Wood Siding



Stucco and Masonry Wall Finishes

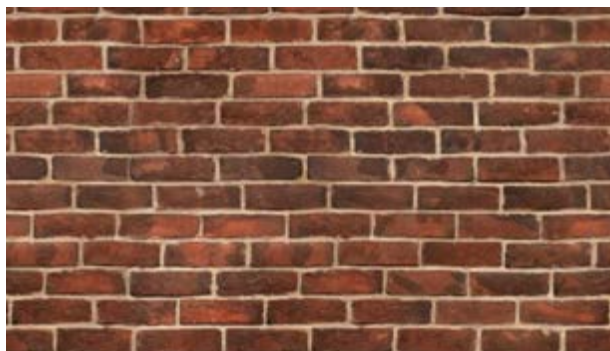

Brick Wall Surface



Fiber-Cement Lap Siding and/or Shingles

Exterior surface or cladding materials tend to vary among historic houses of the same architectural style, as well as those that are individually unique. Exterior surface materials or cladding provides outer wall protection for the house and serves an aesthetic role in helping define the architectural character of the house. These materials and features keep rain from penetrating the walls of the house and causing internal moisture problems. They also provide solid exterior surfaces that are capable of deflecting wind and wind-borne debris.

In Lakeland, historic houses typically use variations or combinations of three exterior surface or cladding materials: horizontal wood siding; painted unit masonry or cement-based stucco; or brick. Wood board siding was the most popular cladding material for houses in Central Florida during the late nineteenth and early twentieth centuries. It was plentiful, easy to install and was relatively durable when properly

primed and painted. Masonry and cement-based exterior finishes became more readily available during the early twentieth century, it began to supplant the popularity of wood as a more economical alternative. Although brick was not a local material during this time, it was used sparingly on some houses for accent purposes, or for entire walls on some larger, more expensive Revivalist-style houses. Other houses were initially built with asbestos shingles, a product that has since been discontinued due to its potentially harmful health effects. While each of these materials have different durability and aesthetic qualities, they all need to be maintained and likely require repair or replacement over time. To maintain the integrity of the outer shell of historic houses and preserve their architectural character, it is essential that these materials be cared for in a manner that is sensitive to the way the structure was originally built.

Guidelines for Preserving Exterior Siding and Original Wall Cladding

Wood Siding

- Exterior siding should be similar in style to the original.
- If siding is replaced, all trim board dimensions and joinery details should be maintained and kept visible.
- Use the same species of wood where possible.
- One alternative for wood is Fiber cement, a mixture of Portland cement, cellulose or wood fiber material, sand, and other components. It can be formed into a variety of siding patterns, have a smooth or embossed face, or be textured for a cedar look. A special curing process leaves the final product with a low-moisture content, making it resistant to warping and conducive to paint application. These products may be used as a replacement material or for new construction.

Asbestos Siding (See Appendix 8.5.1)

- Preserve in good condition, not only for preservation purposes but mainly to avoid health hazards.
- If replacement is unavoidable, use similar board dimensions and joinery details.
- Fiber cement products may serve as replacement material.
- Federal and State mandates need to be strictly followed.

Masonry

- Retain original masonry and mortar where possible.
- Repair or replace deteriorated material with new material that duplicates the old as nearly as possible. Mortar color and texture should match that of the original whenever possible.
- Original detail should be continued and replicated. Coursing spacing and mortar joint size should be maintained.
- Avoid sandblasting or strong chemicals that have an adverse effect on masonry materials. Clean masonry only when necessary to halt deterioration, always using the most gentle method possible.
- Do not paint natural or unpainted brick or stone.

Stucco

- Keep surfaces uniform, whether smooth or rough cast.
- Repair or replace deteriorated material with new material that duplicates the old as nearly as possible. Color and texture should match that of the original whenever possible.



ACCEPTABLE

- Cement board siding similar in scale, proportion, texture and finish to wood as an alternative replacement exterior cladding.
- Stucco siding for Mediterranean Revival and Spanish influenced Bungalow homes not Craftsman Bungalows.



NOT ACCEPTABLE

- Removal of original exterior cladding that is not deteriorated beyond repair.
- Replacement cladding materials that are not compatible with the style or design of the structure.
- Vinyl or aluminum siding as replacement exterior cladding.

Recommended Best Practices for Maintaining and Preserving Siding and Exterior Wall Cladding:

- Homeowners should perform regular inspections of exterior wall cladding and finishes to identify signs of water infiltration, staining, deterioration or mildew.
- Original materials such as board siding and brick should be repaired, not removed or covered up.
- Homeowners should not paint original brick or masonry that was not previously painted.
- Homeowners should use caution when pressure washing exterior wall surfaces, especially original wood and brick siding, to minimize damage to these materials.

- New cladding materials that were not original or are inappropriate to its initial design should not be applied to wall surfaces of historic houses.
- Homeowners should refer to Preservation Brief # 2 – Repointing Mortar Joints in Historic Masonry Buildings, Preservation Brief # 22 – The Preservation of and Repair of Historic Stucco and Preservation Brief # 47 – Maintaining the Exterior of Small and Medium Size Historic Buildings; Preservation Brief # 1 – Cleaning and Water Repellent Treatments for maintaining and preserving the siding on historic buildings.

6.6 AWNINGS AND CANOPIES



Wood Entry Door Canopy



Fabric Window Awning



Fabric Window and Porch Enclosure Awning



Metal Entry Door Awning



Fabric Porch Awning



Metal Porch Awning

Awnings and canopies on historic houses were original to the structure or added later by homeowners. Their primary purpose is to provide shade and overhead protection for door and window openings. They are also used to reduce heat gain in adjacent interior spaces and diminish glare from direct sunlight. These features are typically made of wood,

fabric covered metal frames or a lightweight metal such as aluminum. In the Central Florida Region, awnings were popular additions to early houses, especially on their south and west facades. These two wall surfaces are subject to intense direct sunlight during the spring and summer months.

Guidelines for Awnings and Canopies



ACCEPTABLE

- Retention and preservation of awnings or canopies that are original to a host structure.
- Awnings and canopies that are configured to be compatible with the host structure.
- Awnings and canopies that complement the architectural character of the host structure.
- Awnings that are constructed of a fabric covered metal frame or canopies constructed of a solid material affixed to an exterior wall over a window or door.
- Awnings that are sized appropriately to provide shade or shelter to window or door opening.
- Awning colors that are neutral or those that provide an acceptable visual contrast to the colors on the host structure.



NOT ACCEPTABLE

- Metal awnings or “Bahama” shutters.
- Awnings that are wider than the typical installation area over a window or door.
- Awnings or canopy colors that are aesthetically inappropriate for the host structure.
- Awning installations over windows with original shutters.
- Awnings that obscure architecturally significant details or features.
- Awnings, canopies, shutters, screens, blinds or grills that are historically inappropriate for the style of the host structure.

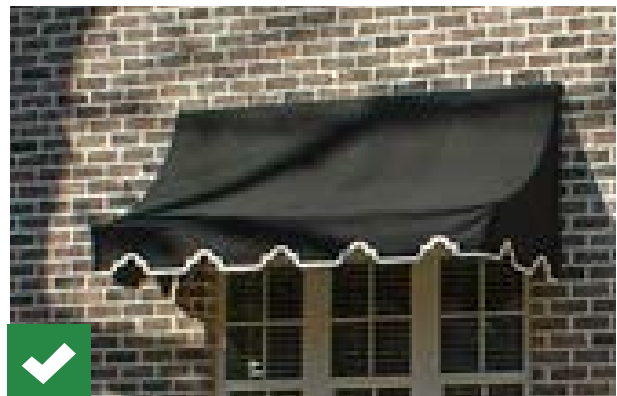

Recommended Best Practices for The Use of Awnings and Canopies on Historic Houses:

- Awning and canopy additions to historic houses should be appropriately scaled and compatible with the style and character of the host structure.
- Where awnings and canopies are added to street-facing facades, they should be installed over all window openings to reflect the house's original window patterns.

- Homeowners should refer to Preservation Brief # 44 – The Use of Awnings on Historic Buildings: Repair, Replacement and New Design for further guidance on adding awnings to historic houses.



6.7 HOUSE NUMBERS AND HISTORICAL MARKERS



Plaque with Street Numbers



Individual House Numbers



National Register Plaque



Year of Construction Plaque

House numbers on historic houses are intended to identify a street address in prominent and easily recognized manner for visitors, letter carriers and public safety personnel. They can be located in a number of places on the facades of historic houses to serve this primary purpose, while others are located to serve a more decorative purpose. These features are typically made of different weather-resistant materials, including metal, wood, tile or some other composite material. House numbers can use a variety of different typefaces, but should be at least four inches in height so they are visible from the street. House numbers are often incorporated on historical markers and plaques are available in different typefaces to reflect the style of the house. Historic plaques are often used to announce the historic

status of the structure and the homeowners' commitment to preserve the historic integrity of the property. Individual structures that are listed on the National Register of Historic Places can utilize official bronze or aluminum plaques with different typefaces and stylistic variations to acknowledge this designation. The marker should not obscure significant architectural features of the home.

Historical markers should be attached carefully to prevent damage to historic fabric; fittings should penetrate mortar joints rather than brick or stone. Holes drilled should be reversible, such as by filling with wood putty or mortar, if the marker is ever removed.

Guidelines for House Numbers and Historical Markers



ACCEPTABLE

- House numbers and plaques that are affixed to a porch pier, column or beam.
- House numbers that complement the style of the host structure.
- Historical markers affixed to a historic structure that are no larger than 12 inches x 18 inches and free-standing historical markers in front yards that are no larger than 12 inches x 18 inches.
- Markers that use fittings that are drilled into mortar. All fittings should be reversible if the marker is ever removed.



NOT ACCEPTABLE

- House numbers and plaques that are larger than 4 feet tall.
- Multiple historical house markers on a single structure.
- Markers that use fittings drilled into brick or stone.

Recommended Best Practices for Incorporating House Numbers and Markers on Historic Houses:

- Property owners should add address numbers and historical plaques that are appropriately scaled and compatible with the host structure.
- House numbers and historical markers should be placed in conspicuous locations such as porch piers or next to front entry doors to allow for visibility from the street.

- Numbers/plaques should not obscure significant architectural features of the home.
- Numbers/plaques should be attached carefully to prevent damage to historic fabric; fittings should penetrate mortar joints rather than brick or stone. Holes drilled should be reversible, such as by filling with wood putty or mortar, if the marker is ever removed.



6.8 ACCESSIBILITY RAMPS

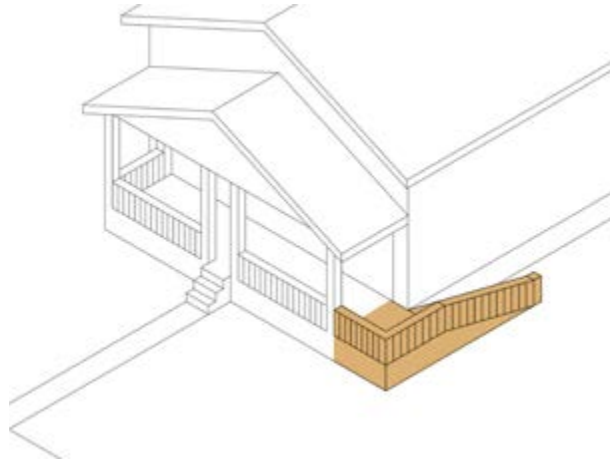

Figure 6.23: Accessibility Ramp Next to Driveway

As many homeowners of historic properties desire to remain in their homes as they age in place, accessibility ramps are becoming a common feature. These ramps are considered “universal design” features to accommodate residents that use wheelchairs to access the main level of their homes. Accessibility ramps are adapted to historic houses to facilitate access from the ground up to the porch and front entry. As additive features, permanent accessibility ramps should be integrated into the host structure in a manner that is sensitive to or compatible with its original

design. Temporary ramps should be situated so they can be easily removed when no longer needed.

Ramps should be located preferably next to a driveway on the side of the house to take advantage of the length needed for the ramp to meet the entry level of the house. These locations often provide the shortest accessible route to the main house entry on residential parcels.



Guidelines for Adding Accessibility Ramps to Historic Houses:



ACCEPTABLE

- Accessibility ramps that meet all local code requirements.
- Permanent accessibility ramps that are integrated into the design of the host structure.
- Temporary accessibility ramps on the front of a historic structure.



NOT ACCEPTABLE

- Pre-manufactured accessibility ramps that are incompatible with the host structure or detract from the visual character of the front of the host structure.
- Accessibility ramps that alter or destroy significant architectural features or details.

Recommended Best Practices for Adding Accessibility Ramps to Historic Houses:

- Accessibility ramps should be configured and located so they do not detract from the historic character of the host structure.
- Residential accessibility ramps should have a maximum incline of 2:12, or 2 feet of ramp length for every 1 foot of height from the ground to a porch or entry level.

- Permanent accessibility ramps should incorporate handrails along their entire length and tie into existing porch handrails where they exist.
- Homeowners should refer to Preservation Brief #32 Making Historic Properties Accessible for further guidance on installing accessibility ramps.



6.9 PAINT



Figure 6.24: Appropriate Paint Colors for Historic Houses

The selection of paint colors for a historic house is a decision made by its successive homeowners over time. Colors that may be visually appealing to some, may not be appealing to adjacent property owners. However, there are paint colors that enhance the appeal of certain architectural styles, while others may detract from their character.

When the City of Lakeland was founded in the late nineteenth century, exterior house paint colors were predominantly earth tones. White was also used for the body of houses and later for their trim and ornamental features. After the turn of twentieth century, new colors were being introduced to provide greater choices. This would coincide with the rapid expansion of residential development throughout much of Florida during this time.

For historic houses, the key to successful paint schemes is choosing a complementary color combination using three colors representing body color,

trim color, and an accent color. Depending on the architectural style of the house, typically no more than four colors should be used. While some homeowners may be inclined to paint a historic house all white, this may diminish its visual character by obscuring many of its original architectural details. Depending on the style of the house, paint colors should be chosen that are historically accurate, or include combinations that enhance the visual appeal of the structure and its carpentry details.

Regular painting will help protect the exterior of a house and its decorative features from the effects of weather over time. The proper use of primers, sealants and water repellants will also contribute to the life of exterior cladding materials. However, each time a house is painted, clean wall surfaces, removal of loose or cracked paint and other preparation are necessary for good paint adhesion and a longer-lasting coat of paint.



6.9.1 EXTERIOR PAINT COLORS

Choosing an exterior color can be one of the most significant steps you take as you maintain your house in the Historic Districts. The charm, architectural style and compatibility of your property with its environment can all be enhanced by the proper selection of exterior colors. From an historical standpoint, some areas of our country have exhibited predominant colors, especially in the northeast during the turn of the century. Today we sometimes refer to these as “colonial colors,” which include deep hues found in the dark browns, blues, reds and greens.

In Lakeland, however, no predominant colors were ever established. Because it was a “working-town,” trends and styles were not the basis for color selection. Rather, personal preference and harmony with the neighbors seemed to be the rule. To add comfort to the semi-tropical climate of the south, softer subdued colors were preferred to the dark colors of the north. For example, the Bungalow style architecture which is the most common in the South Lake Morton, East Lake Morton and Dixieland Historic Districts, was originally found in the most northern states, painted or stained dark brown or green. Initially it seemed almost imperative that earth-tones be used when painting a Bungalow. Soon after, as the Bungalow style moved south, colors quickly changed to reflect a desire for lighter shades and individual tastes. These included pastels such as beige, gray, yellow, rose, lighter greens and some blues which were popular in the 1920s. Trim and accent colors included white, cream, ivory and green.

Historically, white was a post-1910 color and may not have been as prominent in the Historic Districts as it is today. There may be several reasons for this, although we don’t know for sure. One theory is that as colors were harder to come by during the depression and the war years (W.W.I, W.W.II), white became the mainstay. Also, possibly the fact that it is easiest to paint a building all white, prompted widespread use of this color as well.

Below are some simple guidelines to help you choose exterior colors for the Historic Districts:

1. Select colors which harmonize with neighboring structures and surroundings.
2. Choose a primary or body color which will complement the color of your roof. Then coordinate accent and trim colors with your primary color.
3. Use muted colors (which include all colors but in a softer or subdued intensity) to give your house a more elegant, traditional look.
4. Using light colors including the pastels (white, yellow, light blue, light green, tans and gray), which are characteristic of the south, will make your house look larger.
5. Use of trim colors will add individuality to your home, while accent colors may be used to define architectural features of the building.
6. Suggested colors: Primary Colors Trim and Accent Colors, Pastels (including lighter shades White of blue and green) Cream, Beige/Tan, Ivory, Rose Green, Gray, Yellow, White.



Recommended Best Practices for Selecting Paint Colors for Historic Houses:

- Homeowners should use one of two recommended options for selecting paint colors: 1) Use original paint colors and 2) Use paint color combinations that are appropriate for the architectural style.
- Further guidance for paint selections can be found on the websites of several paint manufacturers including Sherwin Williams, Benjamin Moore, and PPG. Many also feature online tools to help select colors or color combinations.



6.10 MECHANICAL SYSTEMS, UTILITIES AND APPURTENANCES

Modern mechanical systems, such as central air conditioning and heat, are inevitable additions to historic houses and commercial structures. Other modern utilities and features such as air conditioning condenser units, roof-mounted satellite dishes and solar panels are also common additions to historic buildings. The visibility of these features should be minimally visible from the primary public rights-of-way.

Prior to installation of these features, their location, size and visual prominence should be carefully considered so they do not adversely impact the architectural integrity of the structure. Improper location of these features could diminish the character of a historic structure, as well as the overall character of a street or block. See also Appendix 8.4 Sustainability and Energy Retrofits.

Guidelines for Mechanical Systems, Utilities and Appurtenances



ACCEPTABLE

- Modern mechanical system and utility features that are located to the rear or side yard of the principal structure to minimize visibility from the street.
- Mechanical system features that are installed on the ground adjacent to the house concealed with fences, hedges or screen panels.



NOT ACCEPTABLE

- Residential mechanical systems and utility features that are visible from the street.
- Commercial buildings with rooftop mechanical systems that are visible from the street.
- Window-mounted air conditioners that are installed on principal façade or visible from the street.



6.11 HURRICANE PROTECTION

Historic properties are subject to the effects of hurricanes that may impact the Central Florida peninsula routinely. The major impacts that hurricanes have on historic properties are severe winds that can blow off portions of a building, send air-borne projectiles into it, or cause structural damage; and heavy, wind-driven rain that can enter a building through openings and cause interior damage, limit the use of the structure or result in major, costly repairs.

To reduce potential property damage from hurricanes, owners of historic structures, should develop a plan to fortify their properties. In addition to planning for life safety, property owners should: take steps to strengthen the underside of roofs (especially gable roofs); use removable panels to cover door and window openings; brace garage doors from the inside; and document the historic status of the structure before an impending storm through photographic and/or video media.

Recommended Best Practices for Preparing Historic Structures prior to an impending hurricane

- Property owners should undertake measures to strengthen the underside (e.g. trusses and rafters) of their roofs where possible.
- Window and door opening should use solid removable coverings that will keep wind, rain and air-borne debris out of the structure.
- Garage doors should be strengthened

from the inside.

- In addition to these basic measures, property owners should rely on local and State standards and guidelines for further guidance on hurricane preparedness.

Note: These recommended best practices for maintaining and preserving historic house features are not intended to provide comprehensive technical advice or instructions on solving historic preservation issues. This

information is meant to provide a basic understanding of historic preservation practices that are allowed under the City of Lakeland's Historic Preservation Ordinance.

6.12 RELOCATION AND DEMOLITION

The Historic Preservation Board (“HPB”) and its Design Review Committee (“DRC”) use the following additional guidance when considering the relocation or demolition of a local landmark building or building within a historic district. Relocation and demolition are generally discouraged, as the loss of historic fabric is irreversible and may diminish the character of historic districts over time. The following guidance is used by the HPB to determine whether relocating or demolishing a historic building is appropriate, and is based upon both the Secretary’s Standards for the Treatment of Historic Properties and Sub-Section 11.6.3 of the City of Lakeland Land Development Code.

Relocation Considerations

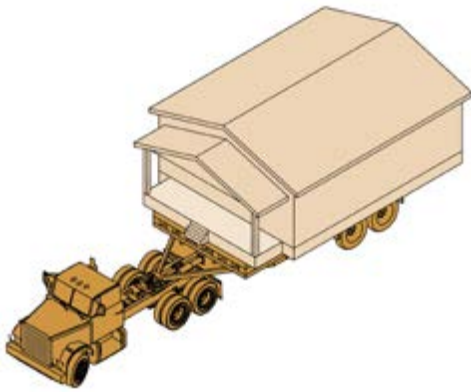

Figure 6.25: Relocation

Moving a historic building is sometimes the only way to save it from demolition, but relocation should only be used as a last resort option after all alternatives have been found infeasible.

1. The historic character and aesthetic interest the building contributes to its present setting should be considered. What is the contribution of the building to its immediate setting? How does the building impact the character of the block? **It is inappropriate to move a building that has significant impact on the setting and character of the block and area within which it is currently located.**
2. Plans for the property to be vacated and the effect of those plans on the surrounding area should be considered. Will the property be re-used for a new building? Will the new building be compatible with the character of the historic district and surrounding buildings? **It is inappropriate to relocate a historic building without plans for new construction on the subject property. New construction must be compatible with the historic character of the surrounding area.**
3. The process and feasibility of physically moving the building should be considered. How will the building be moved? Will the building be damaged during the process? Will historic materials, including foundations, porches, or additions, be lost in the process? **It is inappropriate to move a historic building if significant historic features will be damaged or lost. Damage to the historic building and loss of historic fabric should be minimized. All features should be moved, as much as physically possible.**
4. The location of the proposed relocation site should be considered. Will the proposed relocation site be comparable to the historic site? Will the new site be compatible with the architectural and historic character of the building? **It is inappropriate to relocate a building to an incompatible site. For example, a historic commercial building should not be relocated to a residential lot. The proposed relocation site should be similar to the historic site in age, architecture, setting, and location.**

Demolition Considerations

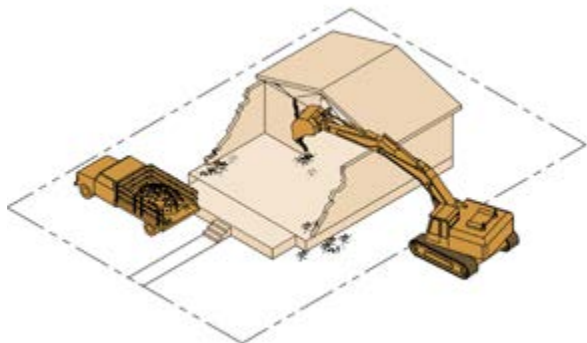

Figure 6.26: Demolition

The Historic Preservation Board discourages the demolition of sound historic buildings. A request for demolition will be determined based on the following considerations and guidance.

1. The architectural significance of the building or structure shall be considered, including a building's historical or cultural associations to its neighborhood, historic district, or to the history of Lakeland. Architectural significance is based upon documentation of the property's architectural integrity and historical or cultural significance. **It is inappropriate to demolish a building that is architecturally significant.** Further considerations include:
 - a. Does the building represent a documented architectural type or style?
 - b. Is the building a rare resource? Is it one of few remaining examples of its period of construction, or of its architectural style or type remaining?
 - c. Consider the difficulty or impossibility of reproducing the building. Does the building exhibit characteristics of historic craftsmanship, such as carved wood or detailed masonry, that would be difficult or impossible to replicate? Does the building contain historic materials, such as historic brick, stone, or old-growth lumber, that are no longer available and impossible to reproduce?
2. The contribution of the building or structure to the history or origins of the neighborhood, historic district, or history of Lakeland shall be considered. Does the building contribute to the setting and character of the district? Would the historic setting and character of the district be diminished by the loss of the building? **It is inappropriate to demolish a building that contributes to the historic setting and character of the district.**
3. The future utilization of the site, including any replacement buildings or structures, shall be considered. Will the property be reused after demolition? Will any new structure be compatible with the historic context of the neighborhood or historic district and in harmony with the massing, scale, and proportion of adjacent buildings? How will future plans affect the character of the surrounding historic district? **It is inappropriate to demolish a historic building without definitive plans for the property's reuse. It is inappropriate to demolish a building for new construction that would diminish the character of the historic district. It is generally inappropriate to demolish a building for reuse as a parking lot, as this could have an extremely negative effect on the character of a residential historic district or urban block.**

7



PROJECT PLANNING



7.1 PROJECT PLANNING

This section is intended to assist owners of historic buildings with: understanding the various conditions and features of the property that require frequent inspection; useful steps in planning a project to repair, restore or modify a historic structure; and the forms that should be submitted to the City depending on the extent and type of work being initiated.

The Inspection Checklist will help historic property owners conduct an initial assessment of the condition of different house features that are likely to deteriorate more quickly and need attention on a more frequent basis. These are mostly maintenance issues that every historic property owner should pay attention to on a routine basis. The Inspection Checklist is a tool for identifying these conditions within the structure before they lead to diminished historic integrity or costly repairs. This checklist is not intended to replace an evaluation of a homeowner's historic property or any specific feature by a professional building inspector, contractor, engineer, or architect.

The Project Planning Checklist will assist in classifying the specific type(s) of work being initiated and identify the type of review process required by the City. There are three categories that a project can be

classified as: Maintenance and Repair, Minor Work, and Major Work. Maintenance and Repair can usually be done without prior approval. Minor Work will require an application for Certificate of Review and can be approved by the staff of the Historic Preservation Board. All Major Work projects require a Certificate of Review application and must be approved by the City of Lakeland Historic Preservation Board.

Applications for both Minor Review and Major Review can be completed and submitted online using the City of Lakeland's [iMS system](#).

The attached Inspection Checklist and Project Planning Checklist are not intended as complete lists. In addition to the items listed here, homeowners may identify other components of the structure that may need attention as well. These lists can be used as at the project planning stages; however, it is highly recommended that homeowners consult with architects, engineers, or building contractors where conditions warrant.

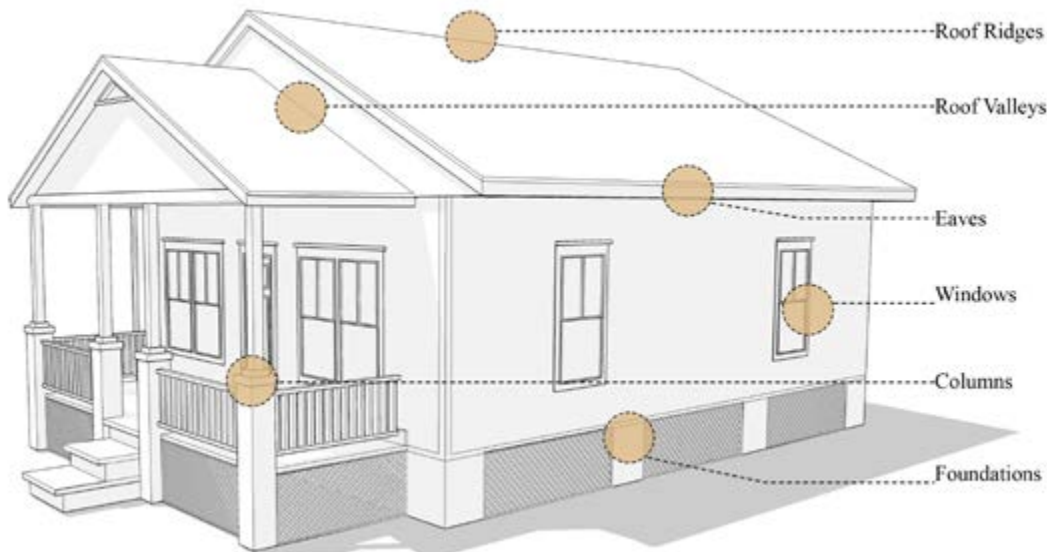

Figure 7.1: Conditions of House Features to be Assessed

7.2 INSPECTION CHECKLIST



INSPECTION CHECKLIST

PROPERTY ADDRESS: _____ DATE: _____

SITE	YES	NO	NOTES
Is there any ponding occurring on the property?			
Are any shrubs or trees too close to the house?			
Do trees or limbs hang over the house's gutters and downspouts?			
ROOF			
Any sign of missing, broken, or warped shingles or tiles?			
Are shingles losing mineral cover, curling, or do edges look thin?			
Any signs of bubbles, separation, or cracking in felt?			
Does the roof ridge sag?			
Is paint peeling or blistering on cornices and overhangs, on the underside?			
FLASHING, GUTTERS, AND DOWNSPOUTS			
Is there loose, missing, or rusted metal flashing at chimneys, valleys, ridges or walls?			
Are there loose, rotted, or missing gutters or downspouts?			
Are gutters or downspouts filled with leaf litter?			
Are gutters holding water or spilling over?			
Do gutter connections leak?			
Is there erosion occurring at the downspout outlets?			
Are downspouts directing water towards the building?			
CHIMNEYS			
Are brick or mortar cracking, crumbling or missing at chimneys?			
Are chimneys built without liners?			
Do fireplaces have any missing or faulty flue dampers?			
Is the chimney missing a cap?			
Is the chimney separating from the wall?			
EXTERIOR WALLS			
Does the wall seem out of plumb, un-level, or are there bulges?			
Are any doors or windows skewed in their openings?			
Are there open joints around doors, windows, or trimwork?			
Is there mold or mildew on the wall surfaces?			
Is any stucco, wood or masonry water stained?			
Where paint is present, is it peeling, cracking, or blistering?			
Is paint powdering or chalking to a dull powdery surface?			
Are there major cracks in the masonry or mortar?			
Is any masonry loose, missing, or deteriorating?			
Is any mortar soft or crumbling?			
Where siding is present, is any dented, faded or corroded?			

PORCHES	YES	NO	NOTES
Are there loose or deteriorated structural or decorative components?			
Are any masonry piers out of plumb or settling?			
Are any of the stairs and railings loose or deteriorated?			
Are any porch floors sloped toward the building, instead of away?			
Is there unusual settling of the porch foundation?			
Are there signs of excessive deterioration or cracking in the porch floor?			
Is there evidence of dry rot or termite damage?			
FOUNDATION			
Is there vertical or diagonal cracking in the masonry?			
Is masonry spalling, loose, or deteriorating?			
Is any mortar soft or crumbling?			
Are any masonry piers out of plumb or settling?			
Does rainwater flow towards any foundations, instead of away?			
Is any organic growth, mold, or mildew attached to the foundation wall?			
Are the vents in the crawl space obstructed?			
CRAWL SPACES			
Is there any sign of vermin infiltration or insect damage?			
Does the area smell of mold or mildew?			
Are any floor supports deteriorated or sagging?			
Are the vents in the crawl space obstructed?			
WINDOWS AND DOORS			
Are any doors or windows deteriorated or in need of paint or finishes?			
Is putty around glass cracking, soft, or pulling away from the glass?			
Do sills, sashes, or frames show signs of deterioration?			
Is there evidence of moisture penetration around openings?			
Is there evidence of dry rot or termite damage?			
Are any window inoperable or difficult to operate?			
Are sashes loose in their frames?			
Are any doors missing weather-striping?			
Are there open joints in need of caulking?			
Are any window or door locks not functioning properly?			
INTERIOR SPACES			
Are wall or ceiling coverings damp, loose, cracked, or deteriorated?			
Is there evidence of water penetration on the ceiling, around window or door openings?			
Do floors sag or bounce when walked on or occupied by heavy weight?			
Are any doors inoperable or difficult to operate?			
Are any of the interior stairs and railings loose or deteriorated?			
Are there any signs of moisture problems in kitchens or bathrooms?			
Is there evidence of dry rot or termite damage?			

ATTIC	YES	NO	NOTES
Are there signs of leaks on the underside of the roof, near openings, or wall junctures?			
Does the attic lack adequate ventilation?			
Do rafters bow?			
Are rafter plates deteriorated?			
Are there signs of vermin infiltration?			
Does the attic lack adequate insulation?			
Is there evidence of dry rot or termite damage?			
HEATING, VENTILATION AND AIR CONDITIONING			
Do filters need to be replaced?			
Is conditioned air distributed unevenly?			
Are any thermostats faulty?			
Are any ducts or pipes missing insulation?			
Any signs of leaks or rust spots?			
ELECTRICAL			
Are any circuit breakers faulty, unlabeled, or incorrectly sized?			
Is wire insulation frayed?			
Are there any faulty light switches or incorrectly wired switches?			
Are there any faulty power outlets?			
PLUMBING			
Is there evidence of leaking under sinks or toilets?			
Are there any leaking or broken water or gas pipes?			
Is the water pressure low or inadequate?			
Are any kitchens, laundries or bathrooms missing Ground Fault Interruption (GFI) outlets?			

NOTE: If one or more of the boxes in this Inspection Checklist is marked, homeowners should determine whether this is an issue that can be done as part of routine maintenance or if it will require a professional who

can further assess the problem. If so, homeowners may need the services of a licensed contractor, repair or installation service, or some other professional with expertise related to a specific house feature.



7.3 PROJECT PLANNING CHECKLIST



PROJECT PLANNING CHECKLIST

PROPERTY ADDRESS: _____ DATE: _____

TYPE OF WORK	MAINTENANCE AND REPAIR	MINOR PROJECTS (HPB STAFF)	MAJOR PROJECTS (HPB/DRC)
1 PAINTING OR REPAINTING*	✓		
2 REPAIR OR REPLACEMENT: SAME MATERIAL, DESIGN AND EXTERIOR APPEARANCE	✓		
3 REPAIR OR REPLACEMENT: NEW OR DIFFERENT MATERIAL, DESIGN AND/OR EXTERIOR APPEARANCE		✓	
Removal of existing modern material to restore historic fabric		✓	
Spot-replace irreparable wood siding with fiber cement siding approved equivalent		✓ <i>Side & rear Facades; and less than 25% per façade</i>	✓ <i>Front façade; and/or greater than 25% per side/rear façade</i>
4 NEW CONSTRUCTION: BUILDING, ACCESSORY STRUCTURE/OUTBUILDING, PORCH, DECK, AND OTHER STRUCTURES		✓ <i>Accessory structures</i>	✓ <i>New building</i>
5 CONSTRUCTION OF ACCESSIBILITY FEATURES			
Exterior staircases/fire escapes		✓ <i>Side or rear façade</i>	✓ <i>Front façade</i>
Handicap ramps		✓ <i>Side or rear façade</i>	✓ <i>Front façade</i>
6 ADDITIONS OR EXPANSIONS OF BUILDING FOOTPRINT			✓

* Minor Review needed for new residential construction and all commercial buildings.

CHANGES IN EXTERIOR 7 MATERIALS, DESIGN OR APPEARANCE			✓
INTRODUCTION OR 8 REMOVAL OF ARCHITECTURAL ELEMENTS			✓
RELOCATION OR 9 DEMOLITION OF BUILDINGS AND OUTBUILDINGS			✓
Removal of outbuilding		✓	
10 ROOFS			
Materials: Repair or replacement	✓ <i>Same material</i>	✓ <i>New/different material**</i>	
Shape or form: Alterations, modifications, or new			✓
Roof Elements: Cresting/finials, dormers, chimneys, cornices/eaves, and gutters/downspouts	✓ <i>Same material</i>	✓ <i>New/different material; alterations/modification/removal/introduction of element</i>	
11 EXTERIOR WALL SIDING			
Materials: Repair or replacement	✓ <i>Same material</i>		✓ <i>New/different material</i>
Removal or introduction of siding material	✓ <i>Removal of modern material to restore historic fabric</i>		✓ <i>Removal of historic fabric or introduction of modern material</i>
12 FOUNDATIONS			
Materials: Repair or replacement	✓ <i>Same material</i>	✓ <i>New/different material</i>	
Cleaning and painting	✓ <i>No Change</i>		
Infill between piers		✓ <i>Does meet guideline</i>	✓ <i>Does not meet guideline</i>

** Roof and roof element replacement with new/different material is subject to Minor Review unless the replacement material is not consistent with the Roof Policy; then would be subject to Major Review.

13 WINDOWS AND DOORS			
Caulking and weather-stripping windows or doors/methods to "weather-tight" structure	✓ <i>No Change</i>	✓ <i>Change in material or design</i>	
Installation or removal of storm windows or doors		✓ <i>Does meet guideline</i>	✓ <i>Does not meet guideline</i>
Replacement of existing windows or doors		✓	
Enclosure or alteration of window or door openings			✓
Shutters: Introduction of shutters where they did not previously exist			✓
Shutters: Replacement of existing shutters with new material or design		✓	
Shutters: Repair or replacement with same material and design	✓		
14 PORCHES			
Materials: Repair or replacement	✓ <i>Same material</i>	✓ <i>Change in material</i>	
Removal or introduction of a porch, deck or elements		✓ <i>Nonvisible side or rear façade</i>	✓ <i>Front or visible side facades</i>
Enclosure of existing porch (i.e. sunroom; creation of new room)			✓
Convert open deck into covered porch with roof, etc. ***			✓
Screening-in of existing porch		✓	
Introduction of Access or safety feature using materials and design appropriate to principal structure		✓ <i>Side or rear façade</i>	✓ <i>Front facades</i>
15 SITE AND LANDSCAPE FEATURES			
Outbuildings/accessory structures			
Repair or replacement of materials or elements	✓ <i>Same material and design</i>	✓	
New construction of accessory structures over 300 square feet			✓

*** This item can be reviewed via Minor Review if on the rear of a structure.

Demolition or relocation		✓	
Walkways, driveways and parking lots			
Walkways and pathways	✓		
Driveways and parking lots	✓ <i>Repair or resurface with same material</i>	✓	
Fences and freestanding walls		✓	
Mechanical systems including but not limited to meters, backflow preventers, generators, and solar panels		✓	
Signage		✓	



8



APPENDIX

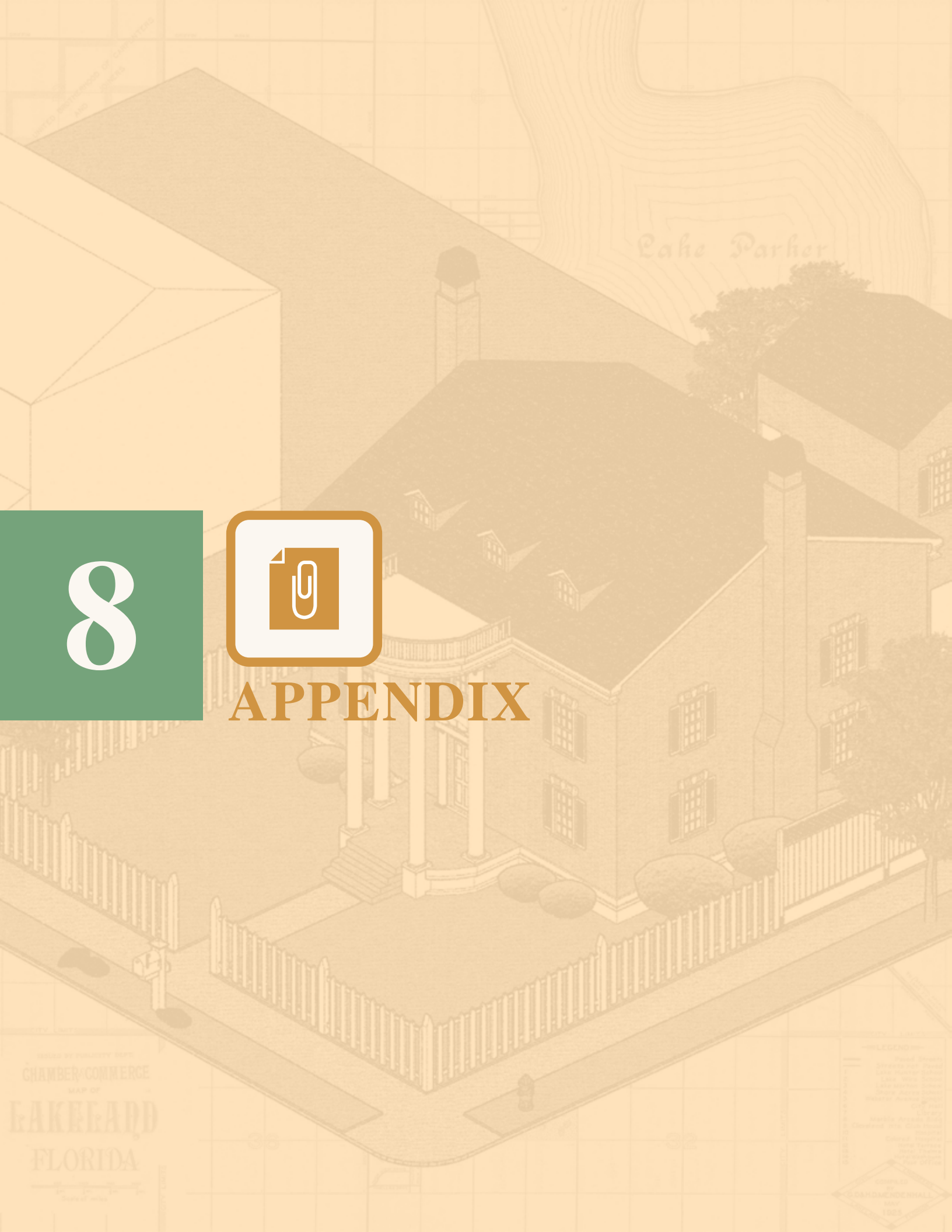

8.1 GLOSSARY

Terms Defined

The meaning of all words, terms, or phrases in this document shall be construed in accordance with the definitions provided in the City of Lakeland Land Development Code, which is incorporated into this document by reference as if set forth in its entirety herein. In the case of a conflict regarding a definition, the Historic District Design Guidelines definition shall control.

I. TECHNICAL DEFINITIONS

Adaptive Use: Rehabilitation of a historic building for a use other than its original use.

Addition: New construction added to an existing building.

Alignment: Arrangement in or adjustment according to a straight line.

Alteration: A change that will affect the exterior architectural or environmental features of a historic landmark or any building, structure, or site within an historic district; includes construction, rehabilitation, restoration and the removal or changing of any building element. Also known as **material change**.

Appropriate: Especially suitable or compatible.

Block Face: A reference to the structures on one side of the street or on the same side of the block.

Building: A structure used to house human activity such as a dwelling or garage.

Certificate of Review: Document certifying that a project has been reviewed and meets the Design Guidelines, and has been authorized to begin by the HPB, DRC, and staff.

Character: The qualities and attributes of any structure, site, street, district, or development project and provide a sense of place, purpose, function, definition, and/or uniqueness.

Compatible: In harmony with location and surroundings.

Configuration: The arrangement of elements and details on a building or structure which help to define its character.

Contemporary: Reflecting characteristics of the current period. Contemporary denotes characteristics which illustrate that a building, structure, or detail was constructed in the present or recent past rather than being imitative or reflective of a historic design.

Context: The setting in which a historic element, site, structure, street, or district exists.

Contributing Building: A building, site, structure, or object within a historic district that contributes to the historical, cultural, and/or architectural qualities and values of the district because it was present during the period of significance and possesses historic integrity, is capable of yielding important information about the period, or it independently meets the National Register of Historic Places criteria.

Demolition: The act or process of destroying, either in whole or in part, a building or structure.

Demolition by Neglect: Term describing the destruction of a building or structure through abandonment or lack of maintenance.

Design: The combination of elements that create the form, plan, space, structure, and style of a building or property.

Design Guidelines: Criteria developed to identify design standards in an area and to help property owners ensure that rehabilitation and new construction respect the character of designated buildings and districts.

DRC: Design Review Committee; a sub-committee of the Historic Preservation Board (HPB).

Element: A material part or detail of a site, structure, street, or district.

Elevation: Any one of the external faces or facades of a building.

Fabric: The physical material of a building, structure, or community, representing an interweaving of component parts.

Façade: Any one of the external faces or elevations of a building.

Form: The shape and structure of a building as differentiated from its substance or material.

Harmony: Pleasing or congruent arrangement.

Height: The distance from the bottom to the top of a building or structure.

Historic District: A geographically definable area with a significant concentration of buildings, structures, sites, spaces, or objects unified by past events, physical development, design, setting, materials, workmanship, sense of cohesiveness or related historical and aesthetic associations. The significance of a district may be recognized through listing by local designation or on the National Register of Historic

Places and may be protected legally through enactment of a local historic district ordinance administered by the Historic Preservation Board.

Historic Imitation: New construction or rehabilitation where elements mimic an architectural style but are not of the same historic period as the existing buildings (historic replica).

HPB: Historic Preservation Board.

Infill: New construction in historic districts on vacant lots or to replace existing buildings.

In-Kind Replacement: To replace a feature of a building with materials of the same characteristics, such as material, texture, dimensions, color, etc.

Integrity: The ability of a property to convey its significance. Condition or description of a property that is physically unaltered or one that retains enough of its historic character, appearance, or ambiance to be recognizable to the period when the property achieved significance. According to the National Register of Historic Places, the seven aspects of integrity are location, design, setting, materials, workmanship, feeling, and association.

Landmark: A building, structure, or site which is identified and designated as a historic resource of particular significance.

Landscape: The totality of the built or human-influenced habitat experienced at any one place. Dominant features are topography, plant cover, buildings, or other structures and their patterns.

Maintain: To keep intact. In the guidelines, ‘maintain’ and ‘retain’ describe the act of keeping an element, detail, or structure and continuing the same level of repair to aid in their preservation.

Massing: The three-dimensional bulk of a building height, width, and depth. Also, the relationships between different volumes of a building or structure.

New Construction: Construction that is characterized by the introduction of new elements, buildings, structures, or additions to existing buildings and structures in historic districts.

Non-Contributing Building: A building, site, structure, or object within a historic district that does not contribute to the historical, cultural, and/or architectural qualities and values of the district because it was not present during the period of significance or because it no longer retains integrity.

Obscured: Covered, concealed, or hidden from view.

Orientation: Set in relation to, or adjusted to, the surroundings, situation, or environment; placed with the most important parts facing in certain directions; set or arranged in a determinate position.

Period of Significance: Span of time in which a property attained historical, architectural, or cultural significance.

Preservation: The act or process of applying measures to sustain the existing form, integrity and materials of a building or structure. It may include initial stabilization work, where necessary, as well as ongoing maintenance of the historic building materials.

Proportion: Harmonious relation of parts to one another or to the whole.

Protection: The act or process of applying measures designed to affect the physical condition of a

property by defending or guarding it from deterioration, loss or attack or to cover or shield the property from danger of injury. In the case of buildings and structures, such treatment is generally of a temporary nature and anticipates future historic preservation treatment; in the case of archaeological sites, the protective measure may be temporary or permanent.

Reconstruction: The act or process of reproducing by new construction the exact form and detail of a vanished building or structure, or part thereof, as it appeared at a specific period in time.

Rehabilitation: The act or process of returning a property to a usable condition through repair or alteration that makes possible a contemporary use while preserving those elements and features of the property which are significant to its historical, architectural and cultural value.

Relocation: The movement of a historic building from its historic location to a new site.

Restoration: The act or process of accurately recovering the form and details of a property and its setting, as it appeared at a particular period in time, by means of the removal of later work or by the replacement of missing earlier work.

Rhythm: Movement or fluctuation marked by the regular occurrence or natural flow of related elements.

Scale: Proportional elements that demonstrate the size of a building, usually relative to what is seen by a pedestrian.

Setting: Refers to the physical environment of a historic property that helps to define its character.

Significant: Having particularly important associations within the contexts of architecture, history, and culture.

Stabilization: The act or process of applying measures designed to reestablish a weather resistant enclosure and the structural stability of an unsafe or deteriorated property while maintaining the essential form as it exists at present.

Streetscape: Generally, the streetscape refers to the character of the street, or how elements of the street form a cohesive environment.

Subordinate: Of less or secondary importance.

Vernacular: A regional form or adaptation of an architectural style.

Visual Continuity: A sense of unity or belonging together that elements of the built environment exhibit because of similarities among them.

II. GLOSSARY OF COMMON HISTORIC PRESERVATION TERMS

Apron: A decorative, horizontal trim piece on the lower portion of an architectural element. Also the sloped portion of a driveway that meets the road.

Arch: A curved construction of wedge-shaped stones or bricks which spans an opening and supports the weight above it. See flat arch, jack arch, segmental arch, and semi-circular arch.

Architrave: The lowermost division of a classical entablature, resting directly on the column capitals and supporting the frieze.

Asphalt Shingles: A type of roofing material composed of layers of saturated felt, cloth or paper, and coated with a tar, or asphalt substance, and granules.

Awning: A projecting roof-like structure sheltering a door or window, often canvas.

Balcony: A railed projecting platform found above ground level on a building.

Baluster: A spindle or post supporting the railing of a balustrade.

Balustrade: An entire railing system with top rail being supported by balusters.

Bargeboard: A decoratively carved board attached to the projecting edges of the rafters under a gable roof; also called a vergeboard.

Bay: The regular division of the façade of a building, usually defined by windows or other vertical elements.

Bead Board: Wood paneling with grooves.

Belt Course: A horizontal band usually marking the floor levels on the exterior facade of a building.

Board and Batten: Siding fashioned of boards set vertically and covered where their edges join by narrow strips called battens.

Bond: The pattern in which bricks are laid to increase the strength or enhance the design.

Bracket: An overhanging member that projects from a structure (such as a wall) and is usually designed to support a vertical load or to strengthen an angle, although can be decorative.

Bulkhead: The structural panels just below display windows on storefronts. Bulkheads can be both supportive and decorative in design. 19th century bulkheads are often of wood construction with rectangular raised panels. 20th century bulkheads may be of wood, brick, tile, or marble construction. Bulkheads are also referred to as kickplates.

Canopy: A projection over a niche or doorway; often decorative or decorated.

Capital: The upper portion of a column or pilaster.

Chamfer: A surface produced by beveling an edge or corner, usually at a 45-degree angle, at the edge of a board or post.

Channel Letters: Channel letters are custom-made metal or plastic letters mounted to the face of a building for exterior signage.

Chimney: A vertical structure containing one or more flues to provide draft for fireplaces, and to carry off gaseous products from fireplaces or furnaces.

Clapboard: Siding consisting of overlapping, narrow horizontal boards, usually thicker at one edge than the other.

Colonnade: A range of columns, whether attached or separated, and supporting an entablature.

Column: A vertical shaft or pillar that supports, or appears to support, weight above.

Coping: A cap or covering to a wall, either flat or sloping, to shed water.

Corbel: In masonry, a projection, or one of a series of projections, each stepped progressively farther

forward with height and articulating a cornice or supporting an overhanging member.

Corbelling: Pattern in a masonry wall formed by projecting or overhanging masonry units.

Corner Board: One of a pair of boards installed with an L-shaped design at an outside corner of a building with wood siding; clapboard or shingle siding usually abuts the sides.

Cornice: The upper most member of a classical entablature. Also used as the term for any projecting or crowning molding at the top of a wall surface.

Cornice Return: The extension of the cornice molding in a new direction, onto a short length of the gable. Course Parallel layers of bricks, stones or wooden blocks in wall construction which may be regular or irregular in their placement.

Cross-gable: A secondary gable roof which meets the primary roof at right angles.

Cupola: A small vaulted structure attached to the roof of a building and supported either upon solid walls or four arches, usually used for ventilation.

Dentils: A row of small tooth-like blocks in a classical cornice.

Eave: The edge of a roof that projects beyond the face of a wall.

EIFS: Exterior Insulated Finish Systems. A type of exterior wall cladding that provides an insulated finished surface and waterproofing in an integrated composite material system intended to simulate the texture and appearance of actual stucco.

Ell (“L”): A wing of a house, generally one room wide and running perpendicular to the principal building.

Engaged Column: A column attached to a wall.

Entablature: Horizontal continuous beam or lintel containing an architrave, frieze, and cornice, and supported by columns or a colonnade.

Façade: An exterior wall.

Fascia: The flat outside horizontal member or band in the entablature of columns or other parts of a building or at the edge of the eaves.

Fenestration: Openings, such as windows and doors, in the walls of a building.

Finial: A projecting decorative element, usually of metal, at the top of a roof turret or gable.

Flashing: Thin metal sheets used to prevent moisture infiltration at joints of roof planes and between the roof and vertical surfaces.

Fluting: Shallow, concave grooves running vertically on the shaft of a column, pilaster, or other surface.

Foundation: The lowest exposed portion of the building wall, which supports the structure above.

Frieze: The horizontal part of a classical entablature between the cornice and architrave, sometimes decorated with sculpture in low relief.

Gable: The triangular portion of a wall enclosing the end of a pitched roof from cornice or eaves to ridge.

Glazing: Glass in windows or the act of fitting and securing glass into window sashes with glazing putty.

Half-Timbered: Exposed timber framing on walls with the spaces filled in with plaster or masonry.

Hood Molding: A projecting molding above an arch, doorway, or window, originally designed to direct water away from the opening; also called a drip mold.

Integral Porch: A porch that is formed from the overhang of the roof. It is not an addition to a house, but is built as a part of the original structure.

Keystone: The wedge-shaped top or center member of an arch.

Knee Brace: A bracket supporting a cantilevered or projecting element. May be straight or curved.

Lattice: An openwork grill of interlacing wood strips used as screening.

Lintel: The horizontal top member of a window, door, or other opening that supports the weight of the wall above it.

Lites: Glass window panes.

Masonry: A construction method that stacks masonry units, such as stones or bricks, and binds them with mortar to form a wall.

Modillion: A horizontal bracket, often in the form of a plain block, ornamenting, or sometimes supporting, the underside of a cornice.

Mortar: A mixture of sand, lime, cement, and water used as a binding agent in masonry.

Mullion: A vertical divider that separates window units.

Muntin: A secondary framing member to divide and hold the panes of glass in a multi-light window or glazed door.

Outrigger: A beam extending outward from a main structure to support the projection of a floor or roof.

Parapet: A low wall usually used around the edge of a flat or low-sloped roof.

Pedestrian-Oriented: Development that is designed with a primary emphasis on the street, sidewalk, and/or connecting walkway access to the site and building, rather than on vehicular access and parking lots.

Pediment: A triangular crowning element forming the gable of a roof or any similar triangular element used over above an entablature, windows, doors, etc.

Pervious: Open to passage or entrance; permeable.

Pier: A vertical structural element, square or rectangular in cross-section.

Pier and Beam Foundation: Foundation consisting of vertical piers spaced at regular intervals that support horizontal beams. A type of raised foundation, as opposed to slab-on-grade foundation.

Pilaster: A rectangular pillar attached, but projecting from a wall, resembling a column.

Pitch: The degree of slope of a roof, usually given in the form of a ratio such as 6:12, or rise:run. Rise is the vertical dimension, and run is the horizontal dimension.

Plinth: Rectangular or square support for columns, pilasters, or door framing.

Porch: A covered entrance or semi-enclosed space projecting from the façade of a building; may be open sided, screened, or glass enclosed.

Porte-Cochere: A roofed structure attached to a building and extending over a driveway, allowing vehicles to pass through. French term meaning “carriage gate.”

Portico: A roofed space, open or partly enclosed, usually forming the entrance and centerpiece of the façade of a building, often with columns and a pediment.

Primary Façade: Generally, the front wall of a building visible from the public right-of-way.

Quoins: A series or pattern of stone, bricks, or wood panels ornamenting the outside corner of a wall.

Rafter: Any of a series of small, parallel beams for supporting a pitched roof. The exposed ends of these beams under the eaves of a roof are called rafter tails.

Repointing: Repairing a masonry wall by the reapplication of mortar between the masonry units.

Reveal: The part of a jamb of a window or door opening that is visible between the outer wall surface and the window or door frame.

Ridge: The peak of a sloped roof.

Roof: The external upper covering of a building including the frame, which can exhibit several shapes that help to define the architectural style of a building. *(Following are Roof Type Definitions)*

- Clipped Gable:** A roof having a hipped end truncating a gable. Also called jerkinhead.
- Flat:** A roof having no slope, or a low sloped pitch for rain runoff. Often includes a parapet wall.
- Gable:** A roof sloping downward in two parts from a central ridge to form a gable at each end.
- Gambrel:** A dual pitched gable roof; a ridged roof divided on each side into a shallower slope above a steeper roof. Also called a barn roof.
- Hipped:** A roof having uniform slopes on all sides.
- Mansard:** A roof with a double slope on all four sides, with the lower slope being almost vertical and the upper almost horizontal.
- Pyramidal:** A roof with four identical sides rising to a central peak.
- Shed:** A roof having a single slope. Also called a slant roof.
- Rusticated:** Rough-surfaced masonry blocks having beveled or blunt edges producing pronounced joints.
- Sash:** The framework in which panes of glass are set in a window or door; also, such a framework together with its panes forming a movable part of a window.
- Secondary Façade:** Walls of a building not considered the Primary Façade.
- Setback:** The open space between the property line of the lot and the nearest projection of a structure. Also, a development standard in building new structures.
- Shingle:** Tile for covering roofs or walls usually of asbestos, asphalt or wood, cut to standard shapes and sizes.
- Siding:** The exterior wall covering of a structure.
- Sill:** Horizontal member at the bottom of a window or door opening.
- Soffit:** The underside of any subordinate member of a building, such as the under surface of an arch, cornice, eave, beam or stairway.
- Spindles:** Slender, elaborately turned wood dowels or rods often used in screens and porch trim.
- Stucco:** Plasterwork applied to the exterior of a structure, usually smooth and painted.
- Surround:** Projecting molding surrounding a wall opening such as a window or fireplace; same as enframent.
- Trim:** The framing of features on a façade. It is usually of a color and material different from that of the adjacent wall surface.
- Veneer:** A thin layer of material, such as wood, brick, or stone, applied to a different material or to a type of construction not ordinarily associated with it, e.g. a facing of brick applied to a frame house.
- Veranda:** A covered porch or balcony on a building's exterior.
- Vernacular:** Description of architecture based on localized needs and construction materials, and reflecting local traditions. Vernacular architecture tends to evolve over time to reflect the environmental, cultural, technological, and historical context in which it exists.

Water Table: A projecting horizontal ledge, intended to prevent water from running down the face of a wall's lower section.

Weatherboard: Wood siding consisting of overlapping boards usually thicker at one edge than the other.

Window: An opening in the wall of a building for admitting light and air, usually fitted with a frame in which are set operable sashes containing panes of glass. *(Following are Window Type Definitions)*

Bay: A window in a wall that projects at an angle from another wall.

Casement: A window with one or two sashes which are hinged at the sides and usually open outward.

Display Window: A window of a store facing onto the public right-of-way used to display merchandise for sale within the store.

Dormer: A window set vertically in a structure projecting through a sloping roof; also: the roofed structure containing such a window.

Double-Hung: A window with two sashes that slide past each other vertically; either both sashes are hung with cord, pulley, and counterweights on each side or the bottom sash has

cords and counterweights on each side; typically, the lower sash is inside the upper sash; number of panes range from one over one to twelve over twelve.

Fanlight: A semi-circular window, usually over a door, with radiating muntins suggesting a fan.

Leaded Glass: A window composed of pieces of glass that are held in place with lead strips; the glass can be clear, colored, or stained.

Sidelight: A narrow window adjacent to a door or wider window, and the same height as the door or window; most often one of a pair flanking an entrance door.

Single-Hung: A window with two sashes where the upper sash is fixed and the bottom is operable; either both sashes are hung with cord, pulley, and counterweights on each side or the bottom sash has cords and counterweights on each side; typically, the lower sash is inside the upper sash; number of panes range from one over one to twelve over twelve.

Storm Window: A secondary window installed to protect and/or reinforce the main window.

Transom: A horizontal window over a door or window.



8.2 HISTORIC DESIGNATION

The City of Lakeland has established processes for the designation of new historic landmarks, districts, and signs in accordance with Articles 4 and 11 of the City of Lakeland Land Development Code (“LDC”). Nominations for determining the eligibility of designating any new historic district, local historic landmark, or historic or landmark sign can be made using the **Application for Historic Designation Eligibility**.

Historic District

Sub-Section 11.4 of the LDC outlines the process of designating new historic districts. Currently there are seven historic districts within Lakeland, as described in Section 3 of this document.

A historic district is a geographically definable area with a significant concentration of buildings, structures, sites, spaces, or objects unified by past events, physical development, design, setting, materials, workmanship, sense of cohesiveness and/or related historical and aesthetic associations. The significance of a historic district may be recognized through listing by local designation and/or on the National Register of Historic Places.

To designate a new district, the HPB or its staff identify a geographical area, typically a neighborhood or historically-platted subdivision, as being suitable for designation as a historic district. The area is then surveyed and studied for the purpose of determining the age and significance of each building, site, or structure within the area. The results of that survey and study are then reported to the HPB which may, following a public hearing, recommend to the City Commission the establishment of a historic district and the boundary thereof. Following receipt of that recommendation, a district may be established by adoption by the City Commission of an ordinance to

that effect. As with the City’s existing historic districts, the HPB has also submitted locally-designated historic districts to the National Register of Historic Places for federal recognition and designation.

While Lakeland citizens may nominate an area to be studied for historic district eligibility, the HPB and its staff make the determination and final decision to pursue historic designation, as this process is labor-intensive and subject to funding availability.

The nomination process for designation of a district on the National Register of Historic Places can be initiated by anyone, but generally must have the consent of the majority of property owners involved. For more information on the National Register nomination process, please see the Florida Division of Historical Resources website (<https://dos.myflorida.com/historical/preservation/national-register/nomination-procedures/>) and the National Park Service website (<https://www.nps.gov/subjects/national-register/how-to-list-a-property.htm>) at the links provided.

Local Historic Landmark

Sub-Section 11.5 of the LDC outlines the general process of designating new historic landmarks. Currently there are sixteen individual historic landmarks within Lakeland, as described in Section 3 of this document.

A local historic landmark is generally a building or site that possesses historic or cultural significance which:

- Reflects the broad cultural, political, economic or social history of the city, state, or nation;
- Is identified with historic persons or important events in local, state, or national history;

- Embodies distinguishing characteristics of an architectural type or is a specimen inherently valuable for the study of a period, style, method of construction or use of indigenous materials or craftsmanship; or
- Is representative of the notable work of a master builder or designer whose individual ability has been recognized or who influenced his/her era.

The HPB may initiate or accept nominations of buildings, sites, and structures for designation as Local Historic Landmarks, and is responsible for reviewing a proposed landmark to determine its local, state, or national significance. A building, site, or structure approved by the HPB for landmark designation will be recommended to the City Commission for such designation upon adoption of a resolution to that effect by the Commission.

The nomination process for designation of a building or site on the National Register of Historic Places can be initiated by anyone, but generally must have the owner's consent of the property involved. For more information on the National Register nomination process, please see the Florida Division of Historical Resources website (<https://dos.myflorida.com/historical/preservation/national-register/nomination-procedures/>) and the National Park Service website (<https://www.nps.gov/subjects/national-register/how-to-list-a-property.htm>) at the links provided.

Historic or Landmark Sign

Sub-Section 4.9.3.1.h.3 of the LDC outlines the general process of designating new historic landmarks. Currently there are seven designated historic or landmark signs within Lakeland.

Nomination of an existing sign as a historic or

landmark sign may be initiated by the HPB, its staff, or any Lakeland citizen. The HPB and its staff will research the sign to determine if it is eligible for historic or landmark designation. When considering the historic or landmark sign designation, the HPB is not empowered to approve an increase in the degree of nonconformity of a sign when approving it for a historic or landmark designation.

To be considered for designation as a historic or landmark sign by the HPB, a sign must be 50 years old and/or possess one or more of the following characteristics:

- The sign must be structurally sound or repairable;
- The sign is associated with historic or cultural figures, events, or places;
- The sign is significant as evidence of the history of a product, business, or service advertised;
- The sign is significant as reflecting the history of a building or the development of a historic district;
- The sign is important in defining the character of a district;
- The sign is characteristic of a specific historic period, such as, but not limited to, gold leaf on glass, neon, or stainless-steel lettering;
- The sign is integral to a building's design or physical fabric;
- The sign is an outstanding example of the sign-maker's art, whether because of its excellent craftsmanship, use of materials, or design;
- The sign is locally recognized as a popular focal point in Lakeland.

Historic or landmark signs must be maintained and kept in good repair, and may not be altered, removed, or covered unless the HPB grants a Certificate of Review to that effect.

8.3 FLORIDA HISTORICAL CONTEXTS RELEVANT TO LAKELAND'S HISTORY

Statehood Period (1845-1861)

The Statehood Period extended from 1845, when Florida entered the Union, until 1861, when it seceded from it. The population remained concentrated in the northern tier of counties. During the peaceful years between two wars, however, the construction of the Florida Railroad from Fernandina to Cedar Key permitted significant settlement of the central peninsula. Like the rest of the South, the Florida economy remained based on the plantation system and slave labor. Slavery dominated national and state politics during the period. The period ended with the disruption of the Union and the commencement of the Civil War.

The architecture of the Statehood Period in many ways resembled that of the Territorial Period (1821-1845). The settled areas of north, middle, and west Florida and Key West still contained the majority of buildings. Some building began in Central Florida, particularly Marion and Alachua counties. Extant buildings dating from the Statehood Period were originally designed as private residences and for educational, religious, transportation, commercial and political uses.

Greek Revival remained the stylistic model for the design of private residences, commercial buildings, and other property types, including the state capitol in Tallahassee. Carpenter Gothic first appeared in Florida during the period. It was popularized nationally in writings and plan books published from the 1830s through the 1850s by Andrew Jackson Downing, Alexander Jackson Davis, and Richard Upjohn. Characteristic of the style was extensive use of sawn wood ornamentation on the barge boards and eaves of the roof, made possible by the

invention of the jigsaw. Upjohn's plans were used in the construction of Episcopal churches from the Statehood Period through the rest of the nineteenth century. Episcopal Churches found in towns along the St. Johns River offer excellent examples of the style.

Wood remained the prevalent building material and log or braced frame walls the principal method of constructing wooden buildings. Commercial saw mills operated in populated areas of Florida. They produced lumber, characterized by vertical saw marks, cut by steam or water powered reciprocating saws.

The construction of the Florida Railroad from Fernandina to Cedar Key resulted in the development of new towns and settlements in the peninsula. The railroad provided an efficient means of transporting building materials to previously inaccessible areas. Products of the industrial revolution, such as corrugated metal and cast iron, appeared in Florida for the first time as did commercially milled wood such as windows, doors, frames, shutters, and ornamental woodwork.

New building types expressed the early stages of a maturing state. Hotels and boarding houses were constructed in significant numbers for the first time and served the state's infant tourist industry. The first schools were designed and built to educate the state's youth. Railroad depots arose beside tracks in settled communities. The settlement of new areas and a growing population resulted in the need for governmental services. The growth of government was symbolized by the construction of the state capitol and the first county courthouses designed as such.

Civil War and Reconstruction Period (1861-1877)

In 1861 Florida seceded from the Union and became one of eleven Confederate states. Florida's cattle and salt industries supplied important provisions for the southern cause. The victory of northern arms spelled the abolition of slavery and, with it, the plantation system. Although little fighting occurred within the state, Florida's economy lay virtually prostrate at the end of the war. During the Reconstruction era (1865-1877), Florida's experience mirrored that of other southern states. Former slaves and northern immigrants wielded powerful influence over local and state politics. Production of cotton and other plantation crops declined, eventually supplanted by citrus cultivation as the principal agricultural activity. Settlement of the peninsula quickened, though the absence of good transportation facilities limited its pace. For the first time, tourists, seasonal residents, and invalids seeking relief from northern winters began arriving in significant numbers.

The disruptions of the Civil War obviously prevented any serious or permanent construction in Florida. With the exception of scattered fortifications, little of consequence was built. Architecturally, the Reconstruction Period that followed the war was a transitional era. New methods of construction, types of buildings, and styles of architecture were introduced to Florida. Circular sawn lumber became common as steam powered mills began to replace manual and reciprocating saw operations. The balloon frame structural system was first used. With it came standardization of board size, which enabled relatively unskilled workers to erect frame buildings both quickly and soundly. Transportation improvements, principally steamboating and some limited rail facilities, led to a wider distribution of materials

such as brick and milled wood products in Florida. However, much of the Florida peninsula remained inaccessible and undeveloped. North, middle, and west Florida remained the principal settled areas.

Extant building types indicate the initial stages of a maturing state. Commercial buildings with cast iron storefronts made their appearance in the 1870s. The first hospitals were constructed.

Buildings constructed during the period contained influences of the previous period and foreshadowed styles that appeared in the subsequent era. Elements of the Greek Revival style persisted. Carpenter Gothic and Gothic Revival in particular continued to exert a significant influence, especially on ecclesiastical architecture, notably Episcopal churches exhibiting the Carpenter Gothic style.

The Reconstruction Period witnessed the early flowering of a variety of materials, methods of construction, types, and styles of architecture in Florida that blossomed in the succeeding era. Greek and Roman influenced architecture began giving way to Victorian period designs. The Italianate appeared particularly on buildings constructed of cast iron.

The architecture of the Victorian era, as opposed to the more conservative architecture of the pre Civil War period, was exotic and eclectic. It was characterized by flamboyant use of decoration, irregular form, multiple roof types, and a variety of materials and colors. Greek and Roman influenced architecture gave way to Gothic, Italianate, Queen Anne, and Second Empire designs. The Italianate appeared particularly on buildings constructed of cast iron. The Reconstruction Period witnessed the early flowering of a variety of materials, methods of construction, types, and styles of architecture in Florida that blossomed in the succeeding era.

Post-Reconstruction Period (1877-1898)

Reconstruction ended in Florida in 1877 with the withdrawal of federal armies. Four years later, in 1881, the State of Florida sold four million acres of public lands to a Philadelphia investor, Hamilton Disston, permitting it to resolve its internal debt problem and distribute land grants in order to promote railroad development. Rail networks soon reached all parts of the state. The rail infrastructure allowed substantial settlement and development of the southern portion of the peninsula for the first time. Railroad development stimulated the state's economy, particularly tourism and citrus cultivation. It was closely linked to hotel construction and the growth of resort communities throughout the peninsula. The first significant industrial development occurred, highlighted by cigar manufacturing.

During the Post Reconstruction period, Florida began rapidly changing from a largely undeveloped frontier to a mature state. Although still behind much of the nation, particularly the northeastern and eastern seaboard states, Florida architecture began to reflect national trends in materials, methods of construction, types of buildings and styles of architecture. Professionally trained architects practiced in the state for the first time. Brick and machine milled lumber, whose shipment was facilitated by the rapidly expanding rail transportation network, became widely distributed. Products of the industrial north such as sheet metal and cast iron were readily available.

Buildings dating from the Post Reconstruction period reflect a broad range of types, styles, materials, size, and designs. They indicate a varied, more complex, diversified, and increasingly sophisticated society. Located throughout the peninsula, their numbers paralleled the course of rail construction along

the Atlantic and Gulf coasts. They embody nationally popular styles, including the Italianate, Queen Anne, and Second Empire.

Transportation, particularly railroads, which lengthened across the Florida peninsula and along the Atlantic coast, keyed the state's overall development. Upon completion of the Florida East Coast Railway to Miami in 1896, a whole new region of the state opened to development. Railroad depots and stations housing passengers and freight services dotted the lines. Hotels soon followed. The design, materials, and construction techniques employed in constructing the hotels exceeded those used for other building types in Florida and, in the case of the Ponce de Leon and Alcazar hotels in St. Augustine and the Tampa Bay Hotel in Tampa, set new national standards. Formally trained architects, such as John M. Carrere, Bernard Maybeck, James Renwick, and Thomas Hastings, were employed by hotel builders and wealthy northern winter residents to design their buildings.

Industrial expansion constituted another a key development of the Post Reconstruction era. In Tampa, Key West, Jacksonville, and St. Augustine cigar manufacturing emerged as a significant industry. The Ybor Factory and cigar factories in Tampa and other Florida cities symbolized the period.

Educational facilities, such as DeLand Hall at Stetson University, the state's first institution of higher education, appeared in unprecedented numbers. With the development of rail transportation and economic and population growth, the need for government services expanded. New counties were created to serve the need and new courthouses and jails followed.

Domestic architecture, particularly that associated with urban areas and wealthy northerners, was

heavily influenced by styles associated with the Victorian period, varied, exotic, and eclectic. It was characterized by flamboyant use of decoration, irregular form, multiple roof types, and a variety of materials and colors. The first great concentrations of domestic architecture developed in neighborhoods such as Springfield and Riverside in Jacksonville, Hyde Park in Tampa, North Hill in Pensacola, and Model Land Company and the Abbott Tract in St. Augustine. Commercial areas, such as those in Fernandina Beach, Orlando, Sanford, and Ybor City, were also heavily influenced by the architecture of the period and products of the industrial revolution such as cast iron and ornamental metal.

Turn of the Century Period/World War I (1898-1918)

The Turn of the Century Period began with the outbreak of the Spanish American War in 1898. Florida benefitted from the war through improved harbors and the billeting of large numbers of troops in a number of coastal communities. Railroad development continued throughout the state. Introduction of the automobile stimulated the beginning of a state road system. Improved transportation facilitated agricultural and industrial expansion and led to dramatic increases in population and tourism. The entry of the United States into World War I signaled the end of the period. Immigration and housing development slowed during the war, but tourism rose when the war in Europe forced Americans to seek vacation destinations in this country.

Florida architecture underwent substantial change during the Turn of the Century period. The flamboyant architecture of the Victorian era gave way to more traditional, conservative influences represented by the Beaux Arts, Colonial Revival, and Classical Revival styles. Also present were early

examples of Mediterranean influenced styles, including the Spanish Colonial Revival and Italian Renaissance, which were to come into full bloom during the 1920s. Contrasting with more traditional styles of architecture were the first examples of the late nineteenth and early twentieth century American movements, such as the Prairie School, the Commercial style, and the Bungalow. Masonry materials became commonplace, particularly in commercial areas.

Improved construction techniques, particularly the use of reinforced concrete and steel frame structural elements, resulted in the first Florida skyscrapers in cities such as Jacksonville, Miami, and Tampa. Architecture as a profession became institutionalized during the period with the founding of the Florida Chapter of the American Institute of Architects in 1915. Middle class ownership of residential buildings expanded proportionately as a result of innovative financial mechanisms.

The extant buildings in Florida identified with the period occupy a wide spectrum of uses and styles. Social clubs, educational buildings, government facilities, retail and wholesale establishments, and transportation buildings, among others, date from the period. A number of railroad stations or depots, symbolic of the state's expanding rail transportation network, also remain. The development of the state's southeastern counties and the steady progress of railroad construction along the coastlines during the period are also reflected in the geographic distribution of buildings.

Transportation remained a key to the state's development. Railroad depots and stations were constructed throughout Florida, particularly in previously undeveloped areas. The railroad, because of its speed and accessibility, supplanted shipping as the principal transportation system in Florida.

Industrial expansion continued during the Turn of the Century Period. Cigar manufacturing and citrus processing were important activities. In Key West and Tarpon Springs, sponge diving and processing developed on a significant scale. Cigar factories, sponge warehouses, sponge boats, and citrus packing houses are important property types associated with the period.

Educational institutions continued to expand. The State of Florida made a significant commitment to higher education by adopting the Beckman Act, which created the University of Florida, Florida Agricultural and Mechanical University, and the Florida State School for Women. Many of the original buildings of these three universities remain. Public and private schools of primary, secondary, and higher education were constructed in unprecedented numbers for the period. Public libraries, many of them funded by the Carnegie Endowment or other charitable organizations, were erected in communities throughout the state. Social institutions, a reflection of a maturing society and an improving quality of life, proliferated. Examples of properties reflecting the trend include fraternal organizations, mutual aid societies, and women's clubs.

With the continued development of rail transportation and economic and population growth, local government expanded. One of the prevailing themes of political history of Florida during the period was county subdivision. As Florida's population grew and new communities developed, residents in outlying areas continually lobbied for division of the state's larger counties into smaller, more manageable units. The expansive size of many counties, the difficulty of travel, and the settlement of previously unpopulated or underpopulated areas following the construction of railroads made reorganization of county government essential. Construction of

courthouses and other municipal and county buildings revealed the expansion of local government during the period.

Domestic architecture grew more conservative, reflecting the influence of classical precedents. The Colonial Revival provided a major influence, even on vernacular architecture. The Bungalow came to dominate residential architecture. It represented a clear break from the preceding period through its size, massing, and interior design. Together with the Prairie School, it symbolized the introduction of the Early Modern Movement in Florida. Prairie School design, never as ubiquitous as the Bungalow, was largely concentrated in Jacksonville, where it was popularized by Henry J. Cloth, the State's first board certified architect. The influence of Cloth and other Florida architects can be seen in rapidly expanding residential neighborhoods such as Springfield and Riverside in Jacksonville, Hyde Park in Tampa, and the Dixieland Subdivision in Lakeland.

Mediterranean architecture gained in popularity. Various influences were linked to the State's Mediterranean derived architecture, including Spanish, Spanish Colonial, Moorish, and Italian Renaissance. Mediterranean based architecture was introduced to Florida through St. Augustine in the Spanish Renaissance Revival style Ponce de Leon and Alcazar hotels and the Venetian Revival style Flagler Memorial Church. Spanish Colonial architecture was popularized nationally at San Diego's Panama California International Exposition in 1915. In Florida, the outstanding example of Mediterranean architecture from the period was Villa Vizcaya, located in Miami and designed in the Italian Renaissance Revival style. Not long after, flamboyant architect Addison Mizner began designing buildings in an eclectic Spanish style in southeast Florida, particularly in Palm Beach and

Boca Raton. The first examples of the style were applied to large and ornate residences. Not until the 1920s did Mediterranean architecture become widely popular.

Commercial architecture proliferated and changed in character during the Turn of the Century Period. A trend toward masonry building materials and innovative construction techniques were major manifestations of the change. Brick and concrete business blocks replaced wooden structures in communities throughout Florida. One of the principal reasons for the trend toward masonry building materials was the actual or potential hazard of fire. As was true in virtually every community in Florida, the first commercial buildings were nearly always wood frame, constructed of extremely flammable pine. As a result of this building practice, fires were common, particularly in commercial areas where buildings were located close to one another. During the late nineteenth and early twentieth centuries the business districts of a number of Florida cities burned. The hazard of fire spurred the use of masonry materials in downtown areas throughout Florida during the early twentieth century. Also for the first time, skyscrapers, built of steel and reinforced concrete, appeared on the skyline of urban areas such as Jacksonville and Tampa.

Florida Boom Period (1919-1929)

Florida experienced an unprecedented period of growth during the post-World War One period, known as the era of the Great Florida Boom. Immediately upon the war's end, real estate activity picked up, soon rising to a frenzied pitch. Property values rose dramatically. In virtually every city and town new subdivisions were platted and lots sold and resold for quick profits. Bank deposits swelled,

and droves of real estate companies set up shop in many towns and cities. State and county road systems expanded rapidly. Southeast Florida, particularly Miami and Palm Beach, entertained the most anxious activity, but few communities in the state escaped the fever. The air began to seep out of the speculative land bubble in 1925. In August of that year the Florida East Coast Railway announced an embargo on freight shipments to south Florida, where ports and rail terminals were clogged with unused building materials. Devastating hurricanes that hit southeast Florida in 1926 and 1928 killed thousands of people and provided a sad, closing chapter to an era of wild excesses, plunging the state into economic depression. Adding to the economic misery, an infestation of the Mediterranean fruit fly devastated groves throughout the state in 1928.

The Florida Boom of the 1920s was a period of unprecedented population growth, economic expansion, and building construction. The Boom was concentrated in Southeast Florida, including Dade, Broward, and Palm Beach counties, and the Gulf Coast, particularly Hillsborough, Pinellas, and Sarasota counties. Jacksonville and St. Augustine also experienced considerable development at the time, as did most communities strung along the highways that carried people into Florida and along its coasts. Towns in the interior, like Sebring, Lake Wales, and Lakeland, also participated in the Boom. Few communities south of Orlando were exempted from the speculative fever.

Building design was strongly influenced by Mediterranean architecture. Developers and architects attempted to capitalize upon Florida's Spanish heritage, probably because it offered a distinctive element to Americans from other states who were reared in the English tradition. Buildings large and small were designed in a variety of "Mediterranean Revival" Styles. Mediterranean Revival has become

a catch all term employed in Florida to describe a building displaying features obviously derived from some part of the Mediterranean basin. Few of these buildings, even those designed by professionally trained architects, were academically correct interpretations of the architecture of Spain, Italy, or Spanish America. Even Addison Mizner, the most prominent architect of the period, was accused of designing in a “Spanish Moorish Romanesque Gothic Renaissance” style. Most designs were eclectic, and many incorporated only minimal features associated with Mediterranean architecture. These might include a light colored stucco exterior finish, round arched window and door openings, and a roof covered with clay tile.

Other styles were found in abundance, for the development of Florida at the time was great enough to encompass every variety of building, large and small. The Bungalow style continued to find acceptance in Florida. Exclusively confined to residential buildings, the style was characterized by a low pitched, gable over gable roof and a rectangular ground plan with the short, or gabled end oriented usually toward the street. Elaborate forms of the Bungalow style of residence continued to appear. The Bungalow exerted a strong influence on the domestic, vernacular architecture of the period as well.

In contrast to styles whose popularity was fading, examples of the Art Deco style began to appear during the late 1920s. By the end of the decade it was becoming popular in public and commercial buildings. The first examples of the style were concentrated largely in the Miami Beach area.

Commercial buildings in Florida constructed at the time reflected a variety of influences. Many, of course, displayed the influence of Mediterranean styles in detailing. Commercial architecture in

Florida continued in general to employ the characteristics of one and two zone composition developed at the turn of the century.

The materials used in construction turned increasingly to brick, concrete, and steel, though numerous vernacular dwelling houses continued to employ wood frame construction techniques. Structural clay tile became common in many areas for the construction of exterior walls. Many buildings were constructed of reinforced concrete. Concrete block, often stamped with a decorative face, came into common usage.

Depression and New Deal Period (1929-1940)

The economic decline that first struck Florida fell within three years upon the nation at large, descending in full measure after the 1929 Wall Street Crash. Between 1929 and 1933, 148 state and national banks in Florida collapsed. By 1933 approximately one out of four Floridians was receiving some type of public relief and assistance. As the decade wore on, relief measures expanded, mostly inspired by the New Deal administration of Franklin Delano Roosevelt. The Works Progress Administration (WPA) provided jobs for professional workers and laborers alike, often employing them to construct roads and buildings. As a result, the nation, the state, and communities by the thousands obtained infrastructural improvements they might otherwise never have attempted for lack of vision or means.

Little building activity occurred during the initial years of the Depression decade of the 1930s. The construction that did take place was largely limited to two types of activities: tourism and public works projects funded by federal programs, such as the

Works Progress Administration. Building types of the Depression and New Deal Period context include tourist related facilities, commercial buildings, and federal, state, and local government buildings.

Private sector development was largely concentrated in a few tourist oriented areas, primarily Miami Beach, but also in Daytona Beach and several other coastal areas. The Art Deco style began to appear in quantity, as did the Art Moderne later in the decade. The Art Deco and Art Moderne were mainly concentrated in Miami Beach, but also can be found in scattered commercial districts throughout the state.

A further significant stimulus to building construction was associated with public works projects, particularly those funded by the federal government. Numerous post offices, federal buildings, auditoriums, armories, and municipal offices were constructed under federal auspices.

As the Depression wore on, the New Deal began introducing innovative mechanisms for financing housing construction, including federally guaranteed home loans. This stimulated home building, generally confined to relatively small houses designed for middle class incomes. The Bungalow, Mediterranean Revival, and Moderne styles were major influences.



Source: Florida Department of State



Source: Library of Congress



Source: floridahistory.org



Source: Alamy Stock Photo

Courtesy and Copyrights: Martin Thomas Photography

8.4 SUSTAINABILITY AND ENERGY RETROFITS

The following information is reprinted from the National Park Service, Technical Preservation Services website: <https://www.nps.gov/tps/sustainability.htm>

Historic preservation is inherently a sustainable practice. The commonly quoted phrase, “the greenest building is the one that is already built,” expresses the relationship between preservation and sustainability. The repair and retrofitting of existing and historic buildings is considered by many to be the ultimate recycling project. In the current era of climate change, the preservation and rehabilitation of historic buildings is instrumental in achieving sustainable development. In fact, recent advances in the life cycle analysis of building construction have found, with limited exception in comparing similar uses, types, and locations, that existing buildings reduce climate impact over the newly built.

Although the mistaken belief persists that older buildings are inefficient, historic buildings often have many built-in energy efficiency features that can be used when looking to make energy improvements. Traditional construction methods and materials used in many of Florida’s historic buildings controlled natural sources of heat, light, and ventilation to respond to the sub-tropical climate. Operable windows, high ceilings, crawlspaces, and ample attic space and vents are features that provide natural ventilation and light that can reduce energy consumption when maintained and used properly, as they reduce the need for mechanical systems and artificial lighting.

Historic buildings also possess what is known as embodied energy; this term represents all energy expended in natural resources extraction, materials production, labor, and transportation in constructing a building. Maintaining a historic building requires

no additional strain on natural resources. The demolition of historic buildings wastes this energy and expends additional energy and resources in adding to the limited capacity of landfills.

Weatherization

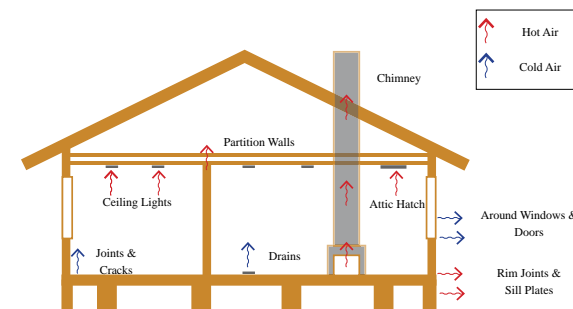

Figure 8.1: Common Air Leaks. Air infiltrates into and out of a home through every hole and crack. About one-third of this air infiltrates through openings in ceilings, walls, and floors

The National Park Service, Technical Preservation Services unit, recommends weatherization as a strategy for improving energy efficiency in older and historic buildings. Weatherizing a historic building should use cost-effective measures in ways that have minimal impact on the historic building's design and materials.

- Get an Energy Audit. Before implementing any energy efficiency measures for a historic building, an energy audit should be undertaken to evaluate the current energy usage and identify deficiencies in the building envelope or mechanical systems. Energy audits are provided by Lakeland Electric free of charge for both residential and commercial properties within Lakeland.

- **Modify User Behavior.** User behavior and climate have a great effect on energy use and should be considered before developing a weatherization and energy efficiency plan.
- **Develop a Plan.** Developing a plan tailored specifically to your building, site, climate, and occupancy will be an effective tool in reducing energy consumption.
- **Check for Air Infiltration.** Air infiltration is the exchange of air through cracks and gaps in the outside shell of a building. There are many simple, low-cost improvements that can reduce air infiltration in your historic building, such as caulking and weather-stripping.
- **Check Windows and Doors.** Historic windows and doors can often be repaired or upgraded to improve energy efficiency and occupant satisfaction.
- **Efficient Systems and Appliances.** The efficiency of mechanical and electrical systems plays a large role in energy use. Ensuring that existing systems are functioning as efficiently as possible or upgrading to new, more-efficient systems can substantially reduce energy consumption with minimal impact on the historic building. When choosing new appliances for your historic building, select products labeled ENERGY STAR, which meet energy efficiency guidelines set by the Environmental Protection Agency and the Department of Energy.
- **Install Insulation.** Installing insulation in certain spaces can be a cost-effective solution to heat loss. However, determining where to install insulation can be a more complex decision than many people realize.
- **Provide Shading.** Installing appropriate awnings on your building or planting deciduous trees can provide shade in the summer and reduce energy needs.

Sound energy improvement measures must take into consideration not only potential energy savings, but also the protection of the materials and features of the historic building. Project planning must entail a holistic approach that considers the entire building envelope, its systems and components, its site and environment, and careful evaluation of the effects of measures undertaken.

Solar Panels

Adding solar panels to historic properties can have a significant impact on the character and visual qualities that convey a property's cultural significance. Solar panel installations should not become prominent new elements that detract from the character-defining features of a building or landscape. To assist property owners, historic preservation commissions, and policy makers, information has been developed to assist in applying the Standards for Rehabilitation to the installation of solar panels on historic properties. Additional guidance is available in *Interpreting the Standards Bulletin 52: Incorporating Solar Panels in a Rehabilitation Project* [<https://www.nps.gov/tps/standards/applying-rehabilitation/its-bulletins/ITS52-SolarPanels.pdf>] and Solar Panels on Historic Properties web page here: <https://www.nps.gov/tps/sustainability/new-technology/solar-on-historic.htm>. Both resources provide examples of compatible and incompatible installations of solar panels on historic buildings.

Green Roofs

Flat or low-slope roofs provide excellent opportunities to introduce a green roof. When planning to add a green or vegetated roof, structural capacity, visibility, and future maintenance must be considered before installation. For more information, refer

to Green Roofs on Historic Buildings [<https://www.nps.gov/tps/sustainability/new-technology/green-roofs.htm>] and Interpreting the Standards Bulletin 54: Installing Green Roofs on Historic Buildings [<https://www.nps.gov/tps/standards/applying-rehabilitation/its-bulletins/ITS54-GreenRoofs.pdf>].



Source: Huntsville Historic Preservation Commission



Source: National Park Service, U. S. Department of the Interior



Source: National Park Service, U. S. Department of the Interior

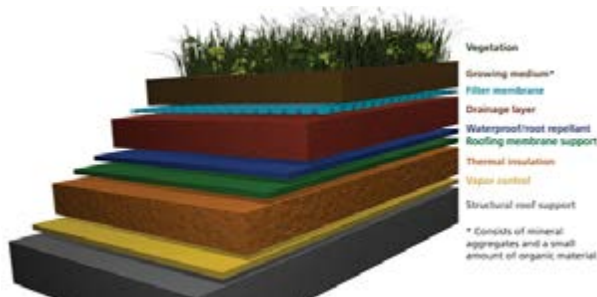

Source: National Park Service, U. S. Department of the Interior

Illustration Credits: Blank Space LLC



Source: National Park Service, U. S. Department of the Interior

Residential Building Energy Efficiency Diagram

This diagram summarizes the strategy and principal direction in the guidelines for a rehabilitation project for energy efficiency on a residential building. These measures enhance energy efficiency while retaining the integrity of the historic structure.

Before central heat and air-conditioning, homes were constructed in concert with the climate and environment and looking to traditional building elements can make your home more efficient today. Before you design a new home or remodel an existing one, consider investing in energy efficiency. You'll save energy and money, and your home will be more comfortable and durable. The planning process is also a good time to look into a renewable energy system that can provide electricity, water heating, or space heating and cooling. You may also want to explore your options for financing an energy-efficient home. In an existing house, the first step is to conduct a home energy assessment to find out how your home uses energy and determine the best ways to cut energy use and costs.



1 SOLAR PANELS

- Collects the sun's energy and converts it into usable energy
- Florida solar incentives, rebates, & tax credits

2 SHUTTERS & AWNINGS

- Effective at reducing solar heat gain in the summer by up to 65% on south-facing windows and 77% on west-facing windows.

3 RAISED FOUNDATIONS

- Resilient in extreme weather and flood-prone areas
- Resistant to moisture and pests
- Good option for coastal properties

4 WINDOWS

- Increased insulation reduces your home's energy usage, while also making your home more comfortable overall.

5 PORCHES

- Porches shelter windows from direct sunlight and pull in cool breezes offering relief from stuffy interiors.

6 ROOF MATERIAL & COLOR

- "Cool" roofs are lighter in color and save energy by reflecting light and heat away rather than absorbing them.

Figure 8.2: Residential Building Energy Efficiency Diagram

Most of the historic houses in Lakeland were constructed before a modern technologies were invented and had to rely on regional or “vernacular” methods to help these structures exist in the Central Florida climate. The design of these structures took into consideration many of the local environment conditions such as intense daylight and heat, humidity, static air flow, rainy periods, localized flooding and occasional hurricanes. As such, many of these structures used local and imported building materials and construction methods. These construction practices were intended to adapt these structures to local environmental conditions and created comfortable living environments for homeowners. Although many of these structures were built for long term occupation and use, they incorporated certain features that can be considered as sustainable, energy efficient and climate responsive at the time of construction.

As many of these structures have been in continuous usage for over a hundred years, many lack features that will that ensure ongoing sustainability by today’s standards.

Historic houses and other structures in the City are considered to have inherent sustainable features resulting from how they were initially constructed. However, many are ideal candidates for different types of enhancements to make them respond better to today’s environmental conditions and ensure thermal comfort for property owners. These include features such as: improved natural passive and heating performance; weather-proofing through sealing gaps around doors and windows; repairs to doors a windows for better operation; use of more energy-efficient doors and windows; attic insulation; renewable energy features; and energy audits.

Recommended Best Practices for Enhancing the Sustainability of Historic Structures:

- Take advantage of the structure’s design for daylighting and natural ventilation.
- Sealing gaps and openings around doors and windows to reduce infiltration to indoor conditioned spaces.
- Repair doors and windows that no longer work properly due to constant use.
- Use of energy efficient doors and windows that are appropriate for the house style to replace original ones that are deteriorated beyond repair.
- Install insulation in walls and attic where possible.
- Conduct energy audit to identify current

levels of usage and performance as they relate to industry standards.

- Install renewable or alternative energy features such as rooftop solar arrays to lessen dependence on the local electric grid.
- Use sustainable features that are compatible with design of the structure and do not alter or detract from its architectural character.

8.5 ENVIRONMENTAL ISSUES

8.5.1 ASBESTOS SHINGLE ROOFING AND SIDING

The following article was originally obtained from the National Park Service, U.S. Department of the Interior.

Title: Keeping a Lid on It: Asbestos-Cement Building Materials.

Author: Amy Lamb Woods, August 2000

While used separately in many prior successful applications, asbestos and cement were first combined in the United States in the early 1900s to form an innovative new building material. Asbestos-cement products were used in a host of applications, which took advantage of its durability, fire resistance, ease in processing, forming, installing, and overall economic benefits. Although often tarnished by the angst associated with asbestos, careful examination of asbestos-cement's history and material characteristics reveal its importance as a twentieth-century building material. In addition, references to applicable regulations and recommendations for proper conservation treatments are addressed.

As early as the 1920s, the National Board of Fire Underwriters recommended that homeowners incur the additional expenses associated with fire-resistant roof coverings as replacements to avoid the hazards associated with wooden shingles. Among the various approved alternatives were asbestos-cement roofing products. This was a milestone in the public's acceptance of the product that a nationally reputable organization recognized and recommended its use.

Originally, roof shingles were manufactured in three typical colors: natural cement gray, Indian red (tile), and blue-black (slate). Two primary designs

produced were Hexagonal (diamond shape) and Dutch lap (similar to wood shingles). Each shingle is held by two nails, with the addition of a storm nail at the apex of the Hexagonal pattern. They are much lighter than tile or slate and weigh only a little more than wooden shingles, allowing for a more economical substructure. Other shapes include: Poilite Straight Cover Slating (square or chamfered corners), Scalloped (three or five scales to a tile), Bell's Pan (ogee shape, or a skewed pan tile), and Endurool (wave pan tile). When asbestos-cement roofing shingles were properly manufactured and installed, the shingles were so durable that the roof would commonly outlast the functional lifespan of the building. Asbestos-cement siding shingles imitated wood siding shingles in shape and appearance, typically available in sizes of twelve by twenty-four inches. These shingles originally came in nondescript tones like gray-green, gray-pink, and Dover white. Textures such as grooved, wood-grained, or smooth were pressed into the large asbestos-cement sheets, then cut to the profile of the design, such as Tapertex (flat horizontal lines), Thatched, or Waveline. They were usually pre-drilled for ease of installation with two to three nails on the bottom of each shingle to secure the panels to the sheathing. Installation was executed from the bottom up. As one row of shingles was nailed, the bottom lip would secure the top of the shingle from the row below. This construction technique allowed ease in replacing shingles, unlike wood or slate shingles that were secured at the top of each shingle. With the advent of asbestos-cement corrugated sheets, the enclosure of factory buildings, warehouses, and train sheds was simple, economical, and effective for either permanent or portable structures. Corrugated asbestos-cement sheets were applied in the same way that corrugated iron was applied, either nailed to wooden strips, bolted to the purlins, or clipped directly to the purlins by clips of hoop-iron or wire. They were available in

standard sheets, twenty-seven and a half inches wide and in lengths of four, five, six, seven, eight, and ten feet. Two primary shapes were Trafford (with peaks) and Fibrotile (with waves). A series of special hardware devices were designed for use with corrugated

sheets so that buildings could be completely encased in the material. Corrugated asbestos-cement sheeting was also used for decorative purposes in uniquely styled buildings of all descriptions.

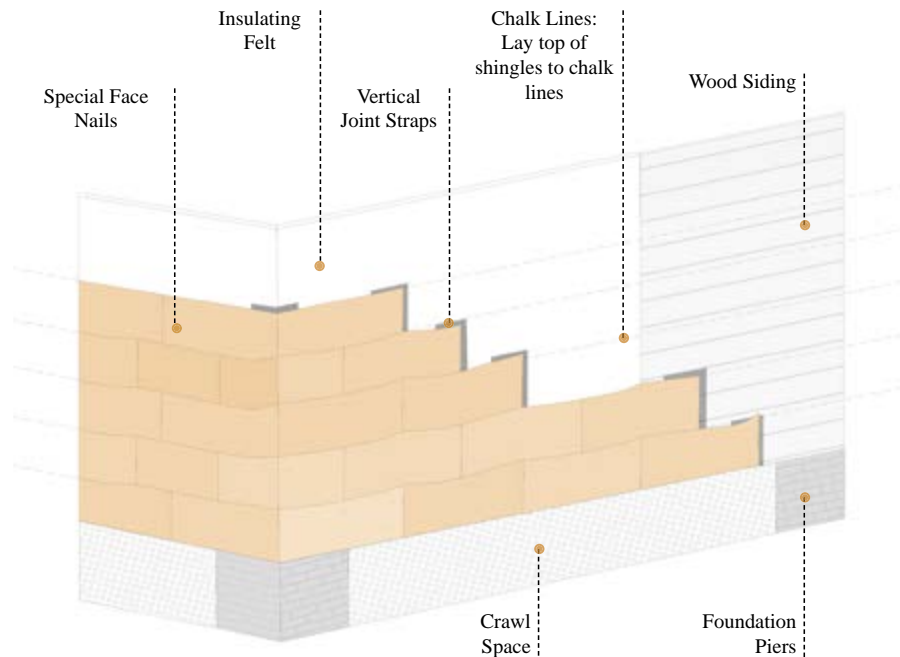

Figure 8.3: *Asbestos-Cement Siding Installation Specifications (McCawley, 1940).*

During the 1940s construction boom, a wider variety of colors became available, including a spackled look, where the colors were impregnated throughout the sheet so they would not powder or peel off. When color change became desirable after installation, owners were encouraged to paint the asbestos-cement products. It was the “attractive home safeguarded with modern asbestos siding, fireproof, rot proof, termite proof” idea that intrigued many Americans during this era. By 1950, approximately one billion square feet of asbestos-cement products had been produced for use in the building industry.

By the time the Environmental Protection Agency (EPA) was established in 1970, the commercial world of asbestos-cement products had expanded into many markets. Annual use of asbestos-cement in the United States continued to climb for another three years before reaching the peak of its popularity, only to plummet to a quick death in 1973 when the EPA implemented the initial ban on asbestos. Asbestos-cement products are still produced in a few countries outside of the United States and are considered a beneficial resource; however now they carry the label “hazardous material” and not “miracle mineral” as they once did.

Asbestos Regulations

Some asbestos fibers, when inhaled, constitute a health hazard leading to asbestosis, a form of lung cancer. These health risks prompted the establishment of strict environmental regulations on working with asbestos. Health risks were shown to be greatest during mining and production processes, but minimal during installation and use of asbestos-cement products. According to the EPA, a material containing asbestos is deemed potentially hazardous only in a friable state, which means when it can be crumbled, pulverized, or reduced to a powder by hand pressure. Asbestos-cement is not considered friable, and therefore not hazardous, because the cement binds the asbestos fibers and prevents their release into the air under normal use conditions. However, asbestos-cement products are classified as friable when severe deterioration disturbs the asbestos or mechanical means are used for chipping, grinding, sawing, or sanding, therefore allowing particles to become airborne.

Maintenance and management guidance for asbestos-containing materials has been formulated by the National Institute for Building Science (NIBS) in their publication "Asbestos Operations and Maintenance Work Practices," and by the EPA in publication 20T-2003, "Managing Asbestos in Place." The two primary institutions that regulate asbestos-containing materials are the EPA and the Occupational Safety and Health Administration (OSHA). Regulations are mandated by the National Emission Standards for Hazardous Air Pollutants (NESHAP), a branch of EPA, under 40 CFR Part 61 Subpart M, and by OSHA under the Federal Register 29 CFR 1926.1101, "Asbestos in Construction Standard." These regulations can change or be superseded by more stringent state and local codes. It

is recommended that these procedures be followed to protect the asbestos-cement materials from becoming friable during any restoration project.

Laws established by federal agencies for non-friable materials are minimal. NESHAP requires no visible emission where-by if a procedure that will disturb the material is being implemented the fibers in the air must be controlled below a visible tolerance. For asbestos-cement, visible emission can easily be controlled by keeping the material adequately wet so that dust does not form. When repairing or replacing, simply spray down the material first, keep the material wet during any abrasive procedures, or use high efficiency particle arresting (HEPA) equipment. Prior to and during demolition use a fire-hose on the structure. OSHA regulations for disturbing non-friable materials include frequent inspection, operation and maintenance training, respirators (only in emergency settings), awareness training, wet methods, and handling procedures. If the material will not be disturbed, no hazard exists and no precautions are required; however, conducting periodic inspections is still advised.

Conservation

Due to the abundance of buildings clad in asbestos-cement products, and the low health risk of the non-friable material, it is necessary to know how to preserve and rejuvenate the material back to a vibrant and usable life. The primary conservation options for asbestos-cement building materials are to maintain and manage in place, repair, replace in part, or abate. The level of deterioration determines the appropriate option to be employed. Abatement, including full removal or encapsulation, should only be used as a final course of action.

Maintain and Manage

Deterioration of asbestos-cement is inevitable, as is eventually the case with most all materials. Maintenance procedures can decelerate deterioration, such as conducting visual inspections to evaluate condition, keeping the material clean, making minor repairs as necessary, and organizing treatment practices that minimize the extent and impact on the material. Also, it is important to maintain the

environment that surrounds the structure and protect the asbestos-cement materials. Examples of protective measures include the planting of shrubs or flower beds between the skirt of the wall and lawns to protect from lawnmower damage, adding a bumper material to the bottom row of siding to reduce vulnerability to cracking and chipping, and keeping branches and debris away from the roof and out of gutters.

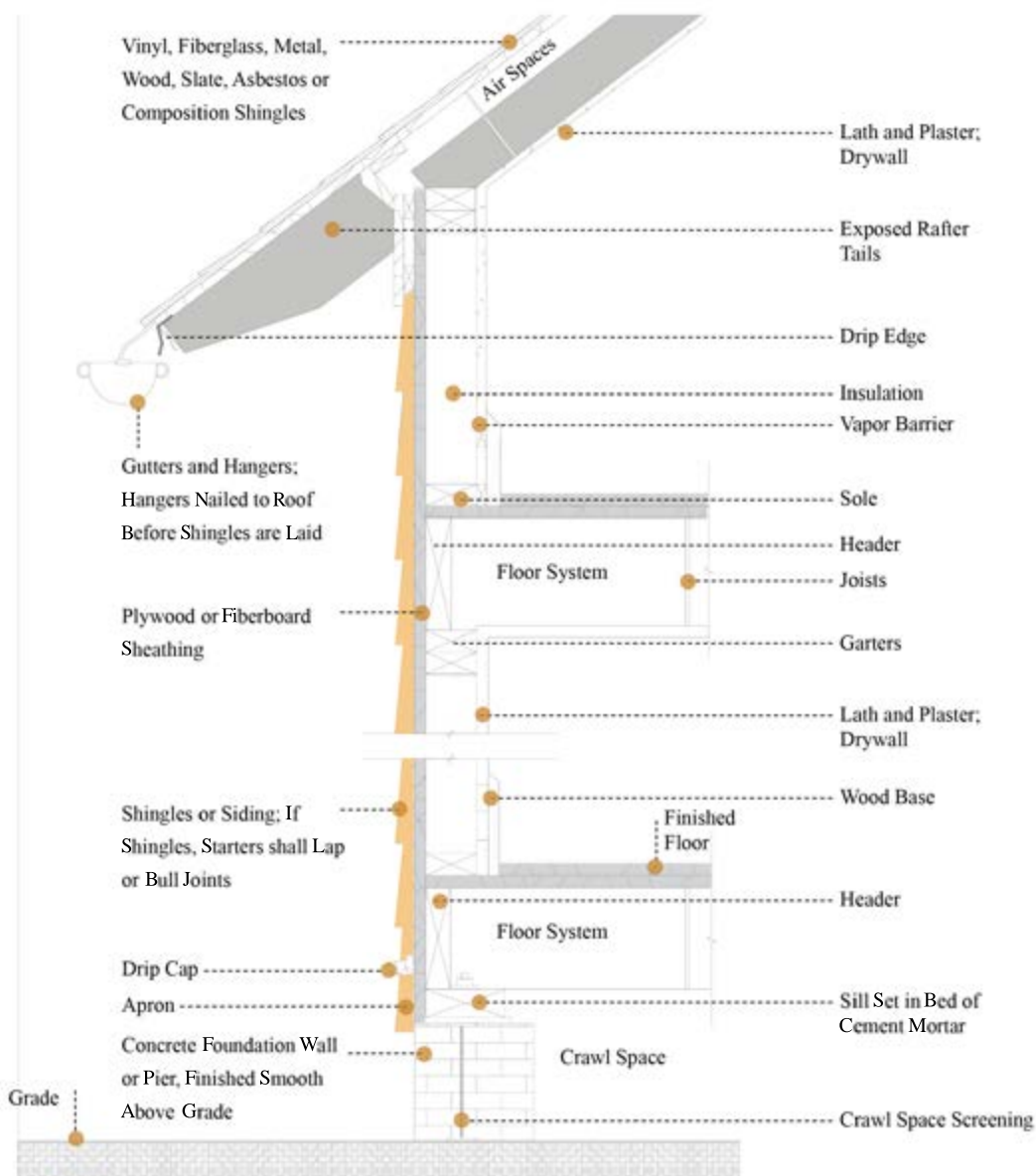

Figure 8.4: Partial Wall Section for Shingle Siding Construction; shows a drip cap and apron in place to protect the bottom edge of siding shingles.

Repair

When repair is the necessary treatment for a deteriorated asbestos-cement product, the least amount of material should be discarded and the most possible amount of original material should be retained. The type and extent of material deterioration associated with asbestos-cement products depends on the cause of the distress and therefore requires investigation and the tailoring of a solution for each case. When repairing the deteriorated materials the gentlest means possible should be used following applicable asbestos regulations, along with repair techniques sympathetic to the existing fabric.

Asbestos-cement is inherently a brittle material with low impact resistance, so even with the added reinforcing given by the long thin asbestos fibers, the material is susceptible to cracking and chipping as generally induced by low impact forces, repeated cyclical loadings, or deteriorated fasteners. In addition to this primary deterioration tendency, manufactured asbestos-cement products can potentially discolor, erode, spall, flake, form efflorescence, and create an environment for biological growth. Guidance for repairing asbestos-cement products is given here for these several distress manifestations.

Cracking

If a crack forms from either impact or fatigue and mandates repair, several techniques can be used depending on the size of the crack. For hairline cracks, work clear epoxy into cracks with a thin object. Epoxy can be susceptible to UV attack and may need to be restored periodically by removing and replacing. For slightly larger gaps, use a grout of Portland cement and water, mixed to a flowing consistency, and tinted to match. For cracks greater than an eighth of an inch, use a thicker grout consistency

or add sand to the mix. The crack may need to be widened to rake out the loose material. Soak the crack with water, then trowel patch the grout into it. Keep the repair damp for a week to promote slow and proper curing and reduce shrinkage.

If the fasteners for the asbestos-cement product have become deteriorated or have broken from corrosion, they should be replaced with a more durable metal. Various metals can be considered for the replacement, but should be compatible with the sheathing. Stainless steel is generally recommended because of its superior corrosion resistance. Fasteners such as nails should be long enough to hold the materials securely (self-clinching nails can help with this).

Discoloration

Discoloration of asbestos-cement products stems from a build-up of surface contamination (such as soiling), stains produced by leaching of other material byproducts (such as corrosion run-off), or a direct change in color due to the environment (such as ultraviolet sun bleaching). These discoloration occurrences typically result from normal weathering, but indicate a chemical reaction that may decrease the strength or durability of the material when neglected over time.

Discoloration should be removed from the asbestos-cement products, and cleaning recommendations generally suggest trying several solutions of varying strengths. After evaluating the results of the trials select the alternative that provides the needed results while using the gentlest means possible without causing adverse reactions to the substrate. Mechanical methods for cleaning can promote asbestos fibers to become airborne, therefore should only be used following asbestos regulations.

To clean light stains, such as dirt, the asbestos-cement products should be washed with a detergent solution or a mixture of one-half cup of trisodium phosphate dissolved in a gallon of hot water. Rinsing with plenty of clear water helps to remove all trace of the cleaning solution. Start the cleaning at the bottom of the wall, working upward in small sections, rinsing immediately, and keeping the shingles below wet, otherwise, dirty water can drip down over dry surfaces and leave streaks almost impossible to remove later.

Recommendations for stains such as rust, are to dissolve one part of sodium citrate in six parts of commercial glycerin. Mix part of this with inert dry clay, such as diatomaceous earth, to form a poultice and apply as a thick layer. When the paste is dry, replace with fresh paste or moisten with the remaining liquid. Complete removal of the stains may require a week or longer. A ten percent oxalic acid solution has also been found to successfully remove rust from cementitious products. If the substrate, metal fixtures, or other adjacent objects are causing staining they should be cleaned and coated or replaced.

If the stain cannot be removed, another option is painting the asbestos-cement products. Painting is an especially good solution if the material was originally painted, but adds a maintenance factor. Oil based paints and varnishes are not chemically compatible with cementitious materials. High quality alkali-resistant and weather resistant exterior paint (i.e., 100% acrylic coating) should be used on exterior asbestos-cement materials, or use pigmented shingle stain. Before being painted, asbestos-cement surfaces should be cleaned, then primed with an alkali-resistant primer.

Eroding, Spalling, or Flaking

Erosion removes cement particles and can result in the release of asbestos fibers, leaving the material with less reinforcement. Due to the high density, low permeability, and low porosity of the material, this tendency is virtually unnoticeable. However, erosion can become a more serious problem under regular and extremely harsh weather conditions. If intense erosion occurs, the durability of the material can be compromised.

Although rare, spalling or flaking occurs when elements permeate beneath the surface of the asbestos-cement material and then expand, causing a portion of the material to be released due to the resulting stress. As the moisture content increases, more severe deterioration can occur. This deterioration is more likely to occur in products that were cured at lower temperatures and therefore are more vulnerable to water penetration. To control eroding, spalling, or flaking, chemical consolidants and/or breathable sealers (most commonly silane) can be applied to strengthen the material while adding water protection. Testing is critical since consolidants and sealers can promote spalling if water is getting in through the backside of the material. A grout or latex-patch may also be considered, but must be compatible with, and typically softer than, the asbestos-cement material to form a good bond and not promote increased spalling. This repair procedure can be tricky and may lead to constant patching, and may be unsightly if not done with extreme care. For these types of deterioration tendencies, the material may be better off left alone or partially replaced.

Efflorescence

Efflorescence appears on many Portland cement products that are exposed to weathering. This form of crystalline growth indicates that water is passing through the material, which can promote deterioration of the asbestos-cement, in addition to making it unsightly. Generally, this is seen at the beginning of the material's life, where rain and weathering tend to remove it over time.

To clean efflorescence deposits, the surface should first be dry brushed with soft bristles, not scratching the surface. If efflorescence still remains, test to see if it is water soluble or acid soluble. If water soluble, the wall should be wiped with a wet sponge or brush (a light detergent can also be added). A hose can be used, but spray the water in a downward direction as perpendicular force will drive the efflorescence back into the material. If acid soluble, clear 'white' vinegar, acetic acid, phosphoric acid, or similar proprietary products diluted in water should be used. It is recommended to wet the surface with solution, then apply solution more liberally on the asbestos-cement. After two or three minutes, scrub using a fiber brush with more solution, then rinse extremely well with clear water. Safety precautions provided on the product labels should be followed, and again tested before commencing extensive application as adverse effects or discoloration may occur. Pitting from chemicals will increase dirt build-up and water permeability, decreasing the durability of the material.

Biological Growth

Biological growth on the exterior of asbestos-cement can be a problem in sheltered environments or on northern exposures. Shade trees located close

to a building can shield sunlight and result in prolonged dampness of the asbestos-cement building product and promote biological formations, such as moss and algae. Not only are the growths unsightly, but they can stimulate surface disintegration, dissolution, and staining.

The presence of moss and other fungi growth signals that the moisture content of the material is high and therefore an attack by a more damaging biological species could occur. It is not only important to remove the growth from the asbestos-cement material, but also to remove the environment that is causing the growth. To eliminate biological growth, a strong mixture of weed killer and water could be tested. If unsuccessful, a solution of four parts bleach, one-part trisodium phosphate, and twelve parts warm water is recommended. After a week or so when the moss has turned brown and dry, it should be brushed off. In the case of ivy this technique is sometimes not helpful in removing the thousands of tiny roots left after the ivy has been pulled off; a stronger product may be needed (i.e.,



Figure 8.5: Asbestos-cement products most commonly deteriorate by cracking and chipping. These kinds of deterioration are not typically feasible to repair, and therefore it is recommended that a non-asbestos fiber cement piece be used as a replacement (photo by author).



Figure 8.6: Replacement non-asbestos fiber-cement shingles in place, before being painted and after (photo by author).

copper sulfate). It is important to remember that biological growths differ widely and so do the processes for their removal. Testing various products and selecting appropriately is highly encouraged.

Replacement

Since asbestos-cement products were manufactured in standard sizes, shapes, colors, and textures, partial replacement is well suited for implementation. This process is acceptable when part of, or pieces of, the existing asbestos-cement building material have deteriorated to such a degree that it is much more feasible to replace than repair. Since the United States no longer produces asbestos-cement products, an alternative material should be selected to match the original.

Some materials that have been manufactured to replicate asbestos-cement building components are non-asbestos reinforced cement, fiberboard with asphalt, fiberglass, metal, and vinyl. For the purposes of preservation, one of the non-asbestos reinforced cement products is most appropriate.

Many varieties of non-asbestos reinforced cement or fiber-cement are currently available. Fibers that have been introduced with cement include: steel, glass,

polypropylene, wood (these four being the most common), acrylic, akwara, alumina, carbon, cellulose, coconut, kevlar, nylon, perlon, polyethylene, rock wool, and sisal. Combinations of fibers are currently undergoing research in order to get properties closely matching those of asbestos. Several companies manufacture products that replicate asbestos-cement roofing and siding shingles, flat sheets, and corrugated sheets. Some of these manufacturers include: Supradur Manufacturing Company, Cement Board Fabricators, U.S. Architectural Products, Inc., Re-Con Building Products, and GAF Materials Corp. The fiber-cement products replicate the size, shape, thickness, and structure, along with texture and color of many of the asbestos-cement products previously available. Where color matching is not found, an alternative is to replace in size and shape then paint over the entire structure for a uniform appearance. In addition, the hardware and the installation procedures for these products are similar to those for asbestos-cement products due to their similar characteristics and proportions.

Conclusion

Asbestos-cement products were developed in an era of ingenuity for creating easy to install and

economic building materials. Although asbestos-cement has acquired a poor reputation by association of its title, it has not gained that reputation through a lack of durability or utility. In order to preserve this twentieth-century material, understanding what makes, or does not make, asbestos a hazard is truly important. In this case, no hazard is created when asbestos-cement building materials are sound and left

in place, or when treatments incorporate non-abrasive means.

Also reference the Technical Preservation Services Brief concerning Asbestos-Cement Shingles here: <https://www.nps.gov/tps/education/roofingexhibit/asbestoscement.htm>

8.5.2 LEAD PAINT ABATEMENT

The following section was obtained from Preservation Brief 37: Appropriate Methods for Reducing Lead Paint Hazards in Historic Housing, a National Park Service, U.S. Department of the Interior, publication available freely online at <https://www.nps.gov/tps/how-to-preserve/briefs/37-lead-paint-hazards.htm#summary>. Authors: Sharon C. Park, AIA and Douglas C. Hicks.

Lead-based paint, a toxic material, was widely used in North America on both the exteriors and interiors of buildings until well into the second half of the twentieth century. If a "historic" place is broadly defined in terms of time as having attained an age of fifty years, this means that almost every historic house contains some lead-based paint. In its deteriorated form, it produces paint chips and lead-laden dust particles that are a known health hazard to both children and adults. Children are particularly at risk when they ingest lead paint dust through direct

hand-to-mouth contact and from toys or pacifiers. They are also at risk when they chew lead-painted surfaces in accessible locations. In addition to its presence in houses, leaded paint chips, lead dust, or lead-contaminated soil in play areas can elevate a child's blood lead level to a degree that measures to reduce and control the hazard should be undertake.

The premise of this Preservation Brief is that historic housing can be made lead-safe for children without removing significant decorative features and finishes, or architectural trimwork that may contribute to the building's historic character. Historic housing—encompassing private dwellings and all types of rental units—is necessarily the focus of this Brief because federal and state laws primarily address the hazards of lead and lead-based paint in housing and day-care centers to protect the health of children under six years of age. Rarely are there mandated requirements for the removal of lead-based paint from non-residential buildings.



PHOTO: A large-scale historic rehabilitation project incorporated sensitive lead-hazard reduction measures. Interior walls and woodwork were cleaned, repaired, and repainted and compatible new floor coverings added. The total project was economically sound and undertaken in a careful manner that preserved the building's historic character. Before:left, after:right. Photos: Landmarks Design Associates

Lead in Historic Paints

Lead compounds were an important component of many historic paints. Lead, in the forms of lead carbonate and lead oxides, had excellent adhesion, drying, and covering abilities. White lead, linseed oil, and inorganic pigments were the basic components for paint in the 18th, 19th, and early 20th centuries. Lead-based paint was used extensively on wooden exteriors and interior trimwork, window sash, window frames, baseboards, wainscoting, doors, frames, and high gloss wall surfaces such as those found in kitchens and bathrooms. Almost all painted metals were primed with red lead or painted with lead-based paints. Even milk (casein) and water-based paints (distemper and calcimines) could contain some lead, usually in the form of hiding agents or pigments. Varnishes sometimes contained lead. Lead compounds were also used as driers in paint and window glazing putty.

In 1978, the use of lead-based paint in residential housing was banned by the federal government. Because the hazards have been known for some time, many lead components of paint were replaced by titanium and other less toxic elements earlier in the 20th century. Since houses are periodically repainted, the most recent layer of paint will most likely not contain lead, but the older layers underneath probably will. Therefore, the only way to accurately determine the amount of lead present in older paint is to have it analyzed.

It is important that owners of historic properties be aware that layers of older paint can reveal a great deal about the history of a building and that paint chronology is often used to date alterations or to document decorative period colors. Highly significant decorative finishes, such as graining, marbleizing, stenciling, polychrome decoration, and murals should be evaluated by a painting conservator

to develop the appropriate preservation treatment that will stabilize the paint and eliminate the need to remove it. If such finishes must be removed in the process of controlling lead hazards, then research, paint analysis, and documentation are advisable as a record for future research and treatment.

Planning for Lead Hazard Reduction in Historic Housing

Typical health department guidelines call for removing as much of the surfaces that contain lead-based paint as possible. This results in extensive loss or modification of architectural features and finishes and is not appropriate for most historic properties. A great number of federally assisted housing programs are moving away from this approach as too expensive and too dangerous to the immediate work environment. A preferred approach, consistent with The Secretary of the Interior's Standards for the Treatment of Historic Properties, calls for removing, controlling, or managing the hazards rather than wholesale, or even partial-removal of the historic features and finishes. This is generally achieved through careful cleaning and treatment of deteriorating paint, friction surfaces, surfaces accessible to young children, and lead in soil. Lead-based paint that it not causing a hazard is thus permitted to remain, and, in consequence, the amount of historic finishes, features, and trimwork removed from a property is minimized.

Because the hazard of lead poisoning is tied to the risk of ingesting lead, careful planning can help to determine how much risk is present and how best to allocate available financial resources. An owner, with professional assistance, can protect a historic resource and make it lead-safe using this three-step planning process:

1. Identify the historical significance of the building and architectural character of its features and finishes.

The historical significance, integrity, and architectural character of the building always need to be assessed before work is undertaken that might adversely affect them. An owner may need to enlist the help of a preservation architect, building conservator or historian. The State Historic Preservation Office (SHPO) may be able to provide a list of knowledgeable preservation professionals who could assist with this evaluation.

Features and finishes of a historic building that exhibit distinctive characteristics of an architectural style; represent work by specialized craftsmen; or possess high artistic value should be identified so they can be protected and preserved during treatment. When it is absolutely necessary to remove a significant architectural feature or finish—as noted in the first two priorities listed below—it should be replaced with a new feature and finish that matches in design, detail, color, texture, and, in most cases, material.

Finally, features and finishes that characterize simple, vernacular buildings should be retained and preserved; in the process of removing hazards, there are usually reasonable options for their protection.

Wholesale removal of historic trim and other seemingly less important historic material undermines a building's overall character and integrity and, thus, is never recommended.

For each historic property, features will vary in significance. As part of a survey of each historic property, a list of priorities should be made, in this order:

- Highly significant features and finishes that should always be protected and preserved;
- Significant features and finishes that should be carefully repaired or, if necessary, replaced in-kind or to match all visual qualities; and
- Non-significant or altered areas where removal, rigid enclosure, or replacement could occur.

This hierarchy gives an owner a working guide for making decisions about appropriate methods of removing lead paint.

2. Undertake a risk assessment of interior and exterior surfaces to determine hazards from lead and lead-based paint.

While it can be assumed that most historic housing contains lead-based paint, it cannot be assumed that it is causing a health risk and should be removed. The purpose of a risk assessment is to determine,



PHOTO: The paint chronology of this mantel, seen in the exposed paint layers in the left corner, proved it had been relocated from another room of the house. To remove a significant feature's paint history and the evidence of its original sequence of color by stripping off all the paint is inappropriate - and unnecessary - as part of a lead hazard reduction project. Careful surface preparation and repainting with lead-free top coats is recommended. Photo: NPS Files.

through testing and evaluation, where hazards from lead warrant remedial action. Testing by a specialist can be done on paint, soil, or lead dust either on-site or in a laboratory using methods such as x-ray fluorescence (XRF) analyzers, chemicals, dust wipe tests, and atomic absorption spectroscopy. Risk assessments can be fairly low-cost investigations of the location, condition, and severity of lead hazards found in house dust, soil, water, and deteriorating paint. Risk assessments will also address other sources of lead from hobbies, crockery, water, and the parents' work environment. A public health office should be able to provide names of certified risk assessors, paint inspectors, and testing laboratories. These services are critical when owners are seeking to implement measures to reduce suspected lead hazards in housing, day-care centers, or when extensive rehabilitations are planned.

The risk assessment should record:

1. The paint's location
2. The paint's condition lead content of paint and soil
3. The type of surface (friction; accessible to children for chewing; impact)
4. How much lead dust is actively present
5. How the family uses and cares for the house
6. The age of the occupants who might come into contact with lead paint

It is important from a health standpoint that future tenants, painters, and construction workers know that lead-based paint is present, even under treated surfaces, in order to take precautions when work is undertaken in areas that will generate lead dust. Whenever mitigation work is completed, it is important to have a clearance test using the dust wipe method to ensure that lead-laden dust generated

during the work does not remain at levels above those established by the Environmental Protection Agency (EPA) and the Department of Housing and Urban Development (HUD). A building file should be maintained and updated whenever any additional lead hazard control work is completed.

Hazards should be removed, mitigated, or managed in the order of their health threat, as identified in a risk assessment (with 1. the greatest risk and 8. the least dangerous):

1. Peeling, chipping, flaking, and chewed interior lead-based paint and surfaces
2. Lead dust on interior surfaces
3. High lead in soil levels around the house and in play areas (check state requirements)
4. Deteriorated exterior painted surfaces and features
5. Friction surfaces subject to abrasion (windows, doors, painted floors)
6. Accessible, chewable surfaces (sills, rails) if small children are present
7. Impact surfaces (baseboards and door jambs)
8. Other interior surfaces showing age or deterioration (walls and ceilings)

3. Evaluate options for hazard control in the context of historic preservation standards.

The Secretary of the Interior's Standards for the Treatment of Historic Properties can help guide suitable health control methods. The preservation standards call for the protection of historic materials and historic character of buildings through stabilization, conservation, maintenance, and repair. The rehabilitation standards call for the repair of historic materials with replacement of a character-defining feature

appropriate only when its deterioration or damage is so extensive that repair is infeasible. From a preservation standpoint, selecting a hazard control method that removes only the deteriorating paint, or that involves some degree of repair, is always preferable to the total replacement of a historic feature.

By tying the remedial work to the areas of risk, it is possible to limit the amount of intrusive work on delicate or aging features of a building without jeopardizing the health and safety of the occupants. To make historic housing lead-safe, the gentlest method possible should be used to remove the offending substance—lead-laden dust, visible paint chips, lead in soil, or extensively deteriorated paint. Overly aggressive abatement may damage or destroy much more historic material than is necessary to remove lead paint, such as abrading historic surfaces. Another reason for targeting paint removal is to limit the amount of lead dust on the work site. This, in turn, helps avoid expensive worker protection, cleanup, and disposal of larger amounts of hazardous waste.

Whenever extensive amounts of lead must be removed from a property, or when methods of removing toxic substances will impact the environment, it is extremely important that the owner be aware of the issues surrounding worker safety, environmental controls, and proper disposal. Appropriate

architectural, engineering and environmental professionals should be consulted when lead hazard projects are complex. Within the context of the historic preservation standards, the most appropriate method will always be the least invasive.

Summary and References

Reducing and controlling lead hazards can be successfully accomplished without destroying the character-defining features and finishes of historic buildings. Federal and state laws generally support the reasonable control of lead-based paint hazards through a variety of treatments. The key to protecting children, workers, and the environment is to be informed about the hazards of lead, to control exposure to lead dust and lead in soil, and to follow existing regulations. In all cases, methods that control lead hazards should be selected that minimize the impact to historic resources while ensuring that housing is lead-safe for children.

Also reference the U.S. Department of Housing and Urban Development’s online resource regarding Historic Homes and Lead Paint Abatement here: <https://www.hud.gov/sites/documents/LBPH-20>. PDF



8.6 RESOURCES AND WORKS REFERENCED

Architecture

American Vernacular Design 1870-1940. Herbert Gottfried & Jan Jennings. Van Nostrand Reinhold Co. New York. 1985.

Architecture and Ornament: A Visual Guide. Anthony White and Bruce Robertson. Design Press. New York. 1990.

A Field Guide to American Houses: The Definitive Guide to Identifying and Understanding America's Domestic Architecture. Virginia Savage McAlester. New York. Alfred A. Knopf. 2017.

A Visual Dictionary of Architecture. Francis D. K. Ching. Second Edition. John Wiley & Sons, Inc. New Jersey. 2011.

Dictionary of Building Preservation. Ward Bucher, A.I.A. John Wiley & Sons, Inc. New York. 1996.

Encyclopedia of American Architecture. Robert T. Packard, A.I.A. McGraw-Hill, Inc. New York. 1995.

Get Your House Right: Architectural Elements to Use & Avoid. Marianne Cusato, Ben Pentreath, Richard Sammon, and Leon Krier. New York. Sterling Publishing. 2007.

Missing Middle Housing. Daniel Parolek with Arthur C. Nelson. Island Press. Washington. 2020.

The Ranch House in Georgia. Guidelines for Evaluation. New South Associates. 2010. https://is-suu.com/georgiashpo/docs/ranch_house_guidelines

The Visual Dictionary of American Domestic Architecture. Rachel Carley. Henry Holt and Company, LLC. New York. 1994.

Cultural Landscapes

National Park Service. Technical Preservation Services. Preservation Brief 36: Protecting Cultural Landscapes: Planning, Treatment, and Management of Historic Landscapes. Charles A. Birnbaum, ASLA. September 1994. <https://www.nps.gov/tps/how-to-preserve/briefs/36-cultural-landscapes.htm>

The Cultural Landscape Foundation (TCLF). www.tclf.org.

Design Guidelines from Other Municipalities

City of Fernandina Beach Downtown Historic District Design Guidelines. Thomason and Associates Preservation Planners. Nashville, Tennessee. 2013.

City of Gainesville Historic Preservation, Rehabilitation, and Design Guidelines. City of Gainesville, Florida. 1994.

City of San Antonio Design Historic Design Guidelines. San Antonio Office of Historic Preservation. 2012.

Guidelines for Evaluation and Documentation for National Register of Historic Places. National Register Bulletin; Historic Residential Suburbs. US Department of Interior . National Parks Service.

St. Petersburg's Design Guidelines for Historic Properties. City of St. Petersburg and Renker Eich Parks Architects. 2017.

Village of Newburgh Heights. Residential and Commercial Design Guidelines. Cuyahoga County. Planning Commission. Cleveland, Ohio. 2001.

Economics

Economic Impacts of Historic Preservation in Florida: Update, 2010. Center for Governmental Responsibility, University of Florida Levin College of Law. Center for Urban Policy Research, Edward J. Bloustein School of Planning & Public Policy, Rutgers, The State University of New Jersey.

The Economics of Historic Preservation. Donovan D. Rypkema. Washington. The National Trust for Historic Preservation. 1994.

Emergency Preparedness

Disaster Mitigation for Historic Structures: Protection Strategies. Florida Department of State, Division of Historical Resources; Florida Division of Emergency Management; Prepared by 1000 Friends of Florida. 2008.

Hurricane Preparedness and Recovery for Owners of Historic Properties. Historic Charleston Foundation. Accessed from The National Trust for Historic Preservation's Resource Library 2020. (<https://forum.savingplaces.org/viewdocument/hurricane-preparedness-and-recovery>).

Resilient Heritage: Protecting Your Historic Home from Natural Disasters. National Park Service's Center for Preservation Technology and Training (NCPTT) and the Louisiana Division of Historic Preservation (LDHP). May 2015.

Historic Preservation

Advisory Council on Historic Preservation. www.achp.org

National Park Service. www.nps.gov

National Park Service. Technical Preservation Services. Preservation Briefs No. 1 - 50 (the Briefs provide advice on the treatment individual historic building materials and/or architectural elements). <https://www.nps.gov/tps/how-to-preserve/briefs.htm>

Old-House Journal. Monthly. Old-House Journal Corporation, 435 Ninth Street, Brooklyn, New York, 11215.

Restoring Your Historic House. Scott D. Hanson and David Clough. Tilbury House Publishers. Thomaston, Maine. 2019.

Secretary of the Interior's Standards for the Treatment of Historic Properties with Guidelines for Preserving, Rehabilitating, Restoring & Reconstructing Historic Buildings. US Department of the Interior, National Park Service, Technical Preservation Services. Revised by Anne Grimmer. Washington, D.C. 2017.

The National Trust for Historic Preservation. www.savingplaces.org

Historic Preservation in Florida

Florida Division of Historical Resources. <https://dos.myflorida.com/historical/>

Florida Trust for Historic Preservation. <https://www.floridatrust.org/>

Historic Lakeland, Inc. <http://www.historiclakeland.org/>

The Craftsman Blog. <https://thecraftsmanblog.com/>

Lakeland History

A Guide to Historic Lakeland, Florida. Steve Ratjar. The History Press. 2007.

Florida Memory, State Library and Archives of Florida. www.floridamemory.com

Lakeland: A Pictorial History: A Revised Edition of Yesterday's Lakeland. Hampton Dunn. Donning Co. 1990.

Lakeland History Room, Lakeland Public Library. 100 Lake Morton Drive, Lakeland, Florida. Digital Archive: <https://cdm15809.contentdm.oclc.org/digital/>

Landscaping

Florida-Friendly Landscaping. University of Florida. IFAS Extension. <https://ffl.ifas.ufl.edu/>

Maintenance of Historic Buildings

Caring for Your Old House: A Guide for Owners and Residents. Judith L. Kitchen. National Trust for Historic Preservation. John Wiley & Sons, Inc. 1991.

Maintaining Your Historic Home: A Practical Guide for Homeowners. Delaware County Pennsylvania Planning Department. August 2009.

Maps

Sanborn Fire Insurance Company Maps. Lakeland History Room, Lakeland Public Library (1922, 1929, 1929 with 1935 updates, and 1929 with 1946 updates). 1903-1922 maps available online at <https://ufdc.ufl.edu/contains/?t=%22Insurance+-maps+of+Lakeland%2c+Florida%22&f=TI>

Sustainability & Energy Efficiency

Conservation and Repair work. Peter Clement. <http://buildingconservation.com/articles/metalwin/metalw.htm>

Consumer Product Safety Commission EPA And the American Lung Association. <http://www.cpsc.gov/cpscpub/pubs/453.html>

Energy Star. www.energystar.gov

Environment, Health and Safety online. <http://www.ehso.com/ehshome/asbestoshomeshingles.php>

Florida Green Building Coalition. www.floridagreenbuilding.org

Keeping a Lid on It: Asbestos Cement Building Materials. Amy Lamb Woods. <http://www.nps.gov/history/hps/tps/recentpast/asbestosarticle.htm>

Lakeland Electric Home Energy Audit. <https://lakelandelectric.com/customers/programs-services/energy-audit>

National Park Service, Technical Preservation Services. Sustainability. <https://www.nps.gov/tps/sustainability.htm>

U.S. Green Building Council. Leadership in Energy and Environmental Design (LEED) program. <https://www.usgbc.org/leed>

Whole Building Design Guide. www.wbdg.org

Windows

(See Preservation Brief Nos. 9, 13, and 33. <https://www.nps.gov/tps/how-to-preserve/briefs.htm>)

Save America's Windows, 2nd Edition. John Leeke.
CreateSpace Independent Publishing. January 2009.

Saving Windows, Saving Money: Evaluating
the Energy Performance of Window Retrofit
and Replacement. National Trust for Historic
Preservation, Preservation Green Lab. 2012.

Window Preservation Alliance Library. Contains
many articles concerning the preservation and res-
toration of historic windows. <https://windowpreservationalliance.org/Library>

Window Preservation Standards. CreateSpace
Independent Publishing. July 2013.